

Product	Transistor / MOSFET	Package	TSMT8	Type	TCR
---------	---------------------	---------	-------	------	-----

1. Components description (Only for reference)

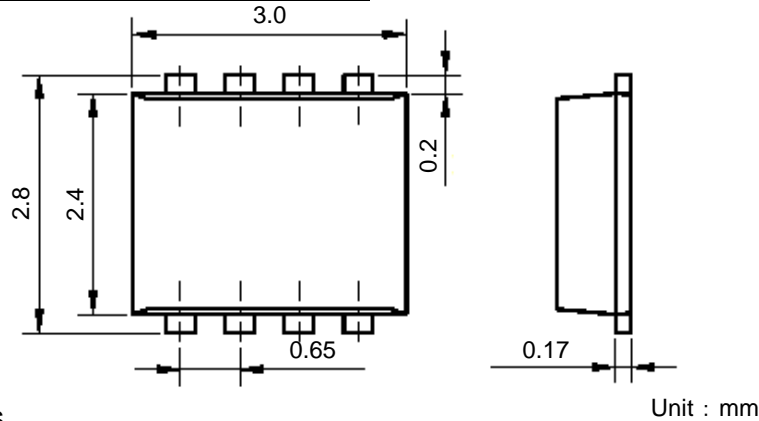

2. Taping dimensions

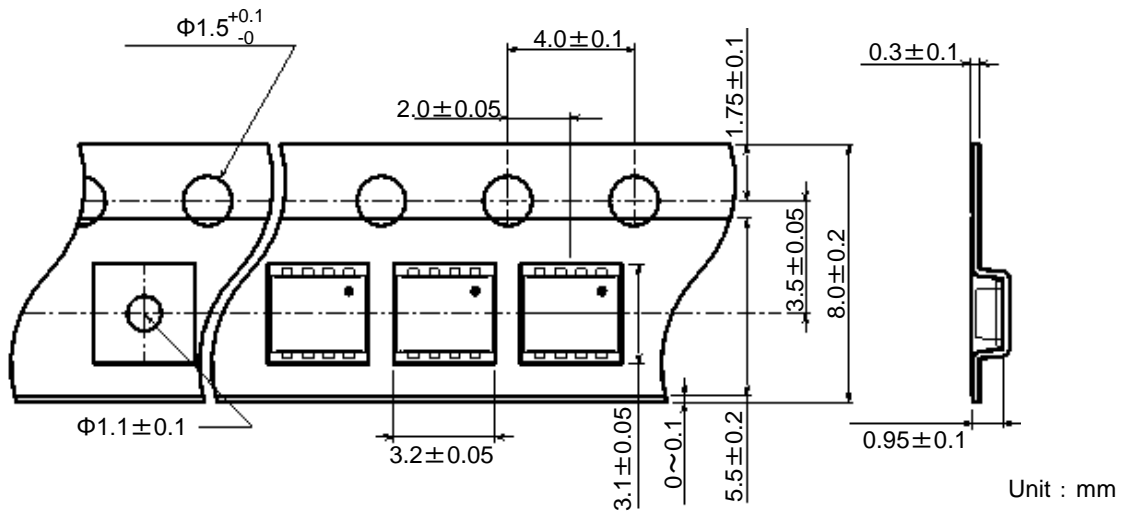

Note) Feed holes might be cover with the adhesive tape, but nothing will affect for using by that.

3. Tape and packing specification

3-1. Direction of tape winding

Connection (1), (2), (3) and (4) comes to feeding hole side. The direction shall be one in a reel.

3-2. Cumulative pitch tolerance

The cumulative pitch tolerance of the mold for producing the carrier tape shall be within $\pm 0.2\text{mm}$ per 10 pitches.

3-3. The minimum radius to bend the carrier tape

Carrier tape shall be flexible enough to protect from no component and damage under a minimum radius of 30mm. However it shall be defined only inside of carrier tape.

3-4. The material of carrier tape

Special carbon paints are coated both sides of polystyrene.

3-5. The material of reel

Polystyrene + Carbon

3-6. Failure Rate

	Incidence	Remark
Continuous missing	0%	Except leader and trail portion
Discontinuous missing	Max.0.1%/reel	

3-7. The part of Emboss

Transistor can fall by its own weight when emboss tape is peeled off then it is reversed.

4. Reeling specification

4-1. Leading direction

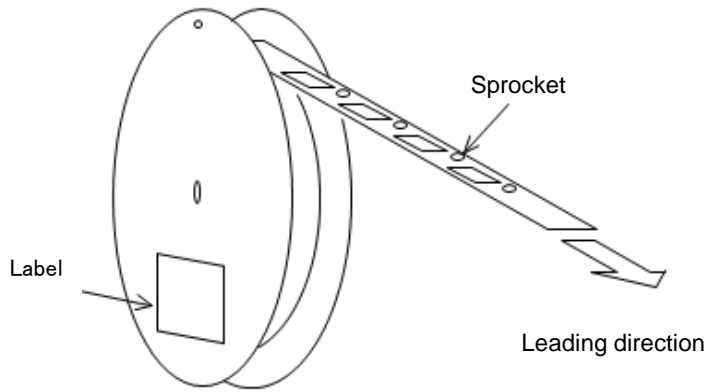

4-2. Leader

Leader tape shall be separated into two parts-an adhesive tape at first part and carrier tape without products.

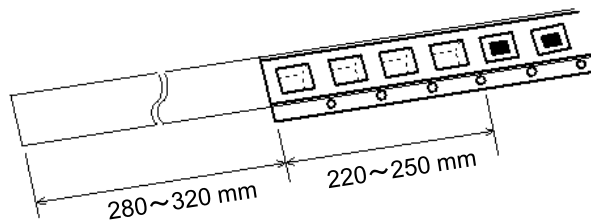

4-3. Trail

Trail tape shall remain with no product and trail tape shall not be stuck directly on a reel.

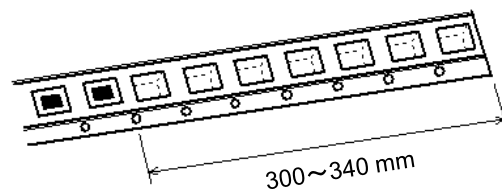

5. Treatment for end of tape

The end of leader tape shall be fixed with the white adhesive tape.

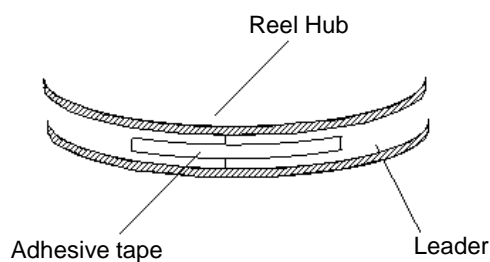

10. Taping Peeling Strength

Peeling strength : 0.1N~1.0N (If products have stored over our recommended storage condition.)

【Test condition (Based on JIS C 0806-3)】

Pull direction at angle from 165°to 180°and pull the seal tape with the speed of 300mm/min±10mm/min.

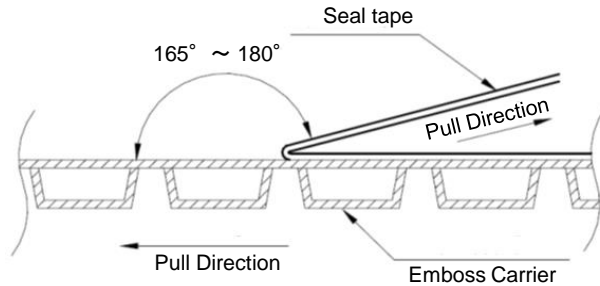

11. Recommended storage condition

Recommended storage condition :

Temperature 5°C - 40°C, Humidity 30%RH - 80%RH

Recommended storage time period :

Five years after production

Notes) It is strongly recommended to confirm solderability before using products of which storage time is exceeding recommended storage time period.

12. Package

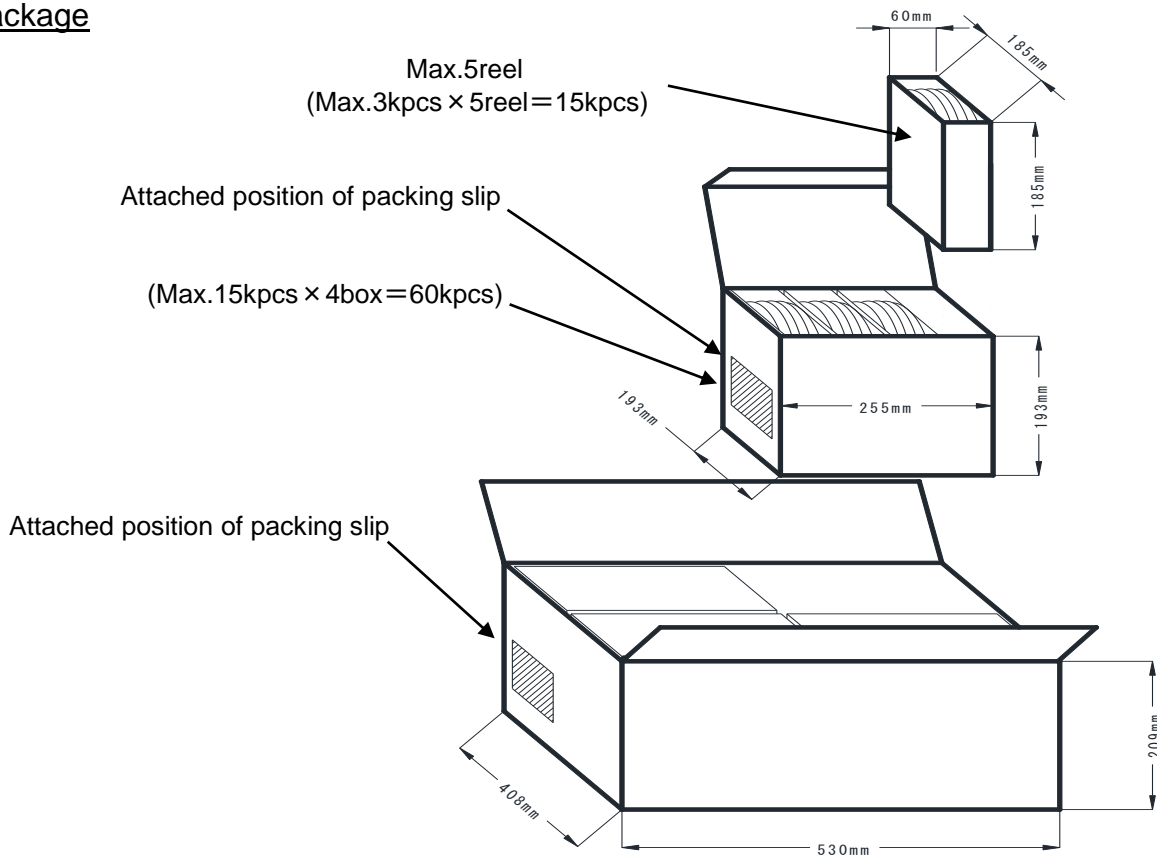

Notes

- 1) The information contained herein is subject to change without notice.
- 2) Before you use our Products, please contact our sales representative and verify the latest specifications.
- 3) Although ROHM is continuously working to improve product reliability and quality, semiconductors can break down and malfunction due to various factors.
Therefore, in order to prevent personal injury or fire arising from failure, please take safety measures such as complying with the derating characteristics, implementing redundant and fire prevention designs, and utilizing backups and fail-safe procedures. ROHM shall have no responsibility for any damages arising out of the use of our Products beyond the rating specified by ROHM.
- 4) Examples of application circuits, circuit constants and any other information contained herein are provided only to illustrate the standard usage and operations of the Products. The peripheral conditions must be taken into account when designing circuits for mass production.
- 5) The technical information specified herein is intended only to show the typical functions of and examples of application circuits for the Products. ROHM does not grant you, explicitly or implicitly, any license to use or exercise intellectual property or other rights held by ROHM or any other parties. ROHM shall have no responsibility whatsoever for any dispute arising out of the use of such technical information.
- 6) The Products are intended for use in general electronic equipment (i.e. AV/OA devices, communication, consumer systems, gaming/entertainment sets) as well as the applications indicated in this document.
- 7) The Products specified in this document are not designed to be radiation tolerant.
- 8) For use of our Products in applications requiring a high degree of reliability (as exemplified below), please contact and consult with a ROHM representative : transportation equipment (i.e. cars, ships, trains), primary communication equipment, traffic lights, fire/crime prevention, safety equipment, medical systems, servers, solar cells, and power transmission systems.
- 9) Do not use our Products in applications requiring extremely high reliability, such as aerospace equipment, nuclear power control systems, and submarine repeaters.
- 10) ROHM shall have no responsibility for any damages or injury arising from non-compliance with the recommended usage conditions and specifications contained herein.
- 11) ROHM has used reasonable care to ensure the accuracy of the information contained in this document. However, ROHM does not warrants that such information is error-free, and ROHM shall have no responsibility for any damages arising from any inaccuracy or misprint of such information.
- 12) Please use the Products in accordance with any applicable environmental laws and regulations, such as the RoHS Directive. For more details, including RoHS compatibility, please contact a ROHM sales office. ROHM shall have no responsibility for any damages or losses resulting non-compliance with any applicable laws or regulations.
- 13) When providing our Products and technologies contained in this document to other countries, you must abide by the procedures and provisions stipulated in all applicable export laws and regulations, including without limitation the US Export Administration Regulations and the Foreign Exchange and Foreign Trade Act.
- 14) This document, in part or in whole, may not be reprinted or reproduced without prior consent of ROHM.



Thank you for your accessing to ROHM product informations.
More detail product informations and catalogs are available, please contact us.

ROHM Customer Support System

<http://www.rohm.com/contact/>

General Precaution

1. Before you use our Products, you are requested to carefully read this document and fully understand its contents. ROHM shall not be in any way responsible or liable for failure, malfunction or accident arising from the use of any ROHM's Products against warning, caution or note contained in this document.
2. All information contained in this document is current as of the issuing date and subject to change without any prior notice. Before purchasing or using ROHM's Products, please confirm the latest information with a ROHM sales representative.
3. The information contained in this document is provided on an "as is" basis and ROHM does not warrant that all information contained in this document is accurate and/or error-free. ROHM shall not be in any way responsible or liable for any damages, expenses or losses incurred by you or third parties resulting from inaccuracy or errors of or concerning such information.