

(A-021-D) DC-AC 3-Phase Vienna PFC (Discrete)

Simulation Parameters (Dialog)

Name	Content	unit	Default Value	Variable Range
L1~3	Inductive Load	H	470u	1n ~ 1
R2~4	Choke Resistance	Ω	5m	1u ~ 100m
C1,C2	Output Capacitor Initial Voltage	F V	1m 400	1n ~ 1 0 ~ 1200
Thcap_MOSFET	Thermal Capacitance	J/K	0.1	1m ~ 100
Rth_MOSFET	Thermal Resistance	K/W	0.3	1m ~ 100
TGND_MOSFET	Thermal GND Temperature	°C	25	-40 ~ 175
Thcap_Diode	Thermal Capacitance	J/K	0.1	1m ~ 100
Rth_Diode	Thermal Resistance	K/W	0.3	1m ~ 100
TGND_Diode	Thermal GND Temperature	°C	25	-40 ~ 175

Simulation Parameters (Table)

Name	Content	unit	Default Value	Variable Range
Test_time	Test time in simulation	s	0.5	100u ~ 0.5
fs	Switching Frequency	Hz	20k	10k ~ 100k
Vin_ac (rms)	Input Voltage Grid Frequency	V Hz	220 50	100 ~ 500 50 or 60
Vout_dc	Output Voltage	V	800	300 ~ 1200
Pout	Output Power	W	15000	1000 ~ 30000
Rg_on*	Gate Resistance (Source)	Ω	10	0.1 ~ 100
Rg_off*	Gate Resistance (Sink)	Ω	10	0.1 ~ 100
T_init**	Initial Junction Temp.	°C	25	-40 ~ 175

*Same value for all MOSFETs

**Same value for all devices

Simulation Circuit

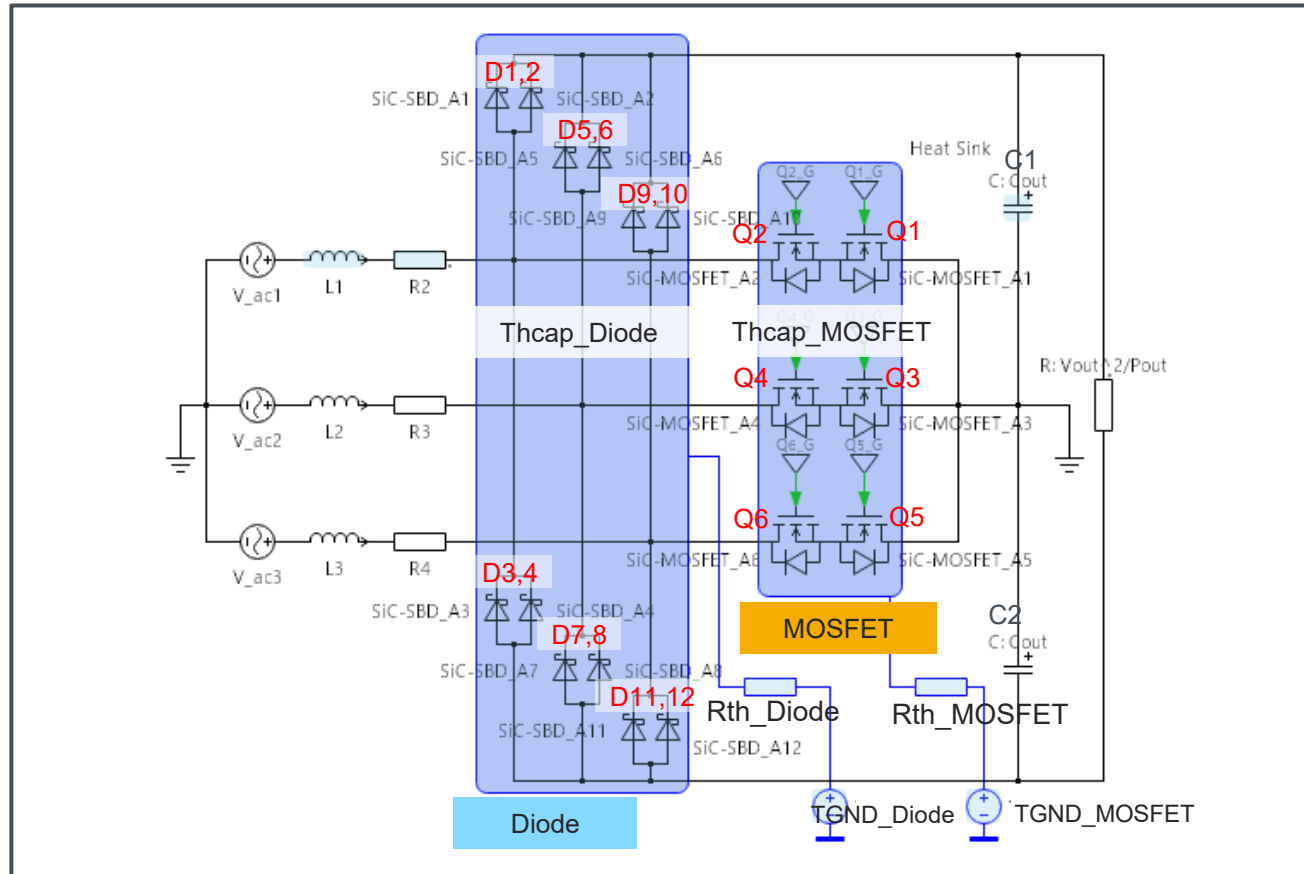

Power Devices

Name	Device Type	Part No.	Specification
Q1~6	SiC MOSFET	SCT4026DR	750V/ 56A/ 26mΩ/ TO-247-4L
D1~12	SiC SBD*	SCS320KG	1200V/ 20A/ TO-220ACGE

*SBD:Schottky Barrier Diode

Simulation Screen Overview

Schematic window

- Dialog parameters setting
- Results display

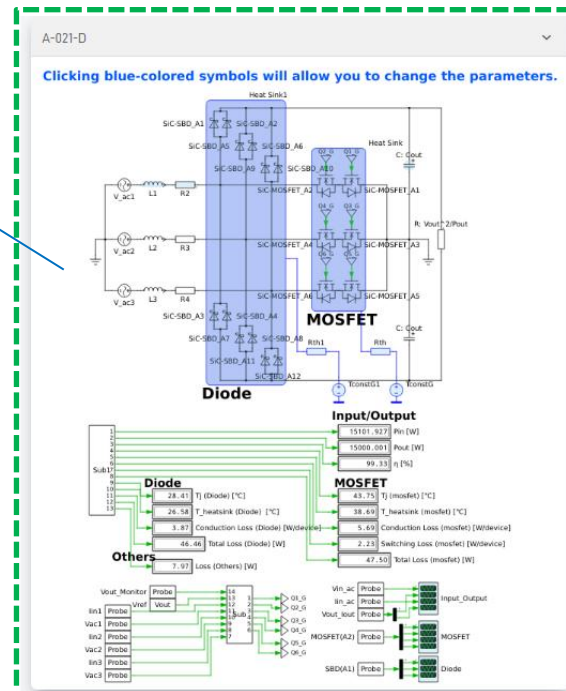

Waveforms

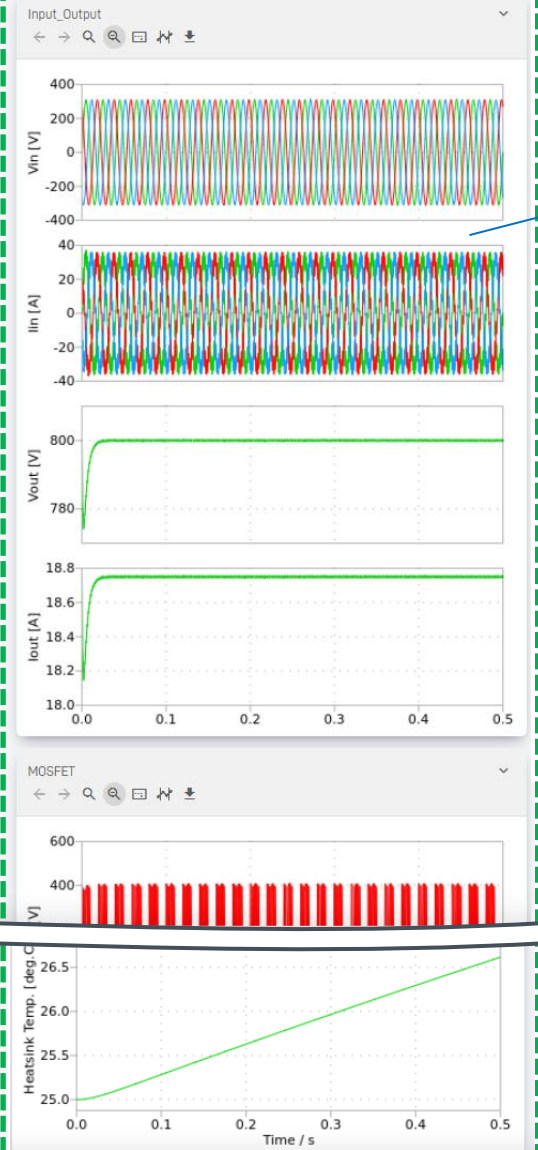

Simulation control

Simulation Control

Start-Up Steady-state Hold Result Simulation Completed

Trace selection

Traces

[file:SCT4026DR], SCS320KG (1200V/20A/TO-220ACGE), Trace 1

Table parameters setting

Parameter	Value	Unit
Rg_on	10	ohm
Rg_off	10	ohm
Initial Junction Temperature	25	deg.C

Simulation Results

Simulation Mode: Steady State

2026 May
68UG104E Rev.002

Input and Output

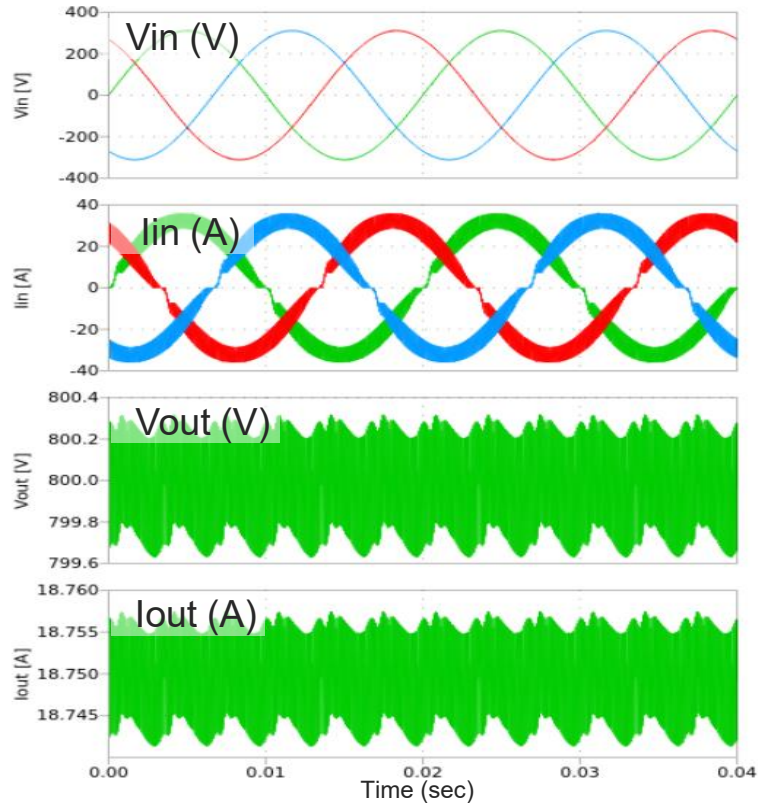

Contents	Results
Input Power : Pin	15.104 (kW)
Output Power: Pout	15.000 (kW)
Efficiency: η	99.31 (%)

MOSFET

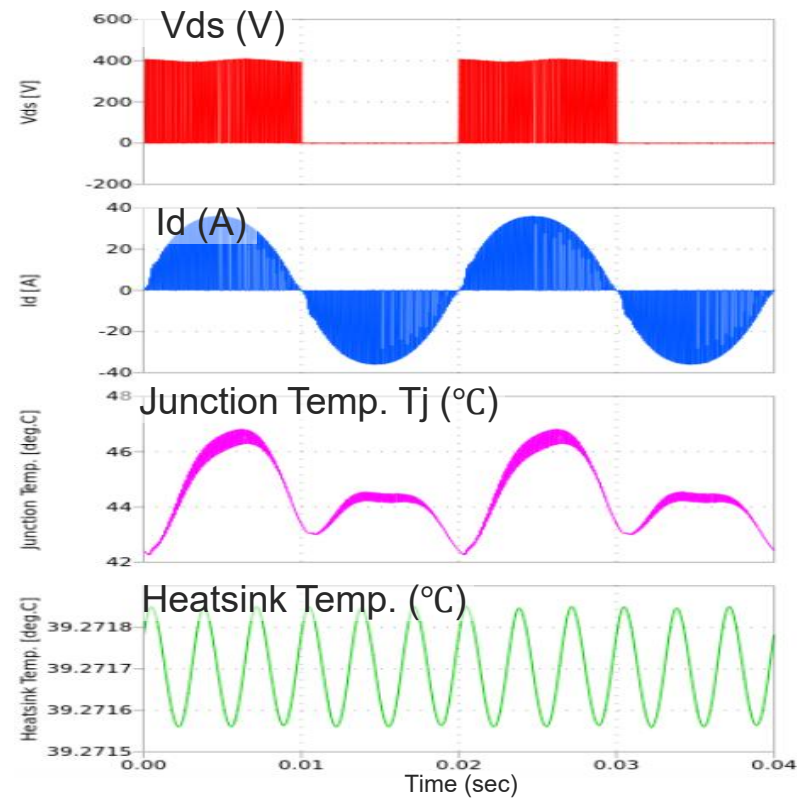

Contents	Results
Junction Temp. Tj(mosfet)	44.42 (°C)
Heatsink Temp. T_hs(mosfet)	39.27 (°C)
Conduction Loss: Pcond(mosfet)	5.70 (W/device)
Switching Loss: Psw(mosfet)	2.23 (W/device)
Total Loss: Ptot (mosfet)	47.58 (W)

Diode

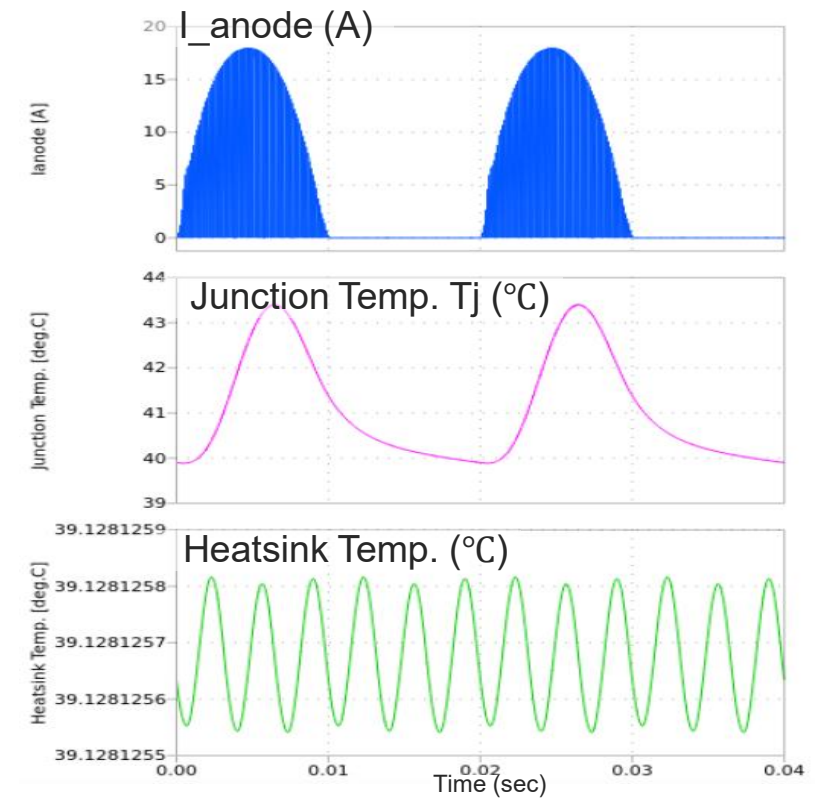

Contents	Results
Junction Temp. Tj(diode)	41.06 (°C)
Heatsink Temp. T_hs(diode)	39.13 (°C)
Conduction Loss: Pcond(diode)	3.92 (W/device)
Total Loss: Ptot(diode)	47.10 (W)

How to change the devices

The figure of "(A-011-D) DC-AC Totem-Pole PFC Diode Rectification (Discrete)" is used as an example in this page.

You can select the simulation devices at "Step-2: Device Selection"

Step 2: Device Selection

Please check the checkboxes of the devices you want to simulate (Square checkboxes allow you to select up to three devices simultaneously.)

You can also select IDEAL devices (no-loss).

In addition, clicking PDF icon will allow you to view the datasheet of the certain device.

SIC-MOSFET Block

Selected: 1/3 SCS320AG

Select	Part Number	VDS [V]	Drain Current [A]	R _{DS(on)} [mΩ] (Typ.)	Package
<input type="checkbox"/>	SCT4090KWA	200	17	90.0	TO-263-7LA
<input type="checkbox"/>	SCT4090KR	200	19	90.0	TO-247-4L
<input type="checkbox"/>	SCT4090KE	200	19	90.0	TO-247N
<input type="checkbox"/>	SCT4065DWA	750	22	65.0	TO-263-7LA
<input checked="" type="checkbox"/>	SCT4065DR	750	25	65.0	TO-247-4L
<input type="checkbox"/>	SCT4065DLL	750	26	65.0	TOLL
<input type="checkbox"/>	SCT4065DE	750	25	65.0	TO-247N
<input type="checkbox"/>	SCT4065W	200	24	62.0	TO-263-7LA

SIC-SBD Block

Selected: SCS320AG

Select	Part Number	Reverse Voltage [V]	Continuous Forward Current [A]	Package
<input type="radio"/>	SCS320KN	1000	20.0	TO-263-2L
<input type="radio"/>	SCS320KG	1000	20.0	TO-220AC
<input type="radio"/>	SCS320AM	600	20.0	TO-220FM
<input type="radio"/>	SCS320AJ	600	20.0	LPTL
<input checked="" type="radio"/>	SCS320AG	600	20.0	TO-220ACGE
<input type="radio"/>	SCS315KN	1000	15.0	TO-263-2L

Selected Products

- SIC-MOSFET SCS320AG
- SIC-SBD SCS320AG

Selected device names are shown here.

SCT4065DR
N-channel SiC power MOSFET

V _{DSS}	750V
R _{DS(on)} (Typ.)	65mΩ
I _D ⁻¹	25A
P _D	88W

Outline
TO-247-4L

Inner circuit

Please note Driver Source and Power Source are not exchangeable. Their exchange might lead to malfunction.

How to change Dialog parameters

The figure of "(A-011-D) DC-AC Totem-Pole PFC Diode Rectification (Discrete)" is used as an example in this page.

- Symbols whose parameters can be changed are colored light-blue in the circuit diagram.
- Over your mouse cursor to the symbol that you want to change the parameter and the symbol color is turned to blue (e.g. "V_ac" symbol in the below).
- Click the mouse's left button.



- A new window like the below is opened.
- You can change the parameters by entering the value directly* or selecting radio buttons.
- Push "Apply" button after changing all parameters.

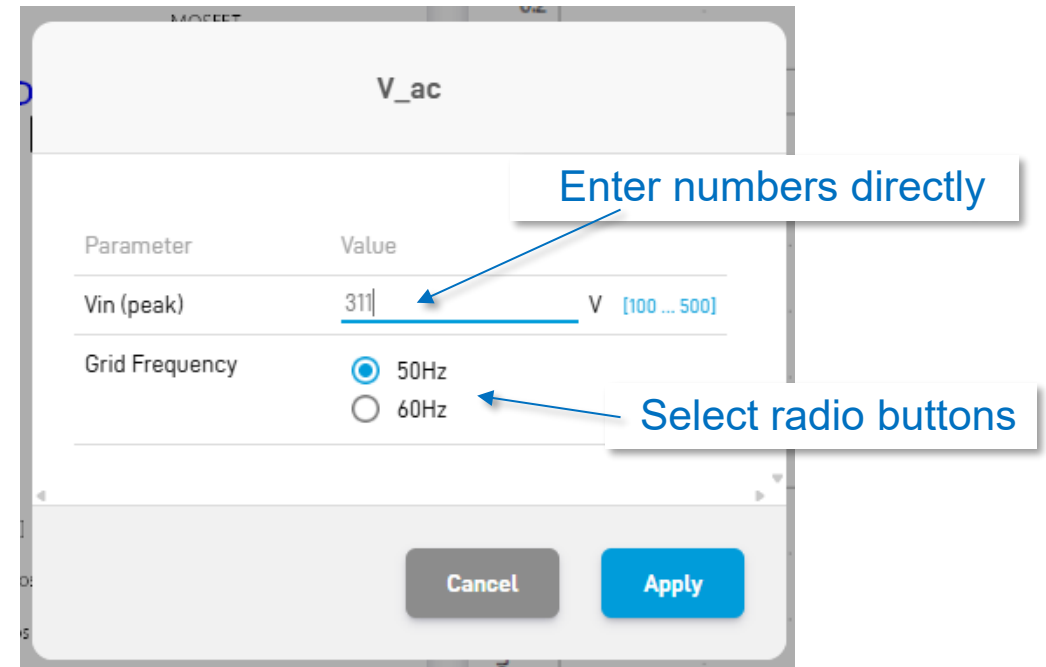

*Note: Parameters can be entered directly are limited by Min. and Max. values to avoid unexpected system errors.
(e.g. "Vin(peak)" is limited between 100 and 500V in the above.)

How to change Table parameters

The figure of "(A-011-D) DC-AC Totem-Pole PFC Diode Rectification (Discrete)" is used as an example in this page.

ROHM PLECS Simulator
Simulation Example



2026 May
68UG104E Rev.002

Table parameters

General Conditions

Parameter	Value
Test_time	1 sec
Switching Frequency	60000 Hz

Device Conditions

General Conditions

Parameter	Value
Test_time	1 sec
Switching Frequency	<u>20000</u> Hz [10000 ... 100000]

Device Conditions

Choose the parameter that you want change on the parameter tables (e.g. "60kHz" of Switching Frequency in the left figure.)

- A blue under-line and variable range of the parameter are appeared.
- Then, you can change the parameters by entering the value directly " (e.g. "60kHz" was changed to "20kHz").

Notice

- 1) The information contained in this document is intended to introduce ROHM Group (hereafter referred to as ROHM) products. When using ROHM products, please verify the latest specifications or datasheets before use.
- 2) ROHM products are designed and manufactured for use in general electronic equipment and applications (such as Audio Visual equipment, Office Automation equipment, telecommunication equipment, home appliances, amusement devices, etc.) or specified in the datasheets. Therefore, please contact the ROHM sales representative before using ROHM products in equipment or devices requiring extremely high reliability and whose failure or malfunction may cause danger or injury to human life or body or other serious damage (such as medical equipment, transportation, traffic, aircraft, spacecraft, nuclear power controllers, fuel control, automotive equipment including car accessories, etc. hereafter referred to as Specific Applications). Unless otherwise agreed in writing by ROHM in advance, ROHM shall not be in any way responsible or liable for any damages, expenses, or losses incurred by you or third parties arising from the use of ROHM Products for Specific Applications.
- 3) Electronic components, including semiconductors, can fail or malfunction at a certain rate. Please be sure to implement, at your own responsibilities, adequate safety measures including but not limited to fail-safe design against physical injury, and damage to any property, which a failure or malfunction of products may cause.
- 4) The information contained in this document, including application circuit examples and their constants, is intended to explain the standard operation and usage of ROHM products, and is not intended to guarantee, either explicitly or implicitly, the operation of the product in the actual equipment it will be used. As a result, you are solely responsible for it, and you must exercise your own independent verification and judgment in the use of such information contained in this document. ROHM shall not be in any way responsible or liable for any damages, expenses, or losses incurred by you or third parties arising from the use of such information.
- 5) When exporting ROHM products or technologies described in this document to other countries, you must abide by the procedures and provisions stipulated in all applicable export laws and regulations, such as the Foreign Exchange and Foreign Trade Act and the US Export Administration Regulations, and follow the necessary procedures in accordance with these provisions.
- 6) The technical information and data described in this document, including typical application circuits, are examples only and are not intended to guarantee to be free from infringement of third parties intellectual property or other rights. ROHM does not grant any license, express or implied, to implement, use, or exploit any intellectual property or other rights owned or controlled by ROHM or any third parties with respect to the information contained herein.
- 7) No part of this document may be reprinted or reproduced in any form by any means without the prior written consent of ROHM.
- 8) All information contained in this document is current as of the date of publication and subject to change without notice. Before purchasing or using ROHM products, please confirm the latest information with the ROHM sales representative.
- 9) ROHM does not warrant that the information contained herein is error-free. ROHM shall not be in any way responsible or liable for any damages, expenses, or losses incurred by you or third parties resulting from errors contained in this document.



Thank you for your accessing to ROHM product informations.
More detail product informations and catalogs are available, please contact us.

ROHM Customer Support System

<https://www.rohm.com/contactus>