

7 V to 76 V Input, 5 A Integrated High-Side MOSFET, Single Buck DC/DC Converter

BD9G500EFJ-LA BD9G500UEFJ-LA

General Description

This product guarantees long time support in industrial market. BD9G500EFJ-LA BD9G500UEFJ-LA is buck DC/DC converter with built-in low on-resistance High-Side power MOSFET. It is capable of providing current of up to 5 A. Current mode architecture provides fast transient response and simple phase compensation setup. The operating frequency is adjustable from 100 kHz to 650 kHz.

Features

- Long Time Support Product for Industrial Applications.
- Wide Input Voltage Range
- Integrated High-Side MOSFET
- Current Mode Control
- Adjustable Frequency
- Soft Start Function
- Over Current Protection (OCP)
- Under Voltage Lockout (UVLO)
- Thermal Shutdown Protection (TSD)
- Over Voltage Protection (OVP)
- HTSOP-J8 package

Applications

- Industrial Equipment
- Power Supply for FA's Industrial Device
- Communications Power Systems

Key Specifications

- Input Voltage Range: 7 V to 76 V
- Input Absolute Maximum Rating: 80 V
85 V (1 ms pulse, 50 % duty or less)
- Reference Voltage Accuracy: 1.0 V ± 1.0 %
- Output Current: 5 A (Max)
- High-Side MOSFET ON-Resistance: 100 mΩ (Typ)
- Shutdown Current: 0 μA (Typ)
- Operating Temperature Range: -40 °C to +125 °C

Package

HTSOP-J8

W (Typ) x D (Typ) x H (Max)

4.9 mm x 6.0 mm x 1.0 mm

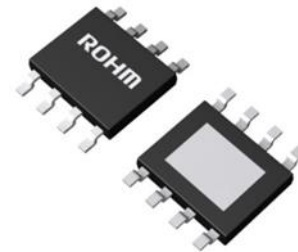

Typical Application Circuits

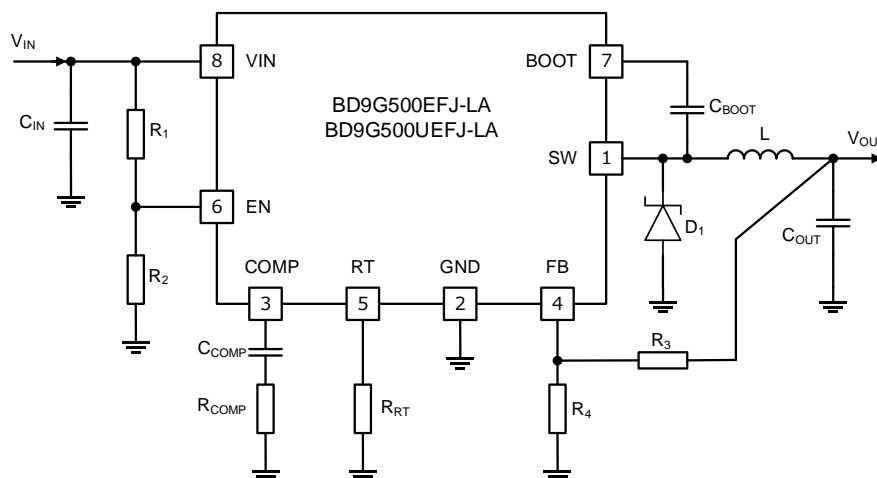

Pin Configuration

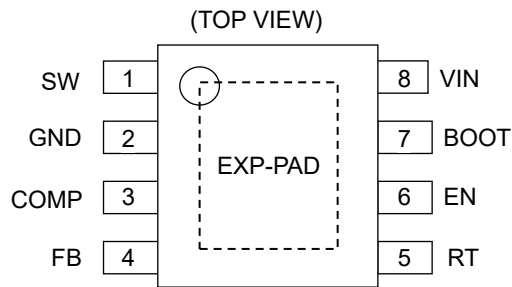

Pin Descriptions

Pin No.	Pin Name	Function
1	SW	Switch pin. This pin is connected to the source of the High-Side MOSFET. Connect a schottky barrier diode between this pin and the GND pin.
2	GND	Ground pin.
3	COMP	Output pin for the gm error amplifier and input to the PWM comparator. Connect phase compensation components to this pin.
4	FB	Output voltage feedback pin. See Selection of Components Externally Connected Output Voltage Set Point for how to calculate the resistance of the output voltage setting.
5	RT	The internal oscillator frequency set pin. The internal oscillator is set with a single resistor connected between this pin and the GND pin. Frequency range is 100 kHz to 650 kHz.
6	EN	Turning this pin signal low (0.4 V or lower) forces the device to enter the shutdown mode. Turning this pin signal high (2.5 V or higher) enables the device. This pin must be terminated.
7	BOOT	Bootstrap pin. Connect a bootstrap capacitor of 1 μF between this pin and the SW pin. The voltage of this capacitor is the gate drive voltage of the High Side MOSFET.
8	VIN	Power supply pin. This pin for the switching regulator and control circuit. Connecting 15 μF and 1 μF ceramic capacitors are recommended.
-	EXP-PAD	A backside heat dissipation pad. Connecting to the internal PCB Ground plane by using via provides excellent heat dissipation characteristics.

Block Diagram

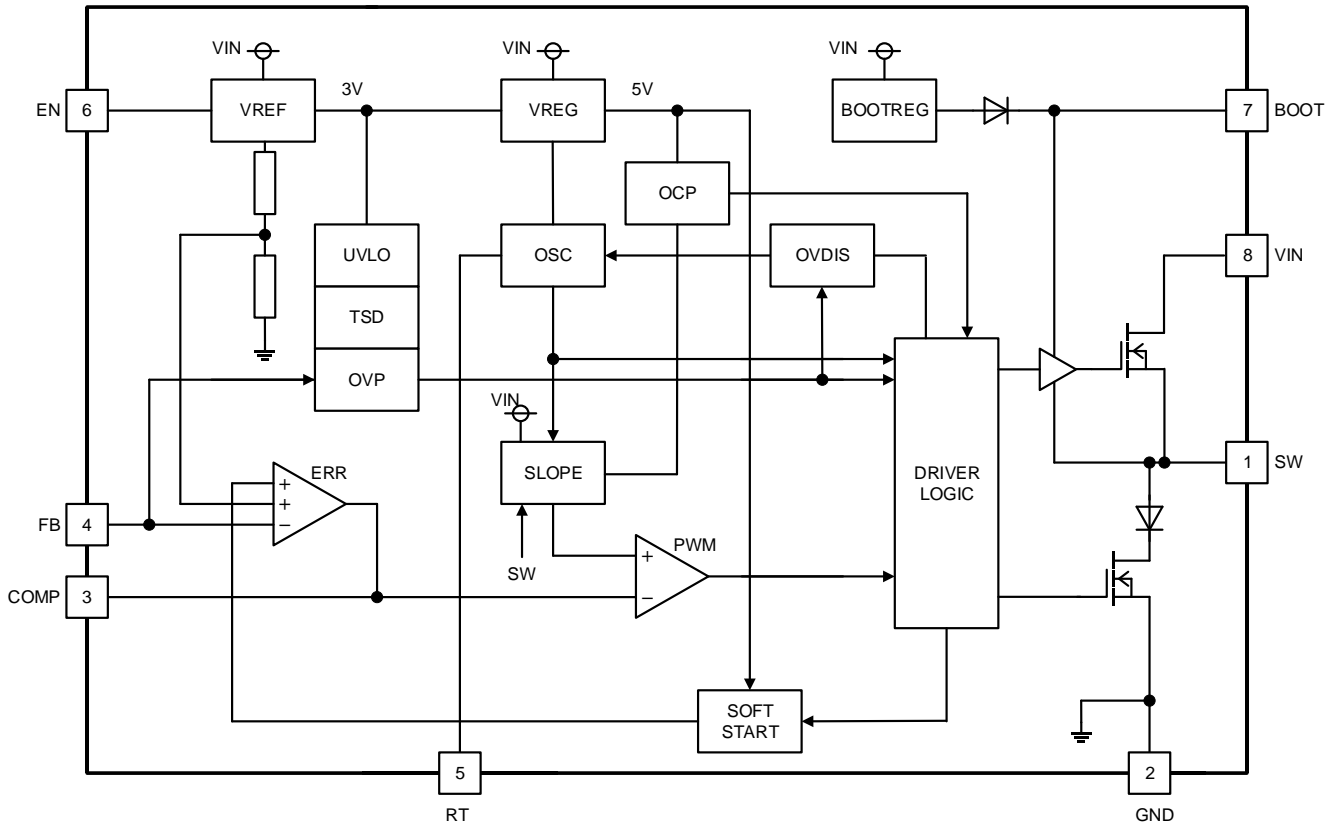

Description of Blocks

- 1 VREF**
Block creating internal reference voltage 3 V (Typ).
- 2 VREG**
Block creating internal reference voltage 5 V (Typ).
- 3 BOOTREG**
Block creating gate drive voltage.
- 4 TSD**
The TSD block is for thermal protection. It shuts down the device when the internal temperature of IC rises to 175 °C (Typ) or more. Thermal protection circuit resets when the temperature falls. The circuit has a hysteresis of 25 °C (Typ).
- 5 UVLO**
This is under voltage lockout block. It shuts down the device when the VIN pin voltage falls to 6.4 V (Typ) or less. The UVLO threshold voltage has a hysteresis of 200 mV (Typ).
- 6 ERR**
The ERR amplifier is the circuit which compares the feedback voltage of the output voltage with the reference voltage. The ERR amplifier output (the COMP pin voltage) determine the switching duty.
- 7 OSC**
Block generating oscillation frequency.
- 8 SLOPE**
Creates delta wave from clock, generated by OSC, and voltage composed by current sense signal of High-Side MOSFET.
- 9 PWM**
Settles the switching duty by comparing the output COMP pin voltage of ERR amplifier and signal of SLOPE block.
- 10 DRIVER LOGIC**
This is DC / DC driver control block. Input signal from PWM and drives MOSFET.
- 11 SOFT START**
The Soft Start circuit slows down the rise of output voltage during start-up and controls the current, which allows the prevention of output voltage overshoot and inrush current.
- 12 OCP**
Current flowing in High-Side MOSFET is controlled one cycle when over current occurs. If OCP function 4 times sequentially, the device stops the operation for 20 ms (Typ) and subsequently initiates a restart.
- 13 OVP**
When the FB pin voltage is 1.2 V (Typ) or more, it turns High-Side MOSFET OFF. After FB pin voltage drops, it returns to normal operation with hysteresis. This IC has Discharge MOS. This MOS turns on 100 ns (Typ) at each duty cycle. When the FB pin voltage is 2.0 V (Typ) or more, it turns Discharge MOS off also.
- 14 OVDIS**
When the FB pin voltage is 1.0 V (Typ) or more and 2.0 V (Typ) or less and remains in that state for 16 cycle, the Discharge MOS On-time is set to 400 ns (Typ) and discharge output voltage.

Absolute Maximum Ratings (Ta = 25 °C)

Parameter	Symbol	Rating	Unit
Input Voltage	V _{IN}	-0.3 to +80.0	V
Input Voltage (1 ms pulse , 50 % duty or less)	V _{INPULSE}	-0.3 to +85.0	V
EN Pin Voltage	V _{EN}	-0.3 to +80.0	V
Voltage from GND to BOOT	V _{BOOT}	-0.3 to +85.0	V
Voltage from SW to BOOT ^(Note 1)	ΔV _{BOOT-SW}	-0.3 to +7.0	V
FB Pin Voltage	V _{FB}	-0.3 to + 7.0	V
COMP Pin Voltage	V _{COMP}	-0.3 to + 7.0	V
RT Pin Voltage	V _{RT}	-0.3 to + 7.0	V
SW Pin Voltage	V _{SW}	-0.5 to V _{IN} + 0.3	V
Maximum Junction Temperature	T _{jmax}	150	°C
Storage Temperature Range	T _{stg}	-55 to +150	°C

Caution 1: Operating the IC over the absolute maximum ratings may damage the IC. The damage can either be a short circuit between pins or an open circuit between pins and the internal circuitry. Therefore, it is important to consider circuit protection measures, such as adding a fuse, in case the IC is operated over the absolute maximum ratings.

Caution 2: Should by any chance the maximum junction temperature rating be exceeded the rise in temperature of the chip may result in deterioration of the properties of the chip. In case of exceeding this absolute maximum rating, design a PCB with thermal resistance taken into consideration by increasing board size and copper area so as not to exceed the maximum junction temperature rating.

(Note 1) Because this IC Voltage from SW to BOOT absolute maximum rating is 7.0 V, Do not short V_{IN} Pin to BOOT Pin after power ON.

Thermal Resistance^(Note 2)

Parameter	Symbol	Thermal Resistance (Typ)		Unit
		1s ^(Note 4)	2s2p ^(Note 5)	
HTSOP-J8				
Junction to Ambient	θ _{JA}	112.8	24.3	°C/W
Junction to Top Characterization Parameter ^(Note 3)	Ψ _{JT}	6.0	2.0	°C/W

(Note 2) Based on JESD51-2A (Still-Air).

(Note 3) The thermal characterization parameter to report the difference between junction temperature and the temperature at the top center of the outside surface of the component package.

(Note 4) Using a PCB board based on JESD51-3.

(Note 5) Using a PCB board based on JESD51-5, 7.

Layer Number of Measurement Board	Material	Board Size
Single	FR-4	114.3 mm x 76.2 mm x 1.57 mmt

Top	
Copper Pattern	Thickness
Footprints and Traces	70 μm

Layer Number of Measurement Board	Material	Board Size	Thermal Via ^(Note 5)	
			Pitch	Diameter
4 Layers	FR-4	114.3 mm x 76.2 mm x 1.6 mmt	1.20 mm	Φ0.30 mm

Top		2 Internal Layers		Bottom	
Copper Pattern	Thickness	Copper Pattern	Thickness	Copper Pattern	Thickness
Footprints and Traces	70 μm	74.2 mm x 74.2 mm	35 μm	74.2 mm x 74.2 mm	70 μm

(Note 5) This thermal via connects with the copper pattern of all layers.

Recommended Operating Conditions

Parameter	Symbol	Min	Typ	Max	Unit
Input Voltage	V _{IN}	7	-	76	V
Operating Temperature	T _{opr}	-40	-	+125 ^(Note 1)	°C
Output Current	I _{OUT}	0	-	5	A
Output Voltage Range	V _{RANGE}	1.0 ^(Note 2)	-	0.97 × V _{IN} ^(Note 3)	V

(Note 1) T_j must be lower than 150 °C under actual operating environment.

(Note 2) Use it in output voltage setting of which output pulse width does not become 350 ns (Typ) or less.

(Note 3) When f_{osc} = 200 kHz setting, the maximum Output Voltage is close to 0.97 (Typ) × (V_{IN} - R_{ONH} × I_{OUT}).

Electrical Characteristics (Unless otherwise specified T_j = -40 °C to +125 °C, V_{IN} = 48 V, V_{EN} = 3 V)

Parameter	Symbol	Min	Typ	Max	Unit	Conditions
Operating Supply Current	I _{OPR}	-	0.75	1.50	mA	V _{FB} = 3.0 V T _j = 25 °C
Shutdown Current	I _{SD}	-	0	10	μA	V _{EN} = 0 V T _j = 25 °C
FB Threshold Voltage ^(Note 4)	V _{FB}	0.99	1.00	1.01	V	
FB Input Current	I _{FB}	-0.1	0	+0.1	μA	V _{FB} = 1.1V
Switching Frequency Range Using RT Pin	f _{RTOSC}	100	-	650	kHz	T _j = 25 °C
Switching Frequency	f _{OSC}	180	200	220	kHz	T _j = 25 °C RT = 47 kΩ
High-Side MOSFET ON-Resistance	R _{ONH}	-	100	140	mΩ	I _{SW} = -50 mA T _j = 25 °C
Over Current limit ^(Note5)	I _{LIMIT}	6.4	8.0	-	A	Without switching Open Loop
UVLO Threshold Voltage	V _{UVLO}	6.1	6.4	6.7	V	V _{IN} falling
UVLO Hysteresis Voltage	V _{UVLOHYS}	100	200	300	mV	
EN High-Level Input Voltage	V _{ENH}	2.5	-	-	V	
EN Low-Level Input Voltage	V _{ENL}	0	-	0.4	V	
EN Input Current	I _{EN}	1.15	2.30	4.60	μA	V _{EN} = 3 V T _j = 25 °C
Soft Start Time	t _{SS}	15	20	25	ms	

(Note 4) Only tested T_j = 25 °C on outgoing inspection.

(Note 5) No tested on outgoing inspection.

Typical Performance Curves

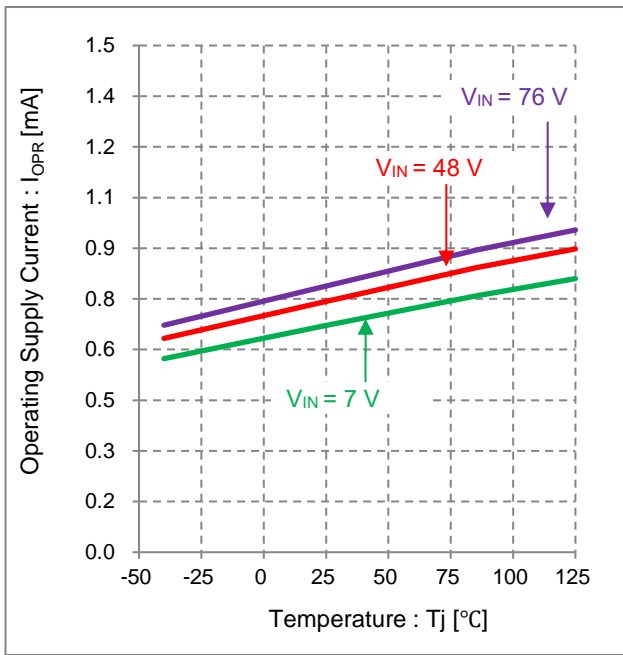

Figure 1. Operating Supply Current vs Temperature

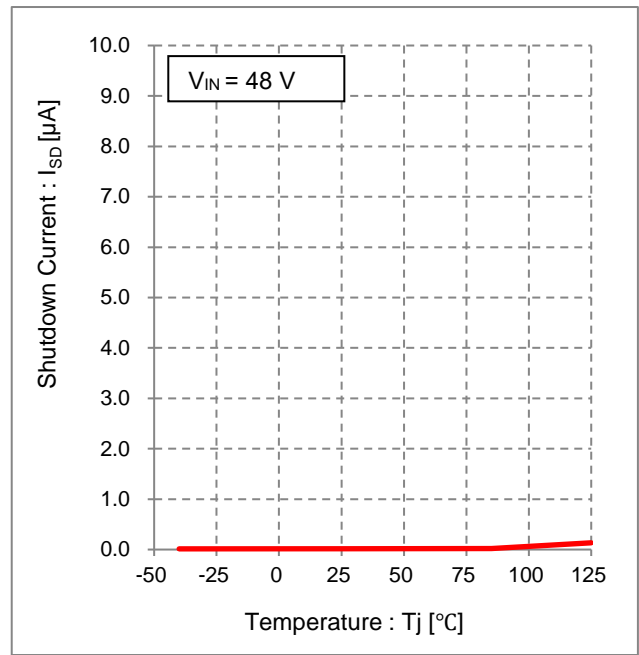

Figure 2. Shutdown Current vs Temperature

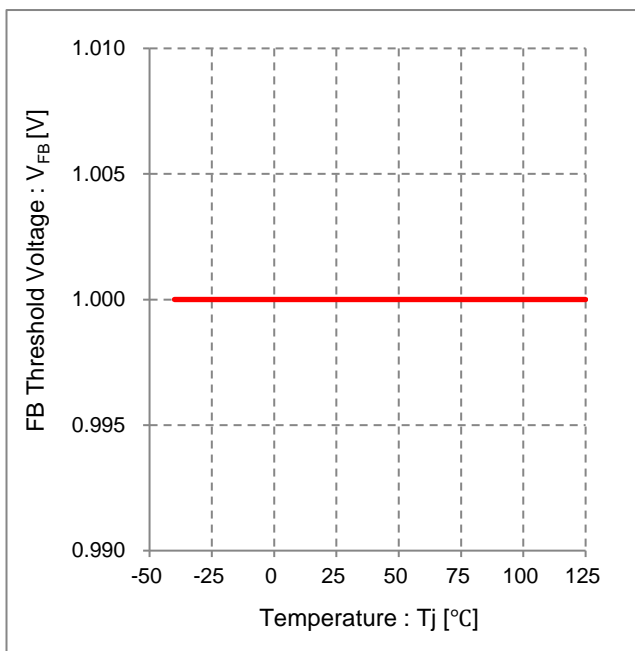

Figure 3. FB Threshold Voltage vs Temperature

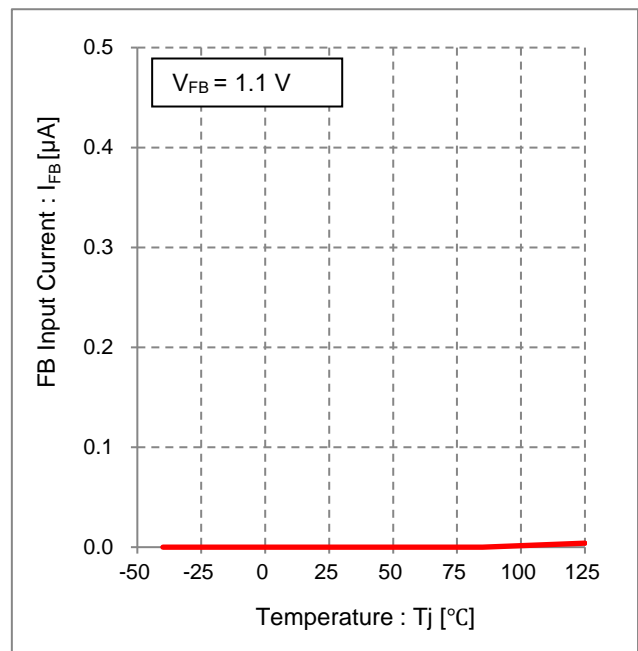

Figure 4. FB Input Current vs Temperature

Typical Performance Curves - continued

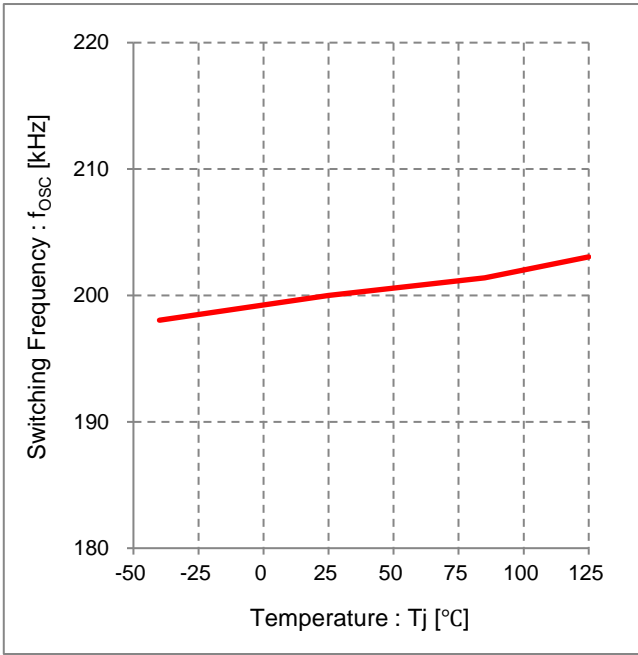

Figure 5. Switching Frequency vs Temperature

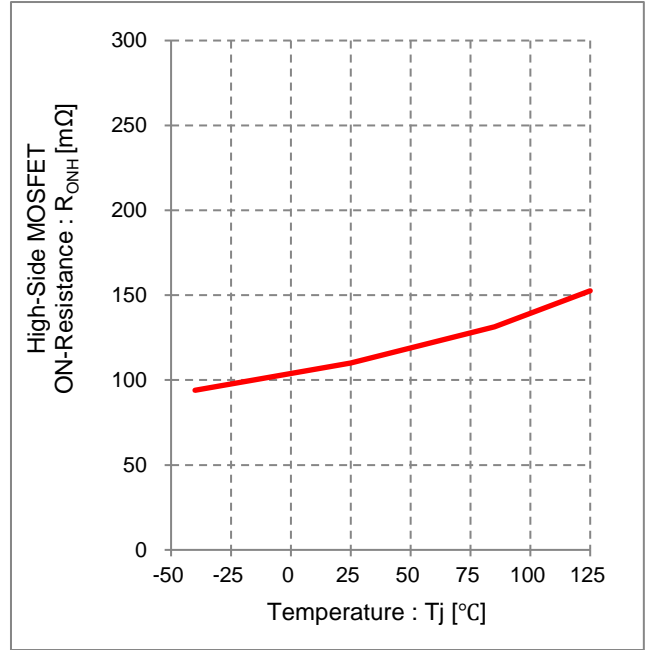

Figure 6. High Side MOSFET ON-Resistance vs Temperature

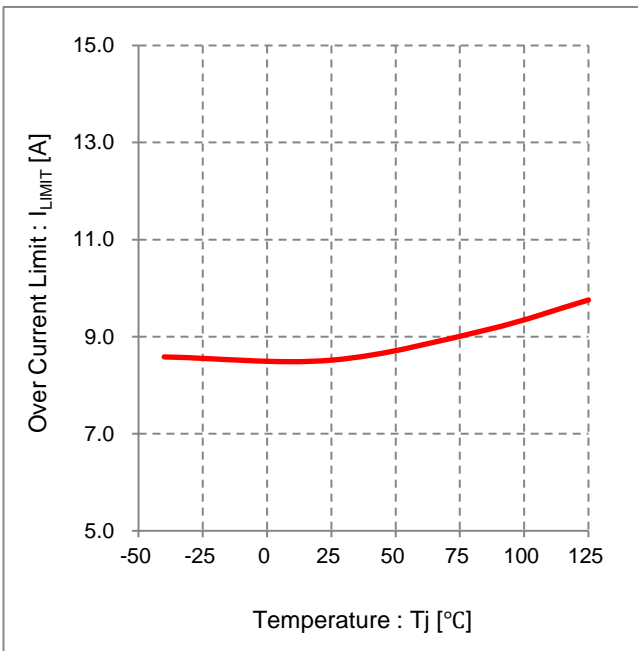

Figure 7. Over Current Limit vs Temperature

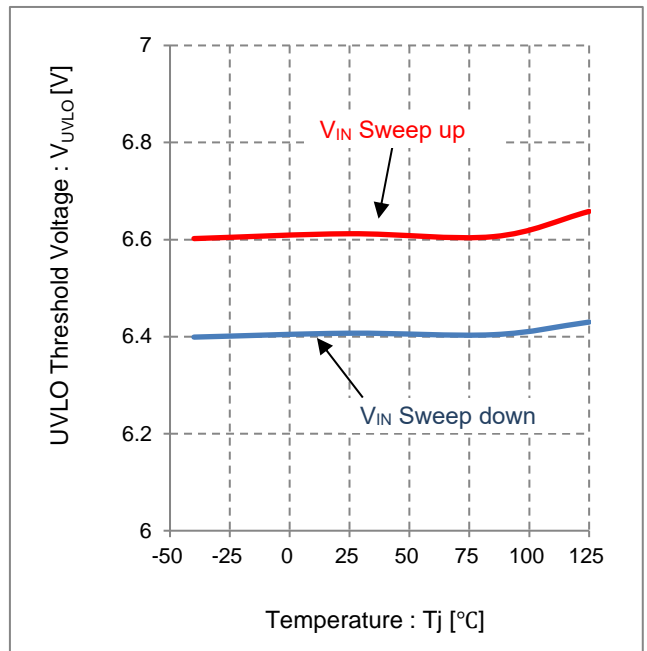

Figure 8. UVLO Threshold Voltage vs Temperature

Typical Performance Curves - continued

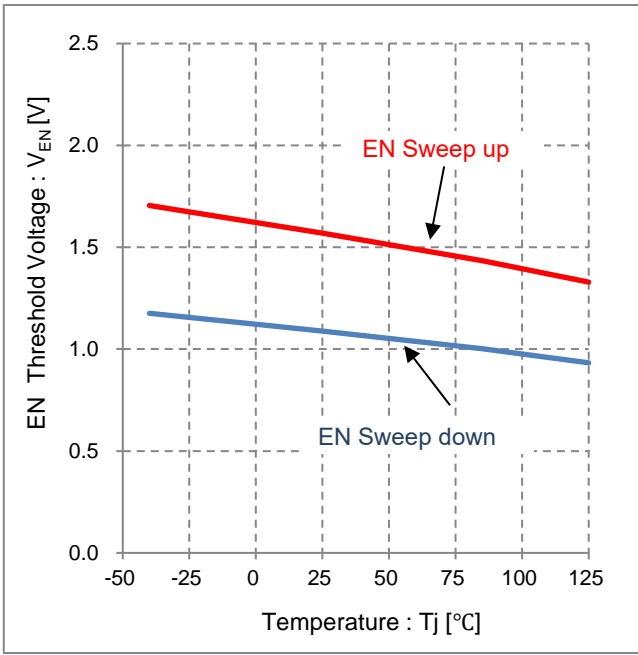

Figure 9. EN Threshold Voltage vs Temperature

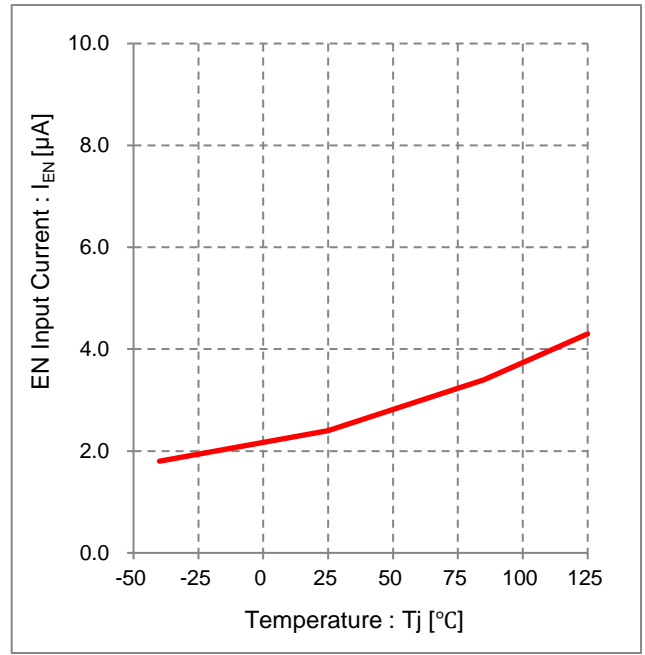

Figure 10. EN Input Current vs Temperature

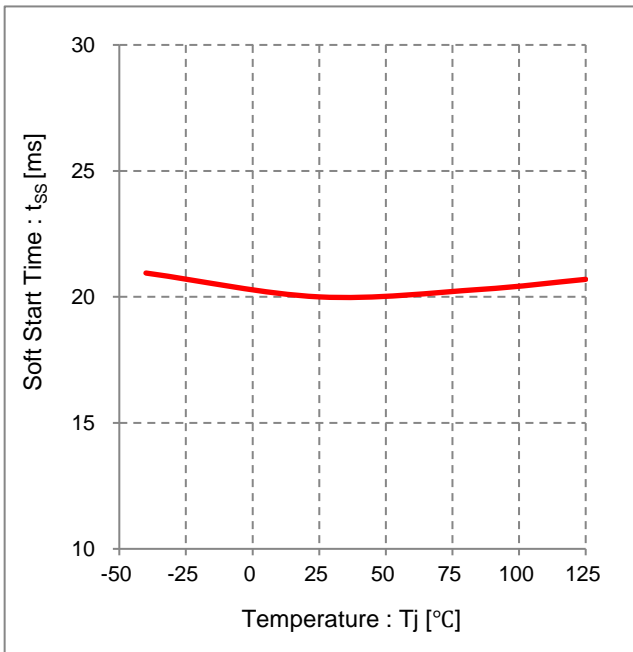

Figure 11. Soft Start Time vs Temperature

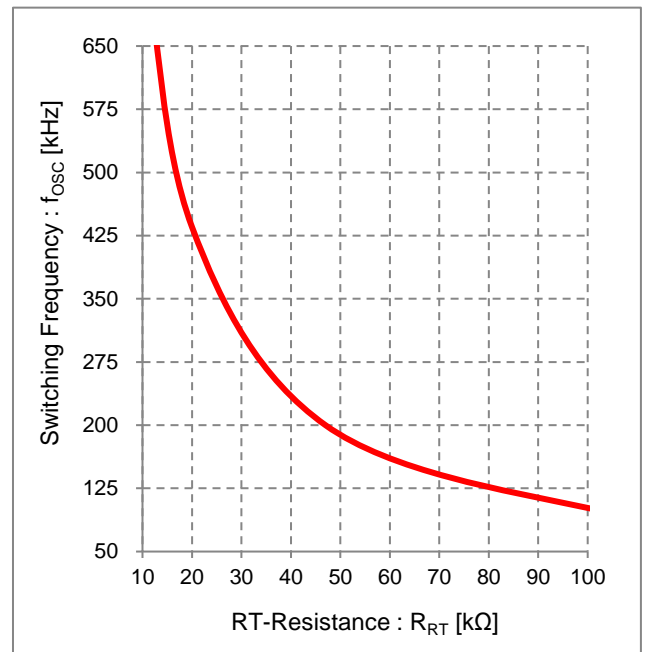

Figure 12. Switching Frequency vs RT-Resistance

Typical Performance Curves (Application)

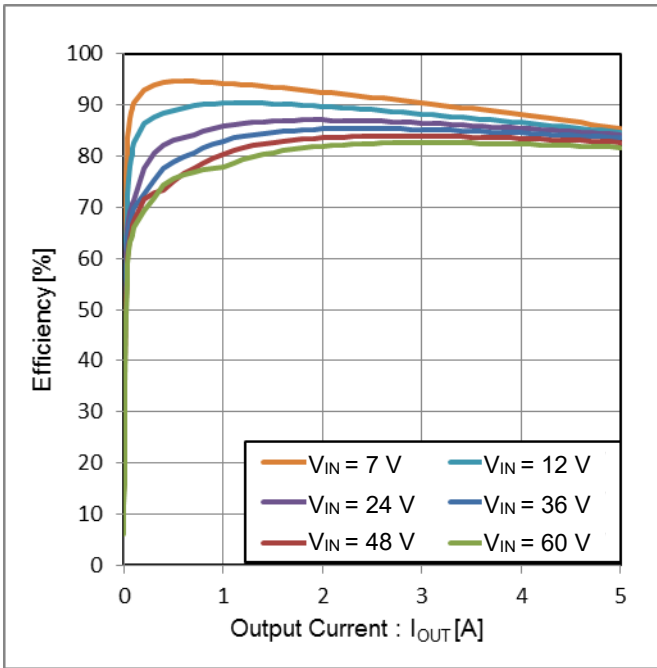

Figure 13. Efficiency vs Output Current
($V_{OUT} = 5.0\text{ V}$, $f_{osc} = 100\text{ kHz}$)

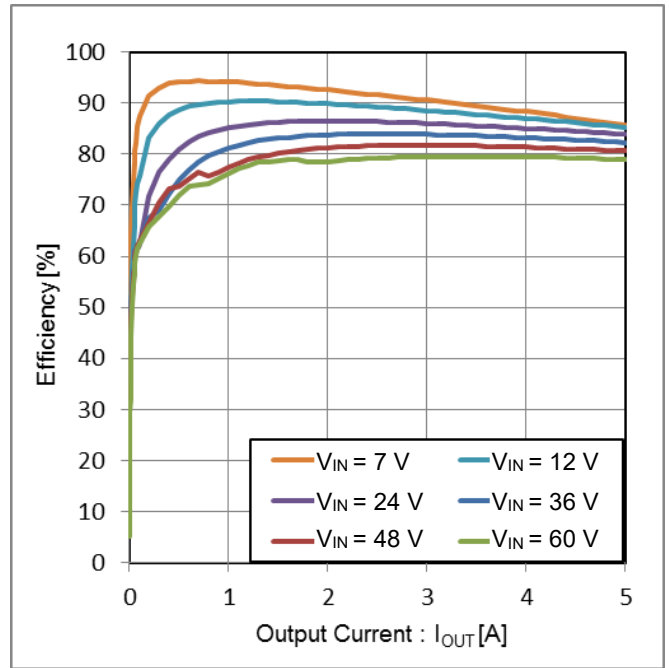

Figure 14. Efficiency vs Output Current
($V_{OUT} = 5.0\text{ V}$, $f_{osc} = 200\text{ kHz}$)

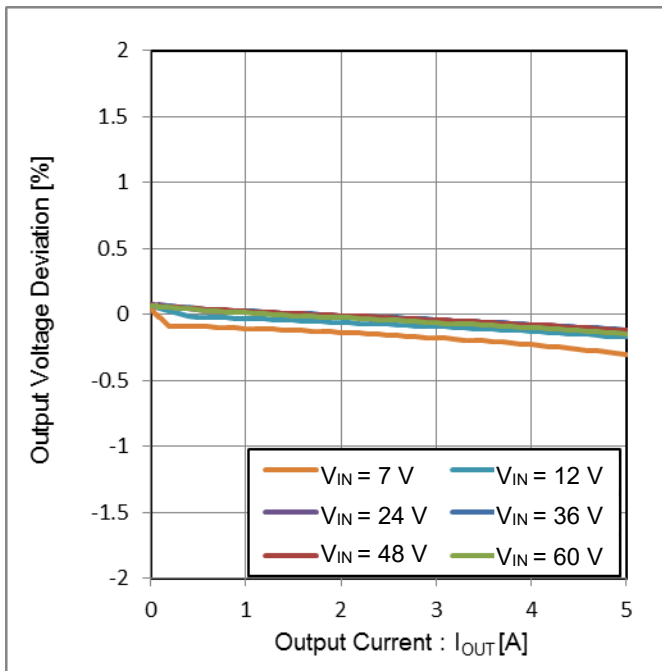

Figure 15. Output Voltage Deviation vs Output Current
(Load Regulation, $V_{OUT} = 5\text{ V}$, $f_{osc} = 100\text{ kHz}$)

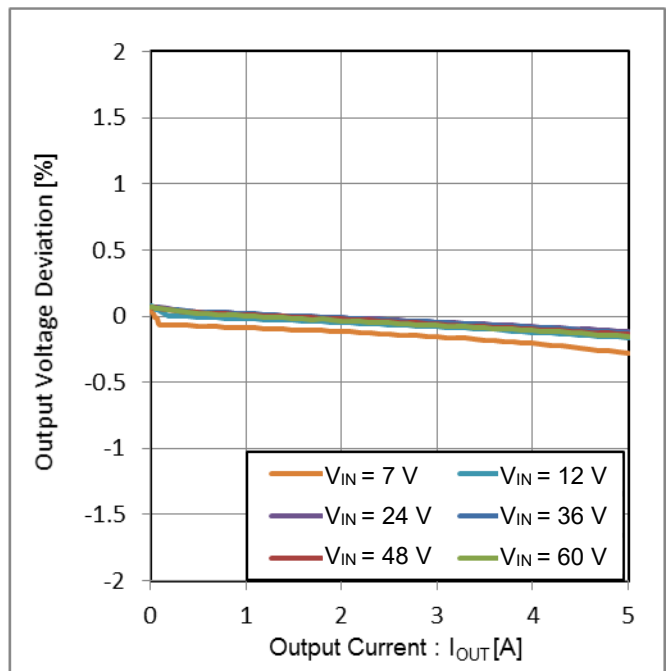

Figure 16. Output Voltage Deviation vs Output Current
(Load Regulation $V_{OUT} = 5\text{ V}$, $f_{osc} = 200\text{ kHz}$)

Typical Performance Curves (Application) - continued

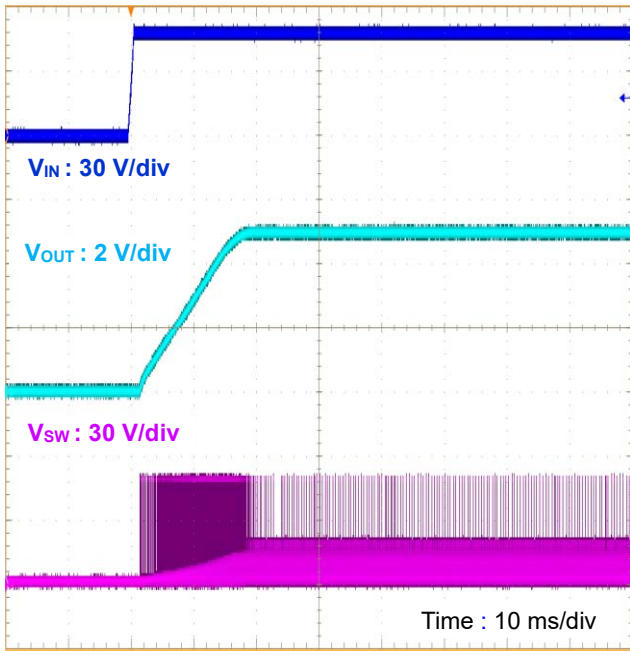

Figure 17. Start-up Waveform
 ($V_{IN} = V_{EN}$, $V_{IN} = 48\text{ V}$, $V_{OUT} = 5\text{ V}$, $f_{osc} = 200\text{ kHz}$, $I_{OUT} = 0\text{ A}$)

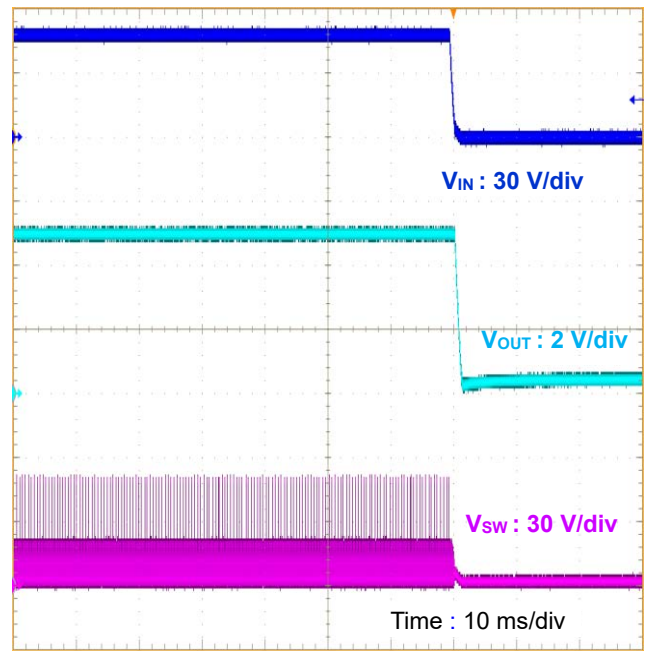

Figure 18. Shutdown Waveform
 ($V_{IN} = V_{EN}$, $V_{IN} = 48\text{ V}$, $V_{OUT} = 5\text{ V}$, $f_{osc} = 200\text{ kHz}$, $I_{OUT} = 0\text{ A}$)

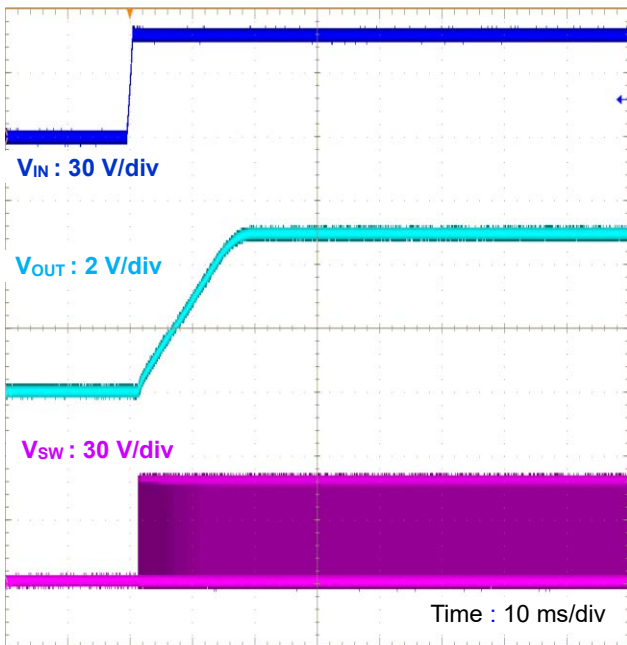

Figure 19. Start-up Waveform
 ($V_{IN} = V_{EN}$, $V_{IN} = 48\text{ V}$, $V_{OUT} = 5\text{ V}$, $f_{osc} = 200\text{ kHz}$, $I_{OUT} = 5\text{ A}$)

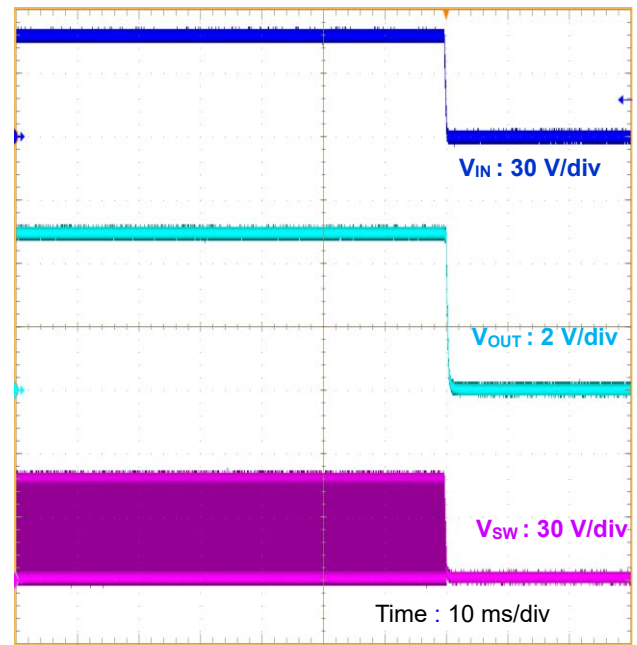

Figure 20. Shutdown Waveform
 ($V_{IN} = V_{EN}$, $V_{IN} = 48\text{ V}$, $V_{OUT} = 5\text{ V}$, $f_{osc} = 200\text{ kHz}$, $I_{OUT} = 5\text{ A}$)

Typical Performance Curves (Application) - continued

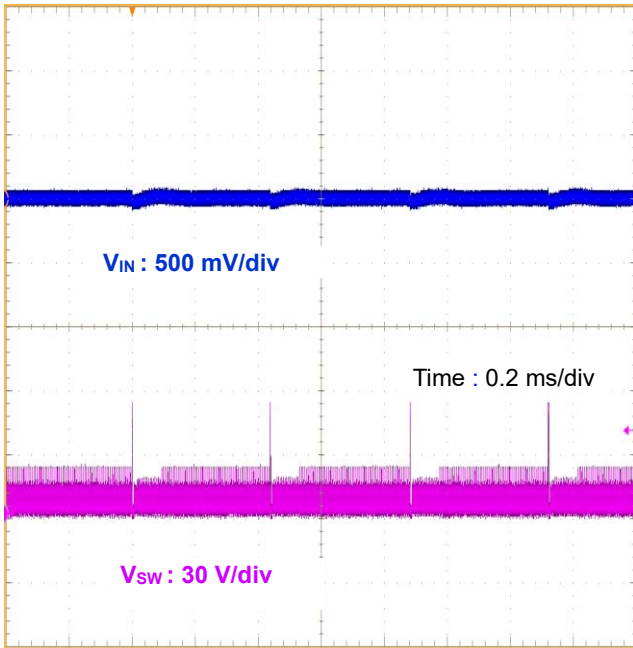

Figure 21. V_{IN} Ripple
 ($V_{IN} = 48 \text{ V}$, $V_{OUT} = 5 \text{ V}$, $f_{osc} = 200 \text{ kHz}$, $I_{OUT} = 0 \text{ A}$)

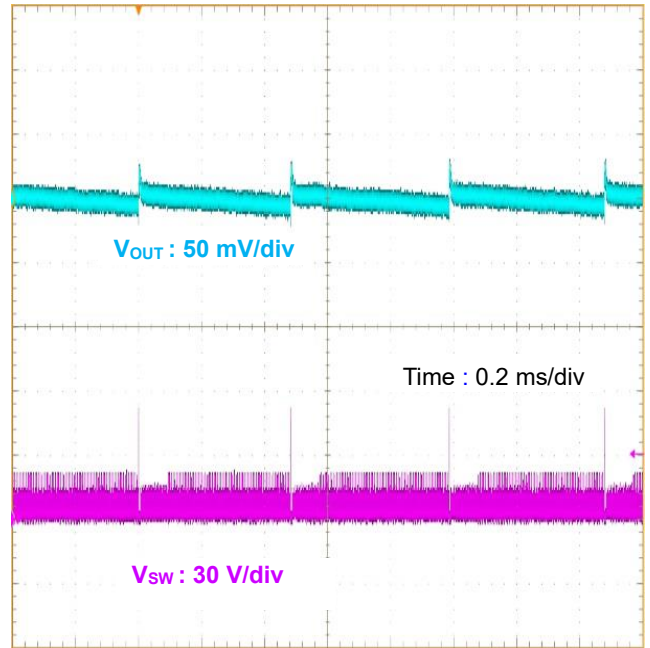

Figure 22. V_{OUT} Ripple
 ($V_{IN} = 48 \text{ V}$, $V_{OUT} = 5 \text{ V}$, $f_{osc} = 200 \text{ kHz}$, $I_{OUT} = 0 \text{ A}$)

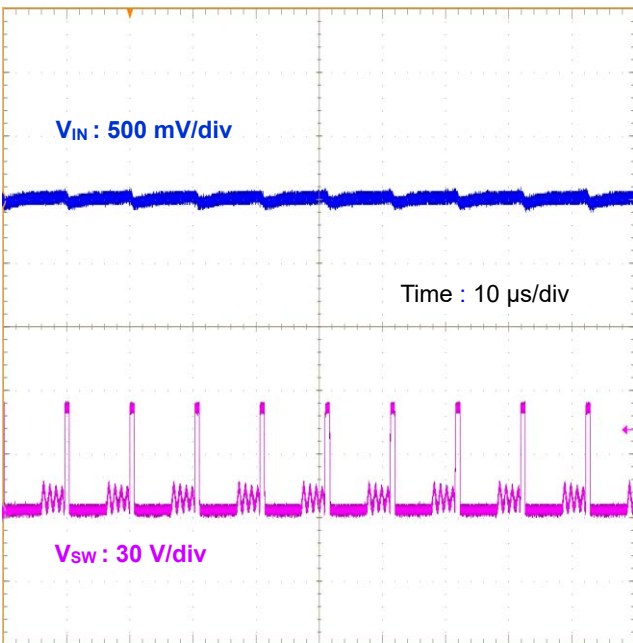

Figure 23. V_{IN} Ripple
 ($V_{IN} = 48 \text{ V}$, $V_{OUT} = 5 \text{ V}$, $f_{osc} = 200 \text{ kHz}$, $I_{OUT} = 0.3 \text{ A}$)

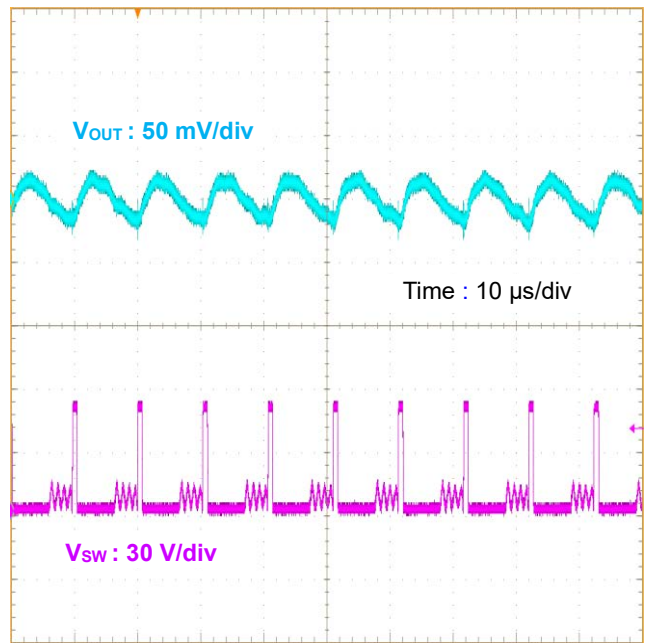

Figure 24. V_{OUT} Ripple
 ($V_{IN} = 48 \text{ V}$, $V_{OUT} = 5 \text{ V}$, $f_{osc} = 200 \text{ kHz}$, $I_{OUT} = 0.3 \text{ A}$)

Typical Performance Curves (Application) - continued

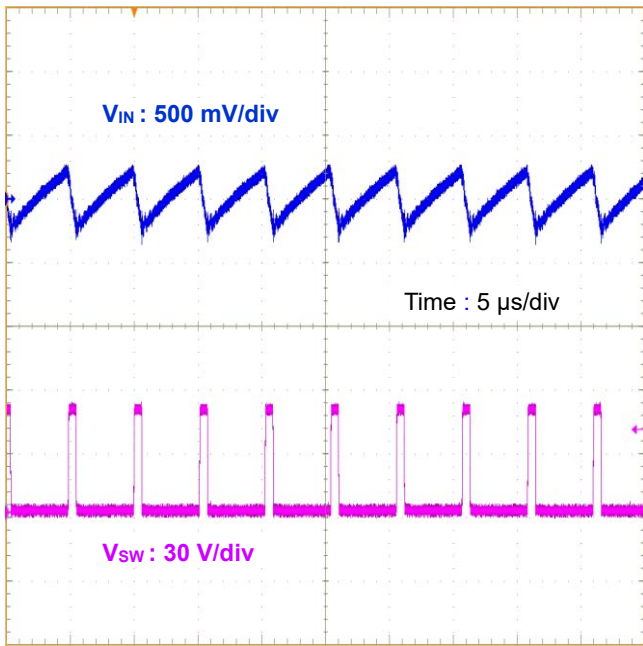

Figure 25. V_{IN} Ripple
 ($V_{IN} = 48\text{ V}$, $V_{OUT} = 5\text{ V}$, $f_{OSC} = 200\text{ kHz}$, $I_{OUT} = 5\text{ A}$)

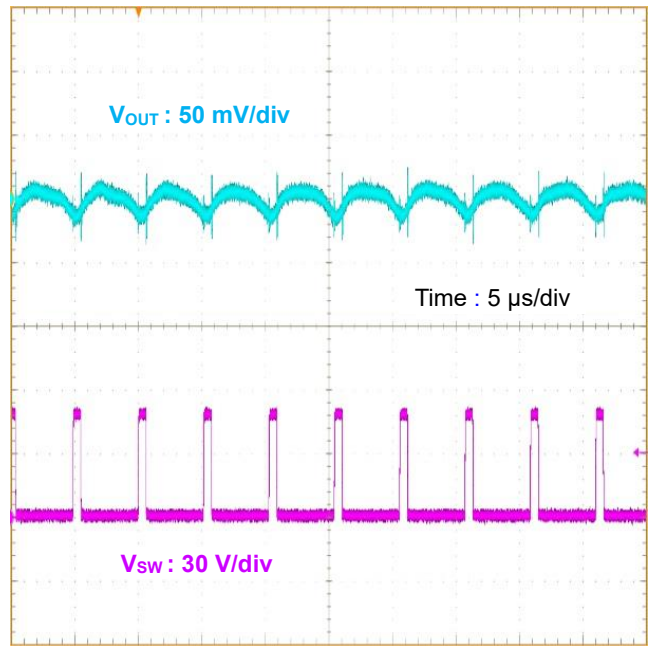

Figure 26. V_{OUT} Ripple
 ($V_{IN} = 48\text{ V}$, $V_{OUT} = 5\text{ V}$, $f_{OSC} = 200\text{ kHz}$, $I_{OUT} = 5\text{ A}$)

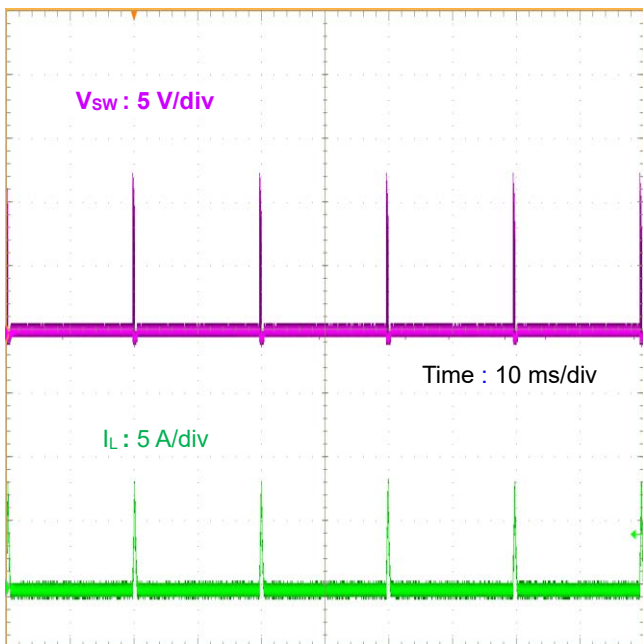

Figure 27. Switching Waveform
 ($V_{IN} = 12\text{ V}$, $V_{OUT} = 5\text{ V}$, $f_{OSC} = 200\text{ kHz}$, V_{OUT} short to GND)

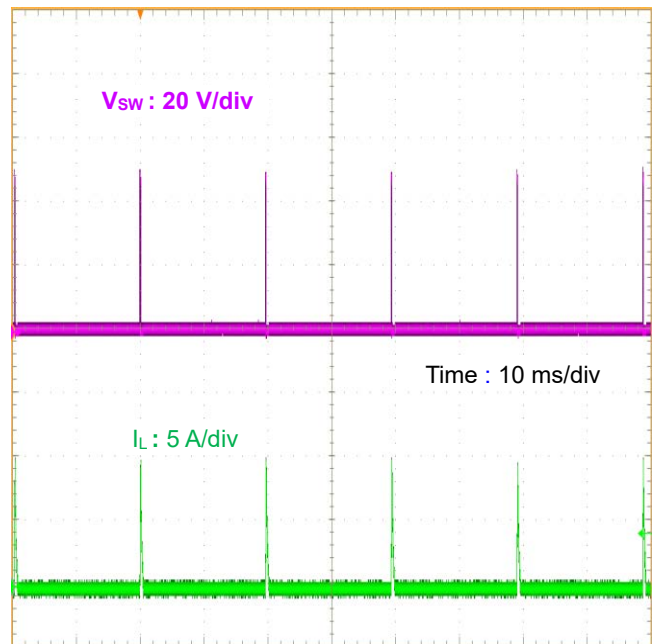

Figure 28. Switching Waveform
 ($V_{IN} = 48\text{ V}$, $V_{OUT} = 5\text{ V}$, $f_{OSC} = 200\text{ kHz}$, V_{OUT} short to GND)

Typical Performance Curves (Application) - continued

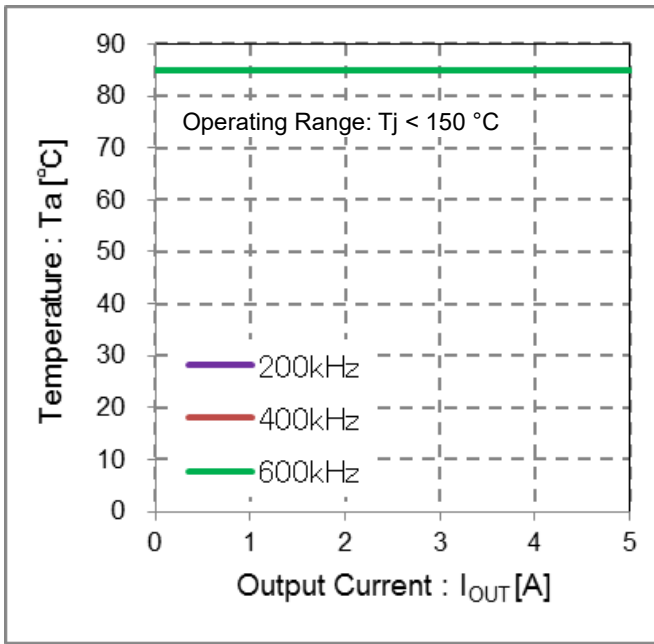

Figure 29. Temperature vs Output Current
($V_{IN} = 48\text{ V}$, $V_{OUT} = 5\text{ V}$, ROHM Board)

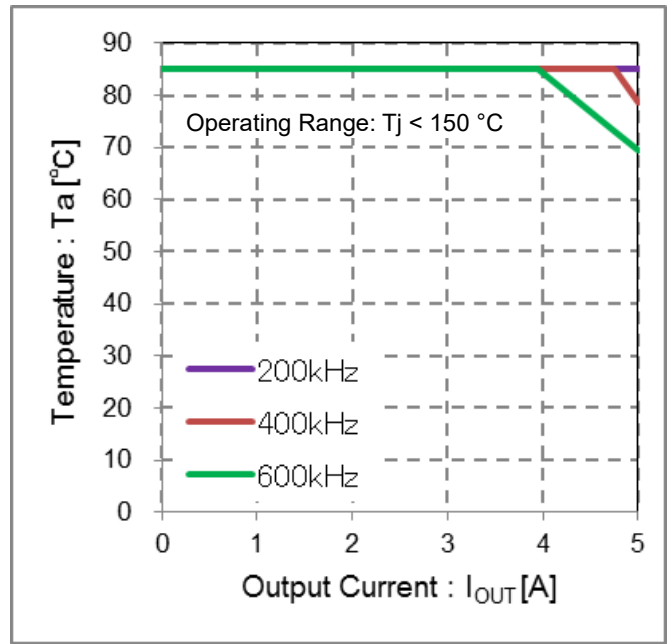

Figure 30. Temperature vs Output Current
($V_{IN} = 48\text{ V}$, $V_{OUT} = 12\text{ V}$, ROHM Board)

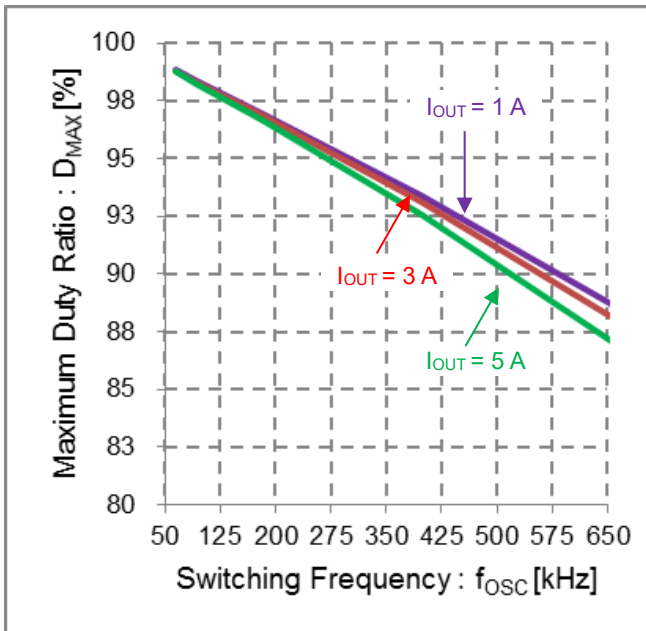

Figure 31. Maximum Duty Ratio vs Switching Frequency
($V_{IN} = 12\text{ V}$)

Function Description

1 Enable Control

The IC shutdown can be controlled by the voltage applied to the EN pin. When the EN pin voltage reaches 2.5 V (Min), the internal circuit is activated and the IC starts up. When EN pin voltage becomes 0.4 V (Max), the device is shutdown. To enable shutdown control with the EN Pin, set the shutdown interval (Low level interval of EN) must be set to 100 μs or more.

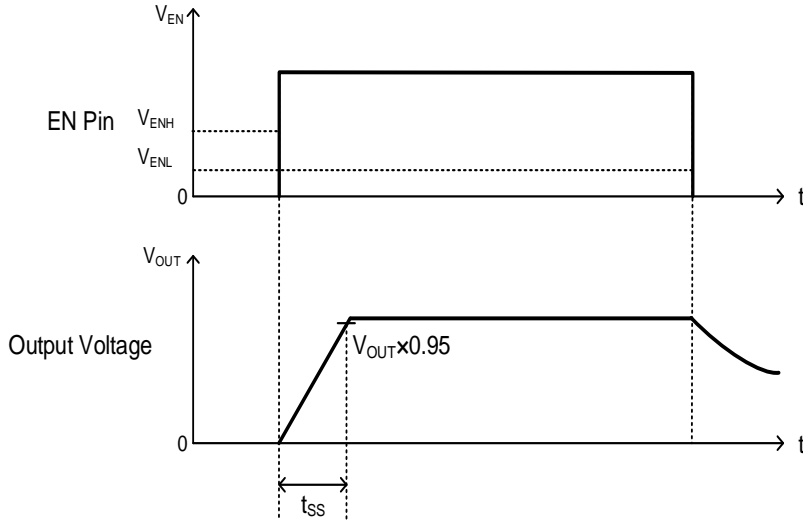

Figure 32. Timing Chart with Enable Control

2 Protective Functions

The protective circuits are intended for prevention of damage caused by unexpected accidents. Do not use them for continuous protective operation.

2.1 Over Current Protection (OCP)

Current flowing in High-Side MOSFET is controlled one cycle when over current occurs. If OCP function 4 times sequentially, the device stops the operation for 20 ms (Typ) and subsequently initiates a restart.

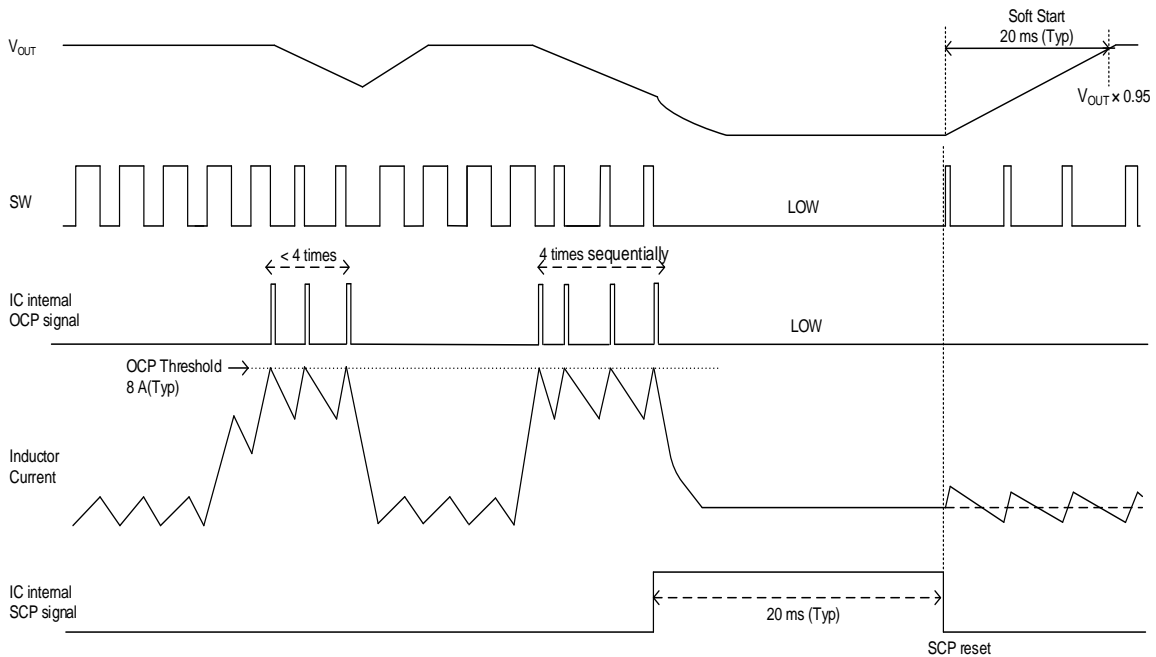

Figure 33. Over Current Protection Timing Chart

2. Protective Functions - continued

2.2 Under Voltage Lockout Protection Function (UVLO)

This is under voltage lockout block. It shuts down the device when the VIN pin voltage falls to 6.4 V (Typ) or less. The UVLO threshold voltage has a hysteresis of 200 mV (Typ).

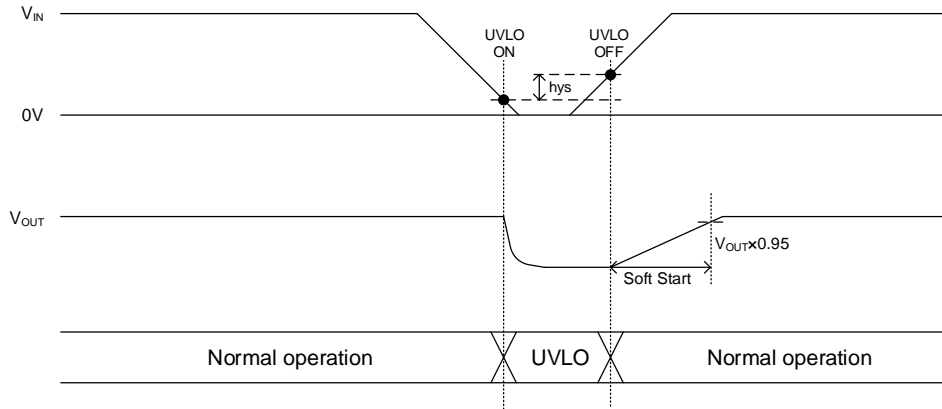

Figure 34. UVLO Timing Chart

2.3 Over Voltage Discharge Function (OVDIS)

When the FB pin voltage is 1.0 V (Typ) or more and 2.0 V (Typ) or less and remains in that state for 16 cycle, the Discharge MOS On-time is set to 400 ns (Typ) and discharge output voltage.

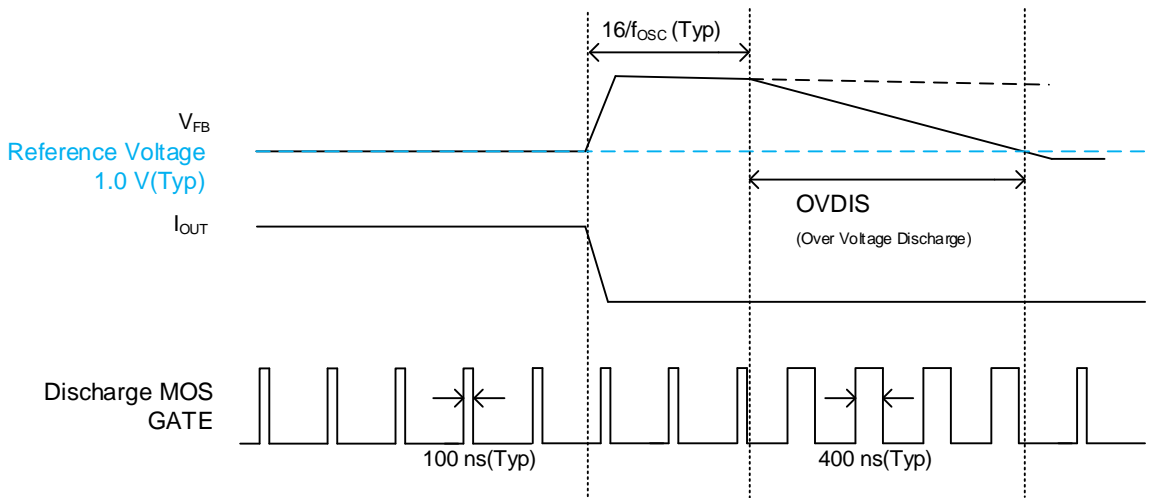

Figure 35. OVDIS Timing Chart

2.4 Over Voltage Protection Function (OVP)

When the FB pin voltage is 1.2 V (Typ) or more, it turns High-Side MOSFET OFF. After FB pin voltage drops, it returns to normal operation with hysteresis. This IC has Discharge MOS. This MOS turns on 100 ns (Typ) at each duty cycle. When the FB pin voltage is 2.0 V (Typ) or more, it turns Discharge MOS off also.

2.5 Thermal Shutdown Function (TSD)

This is the thermal shutdown circuit that prevents heat damage to the IC. Normal operation should always be within the IC's power dissipation rating. However, if the rating is exceeded for a continued period and the junction temperature (Tj) rises to 175 °C (Typ) or more, the TSD circuit will operate and turn OFF the output MOSFET. When the Tj falls below the TSD threshold, the circuits are automatically restored to normal operation. Note that the TSD circuit operates in a situation that exceeds the absolute maximum ratings and therefore, under no circumstances, should the TSD circuit be used in a set design or for any purpose other than protecting the IC from heat damage.

Application Examples

1 $V_{OUT} = 5.0 V$

Table 1. Specification of Application

Parameter	Symbol	Specification Value
Input Voltage	V_{IN}	7 V ~ 48 V
Output Voltage	V_{OUT}	5.0 V
Switching Frequency	f_{OSC}	200 kHz (Typ)
Maximum Output Current	I_{OUTMAX}	5 A

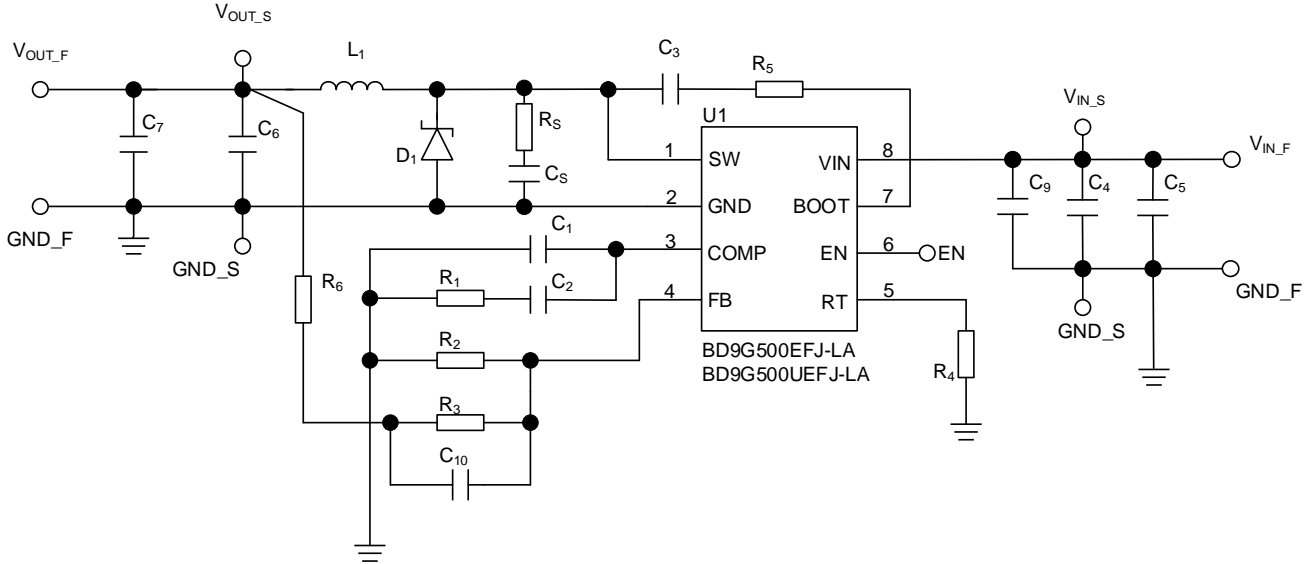

Figure 36. Application Circuit

Table 2. Recommended Component Values^(Note 1) ($V_{OUT} = 5.0 V$)

Part No.	Value	Part Name	Manufacturer
C_4 ^(Note 2)	15 μF / 100 V	KRM55WR72A156MH01L	MURATA
C_9 ^(Note 3)	1 μF / 100 V	GRM21BC72A105KE01L	MURATA
C_3 ^(Note 4)	1 μF / 10 V	GRM155C71A105KE11D	MURATA
C_2	6800 pF / 50 V	GRM1555C1H682JE01D	MURATA
C_6	47 μF / 25 V	KRM55WR71E476MH01L	MURATA
C_7	220 μF / 50 V Aluminum	UBT1H221M	NICHICON
R_1	62 k Ω	MCR03 series	ROHM
R_2	0.75 k Ω	MCR03 series	ROHM
R_3	3 k Ω	MCR03 series	ROHM
R_4	47 k Ω	MCR03 series	ROHM
R_5	0 Ω	MCR03 series	ROHM
R_6	0 Ω	MCR03 series	ROHM
D_1	100 V / 10 A	STPS15H100C	ST
		RB088BM100TL	ROHM
L_1	33 μH	7443551331	WURTH

(Note 1) These recommended component values for small output voltage ripple and improved transient response setting, please confirm on the actual equipment considering variations of the characteristics of the product and external components. Component not in table all for open conditions

(Note 2) For the capacitance of input capacitor, take temperature characteristics, DC bias characteristics, etc. into consideration to set to a minimum value of no less than 4.7 μF .

(Note 3) In order to reduce the influence of high frequency noise, connect a 1 μF ceramic capacitor as close as possible to the VIN pin and the GND pin.

(Note 4) For the bootstrap capacitor C_3 , take temperature characteristics, DC bias characteristics, etc. into consideration to set to the actual capacitance of no less than 0.047 μF .

1 V_{OUT} = 5.0 V – continued

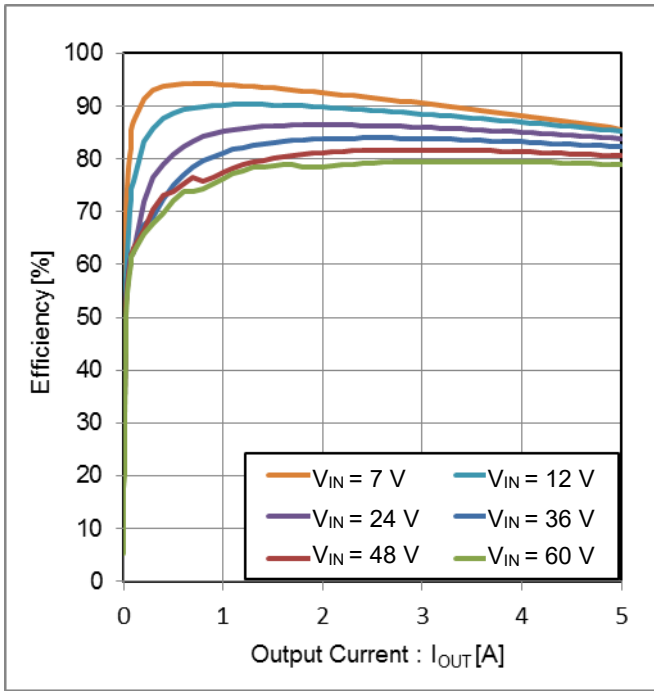

Figure 37. Efficiency vs Output Current

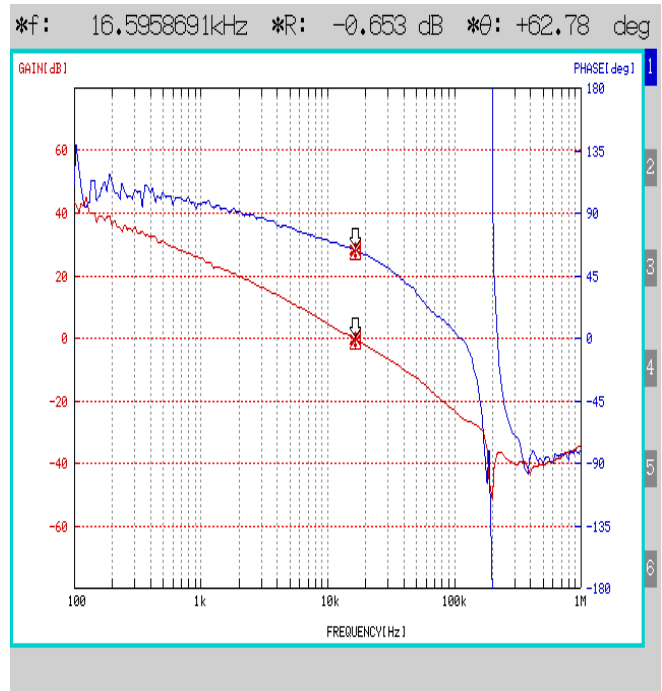

Figure 38. Frequency Characteristics
(I_{OUT} = 5.0 A)

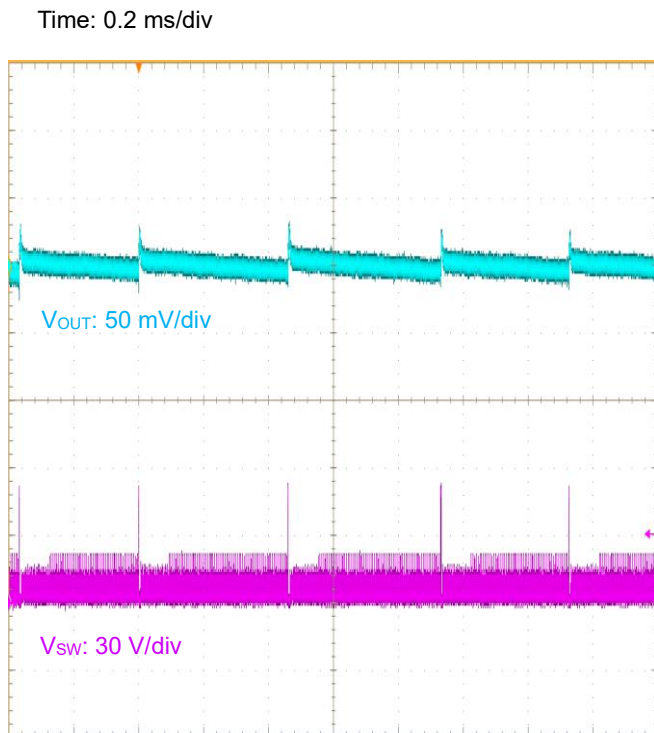

Figure 39. V_{OUT} Ripple
(I_{OUT} = 0 A)

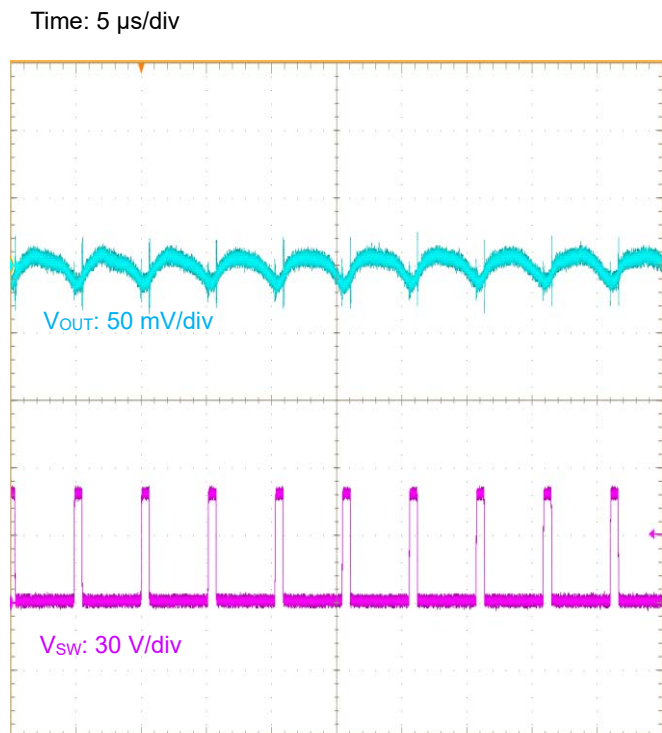

Figure 40. V_{OUT} Ripple
(I_{OUT} = 5.0 A)

1 $V_{OUT} = 5.0\text{ V}$ – continued

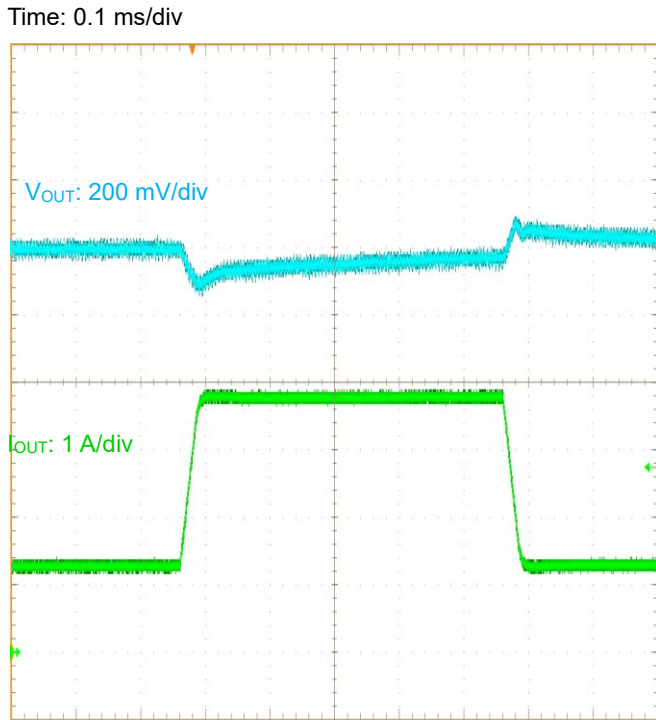

Figure 41. Load Transient Response
($I_{OUT} = 1.25\text{ A} - 3.75\text{ A}$)

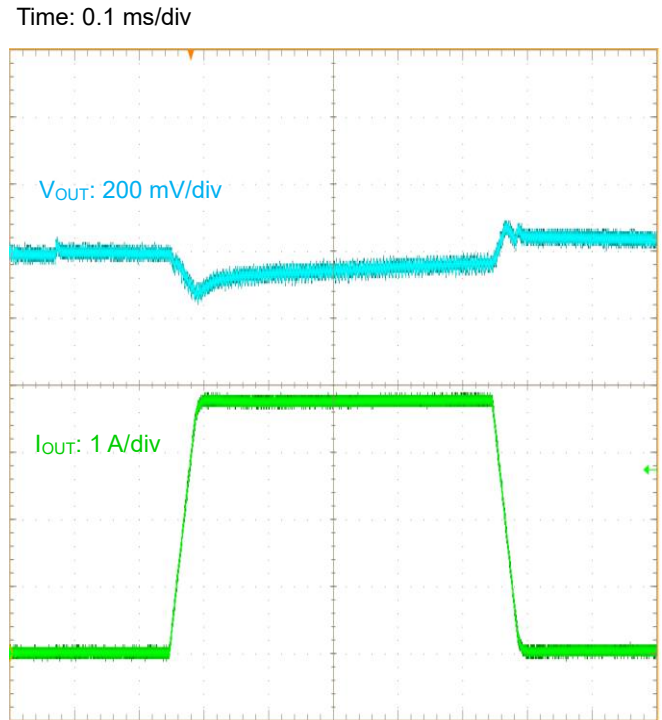

Figure 42. Load Transient Response
($I_{OUT} = 0\text{ A} - 3.75\text{ A}$)

Application Examples - continued

2 $V_{OUT} = 3.3\text{ V}$

Table 3. Specification of Application

Parameter	Symbol	Specification Value
Input Voltage	V_{IN}	7 V ~ 36 V
Output Voltage	V_{OUT}	3.3 V
Switching Frequency	f_{osc}	200 kHz (Typ)
Maximum Output Current	I_{OUTMAX}	5 A

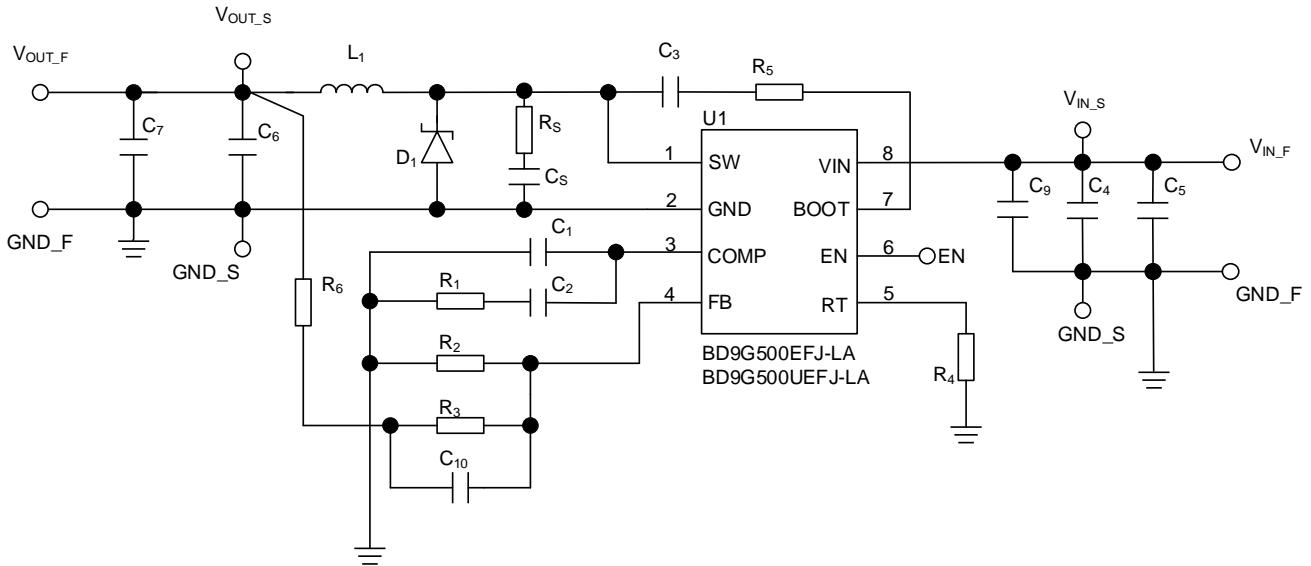

Figure 43. Application Circuit

Table 4. Recommended Component Values^(Note 1) ($V_{OUT} = 3.3\text{ V}$)

Part No.	Value	Part Name	Manufacturer
C_4 ^(Note 2)	15 μF / 100 V	KRM55WR72A156MH01L	MURATA
C_9 ^(Note 3)	1 μF / 100 V	GRM21BC72A105KE01L	MURATA
C_3 ^(Note 4)	1 μF / 10 V	GRM155C71A105KE11D	MURATA
C_2	6800 pF / 50 V	GRM1555C1H682JE01D	MURATA
C_6	47 μF / 25 V	KRM55WR71E476MH01L	MURATA
C_7	220 μF / 50 V Aluminum	UBT1H221M	NICHICON
R_1	43 k Ω	MCR03 series	ROHM
R_2	2.7 k Ω	MCR03 series	ROHM
R_3	6.2 k Ω	MCR03 series	ROHM
R_4	47 k Ω	MCR03 series	ROHM
R_5	0 Ω	MCR03 series	ROHM
R_6	10 Ω	MCR03 series	ROHM
D_1	100 V / 10 A	STPS15H100C	ST
		RB088BM100TL	ROHM
L_1	33 μH	7443551331	WURTH

(Note 1) These recommended component values for small output voltage ripple and improved transient response setting, please confirm on the actual equipment considering variations of the characteristics of the product and external components. Component not in table all for open conditions

(Note 2) For the capacitance of input capacitor, take temperature characteristics, DC bias characteristics, etc. into consideration to set to a minimum value of no less than 4.7 μF .

(Note 3) In order to reduce the influence of high frequency noise, connect a 1 μF ceramic capacitor as close as possible to the VIN pin and the GND pin.

(Note 4) For the bootstrap capacitor C_3 , take temperature characteristics, DC bias characteristics, etc. into consideration to set to the actual capacitance of no less than 0.047 μF .

2 $V_{OUT} = 3.3\text{ V}$ – continued

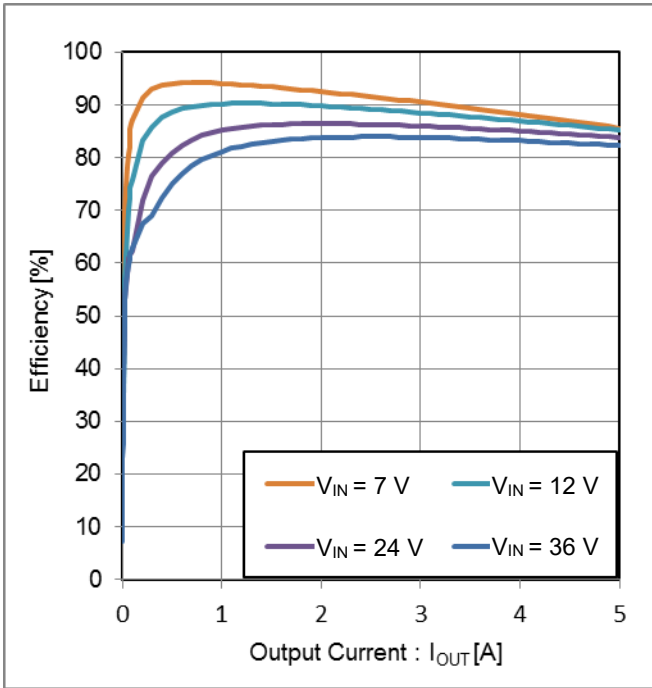

Figure 44. Efficiency vs Output Current

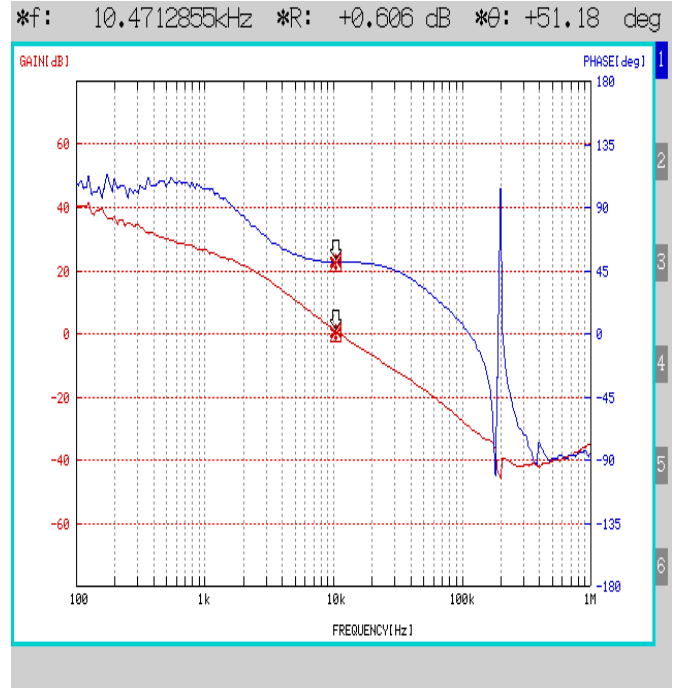

Figure 45. Frequency Characteristics $I_{OUT} = 5.0\text{ A}$

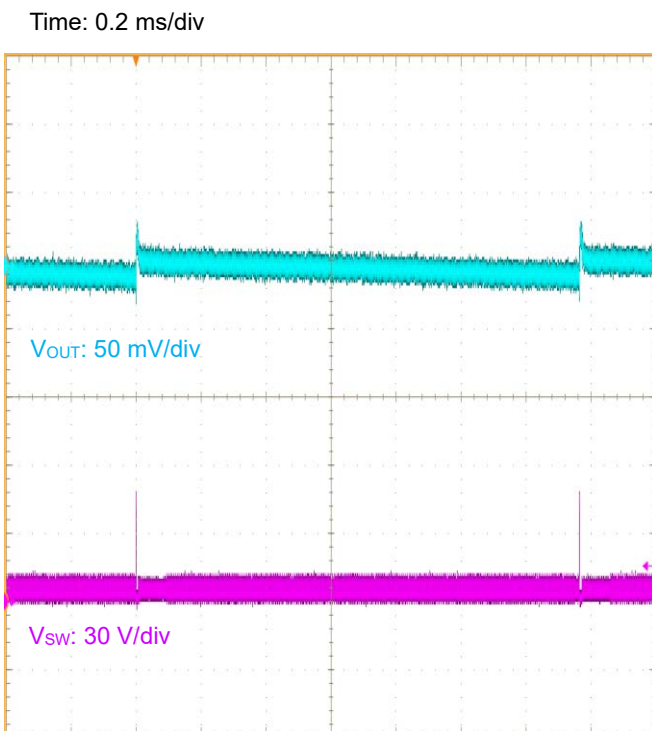

Figure 46. V_{OUT} Ripple
($I_{OUT} = 0\text{ A}$)

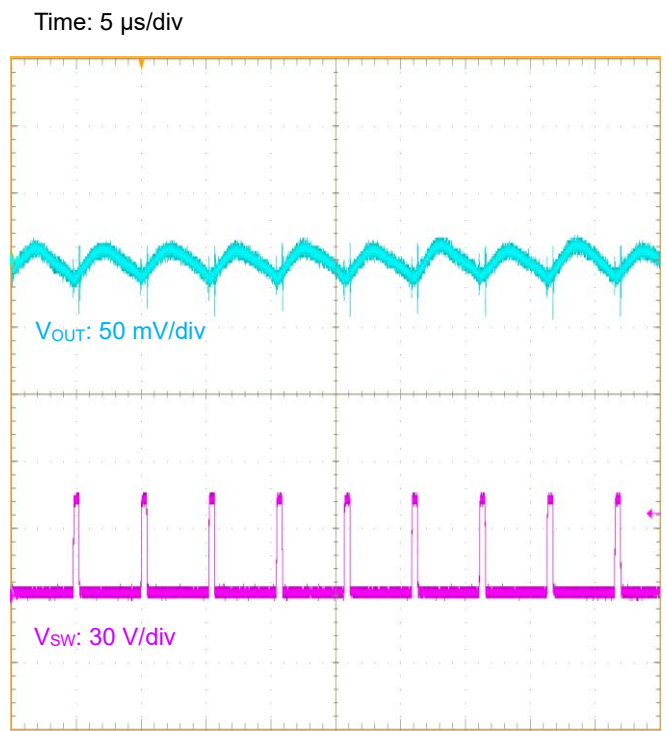

Figure 47. V_{OUT} Ripple
($I_{OUT} = 5.0\text{ A}$)

2 $V_{OUT} = 3.3\text{ V}$ – continued

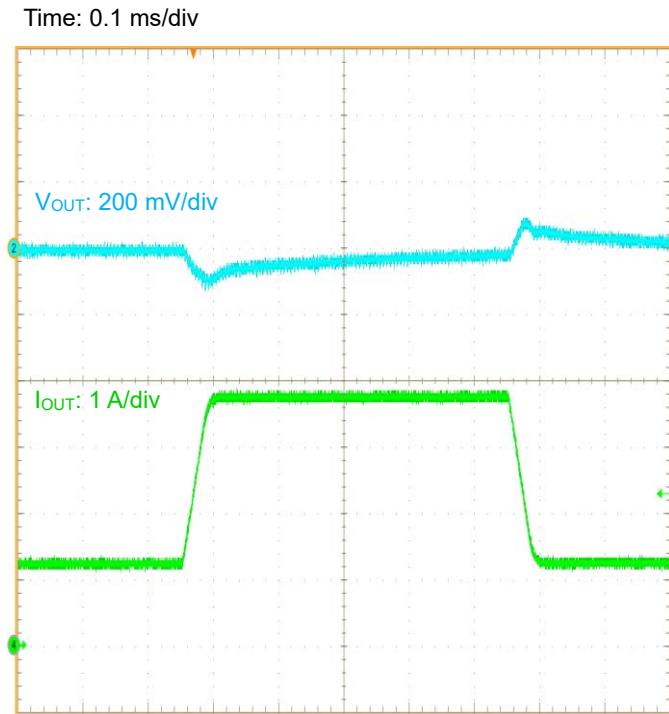

Figure 48. Load Transient Response
 ($V_{IN} = 36\text{ V}$, $I_{OUT} = 1.25\text{ A} - 3.75\text{ A}$)



Figure 49. Load Transient Response
 ($V_{IN} = 36\text{ V}$, $I_{OUT} = 0\text{ A} - 3.75\text{ A}$)

Application Examples - continued

3 $V_{OUT} = 12\text{ V}$

Table 5. Specification of Application

Parameter	Symbol	Specification Value
Input Voltage	V_{IN}	18 V ~ 60 V
Output Voltage	V_{OUT}	12 V
Switching Frequency	f_{osc}	200 kHz (Typ)
Maximum Output Current	I_{OUTMAX}	5 A

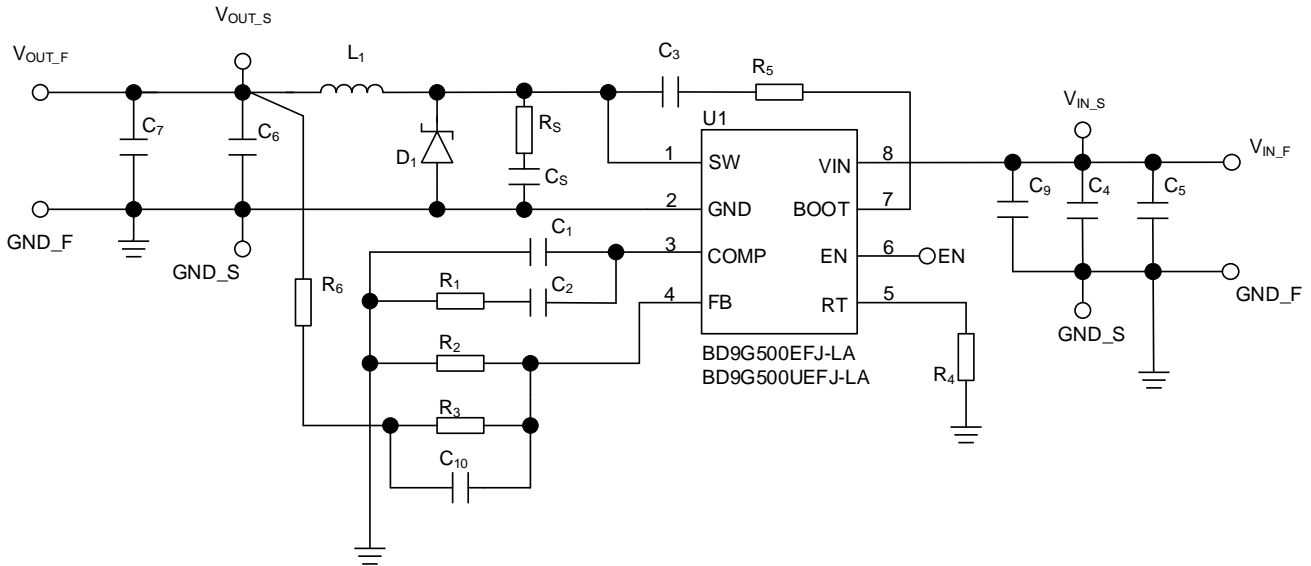

Figure 50. Application Circuit

Table 6. Recommended Component Values^(Note 1) ($V_{OUT} = 12\text{ V}$)

Part No.	Value	Part Name	Manufacturer
C_4 ^(Note 2)	15 μF / 100 V	KRM55WR72A156MH01L	MURATA
C_9 ^(Note 3)	1 μF / 100 V	GRM21BC72A105KE01L	MURATA
C_3 ^(Note 4)	1 μF / 10 V	GRM155C71A105KE11D	MURATA
C_2	6800 pF / 50 V	GRM1555C1H682JE01D	MURATA
C_6	47 μF / 25 V	KRM55WR7YA476MH01L	MURATA
C_7	220 μF / 50 V Aluminum	UBT1H221M	NICHICON
R_1	150 k Ω	MCR03 series	ROHM
R_2	0.3 k Ω	MCR03 series	ROHM
R_3	3.3 k Ω	MCR03 series	ROHM
R_4	47 k Ω	MCR03 series	ROHM
R_5	0 Ω	MCR03 series	ROHM
R_6	0 Ω	MCR03 series	ROHM
D_1	100 V / 10 A	STPS15H100C	ST
		RB088BM100TL	ROHM
L_1	33 μH	7443551331	WURTH

(Note 1) These recommended component values for small output voltage ripple and improved transient response setting, please confirm on the actual equipment considering variations of the characteristics of the product and external components. Component not in table all for open conditions

(Note 2) For the capacitance of input capacitor, take temperature characteristics, DC bias characteristics, etc. into consideration to set to a minimum value of no less than 4.7 μF .

(Note 3) In order to reduce the influence of high frequency noise, connect a 1 μF ceramic capacitor as close as possible to the VIN pin and the GND pin.

(Note 4) For the bootstrap capacitor C_3 , take temperature characteristics, DC bias characteristics, etc. into consideration to set to the actual capacitance of no less than 0.047 μF .

3 $V_{OUT} = 12\text{ V}$ – continued

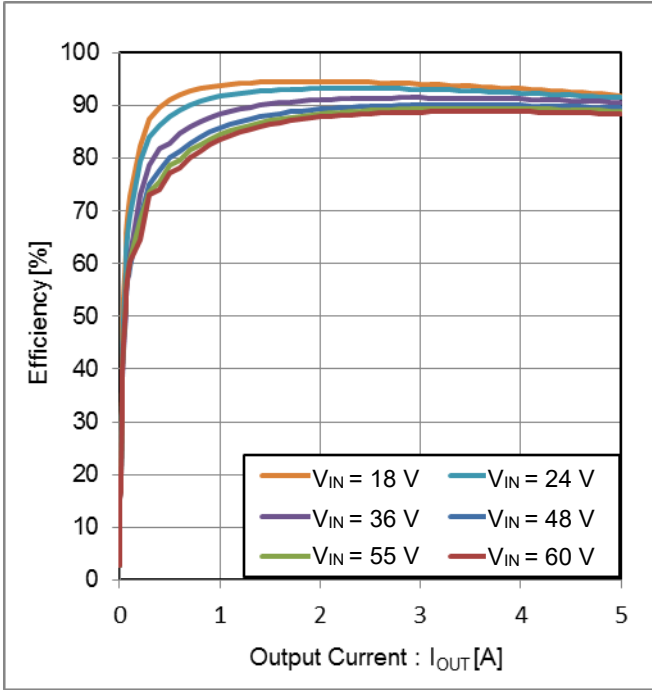

Figure 51. Efficiency vs Output Current

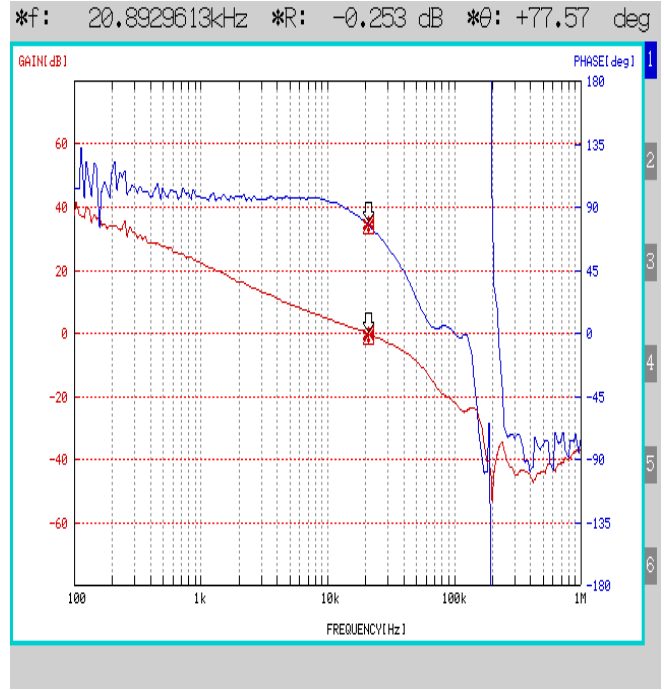

Figure 52. Frequency Characteristics ($I_{OUT} = 5.0\text{ A}$)

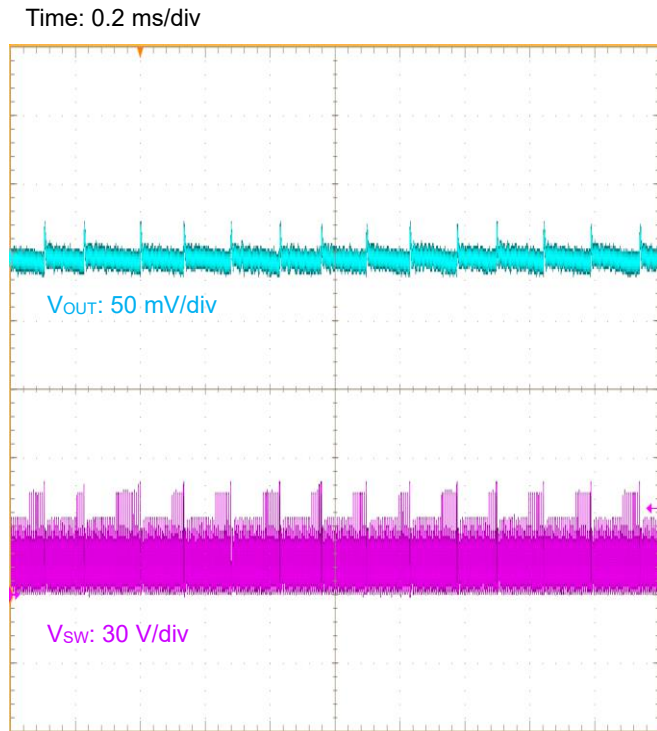

Figure 53. V_{OUT} Ripple ($I_{OUT} = 0\text{ A}$)

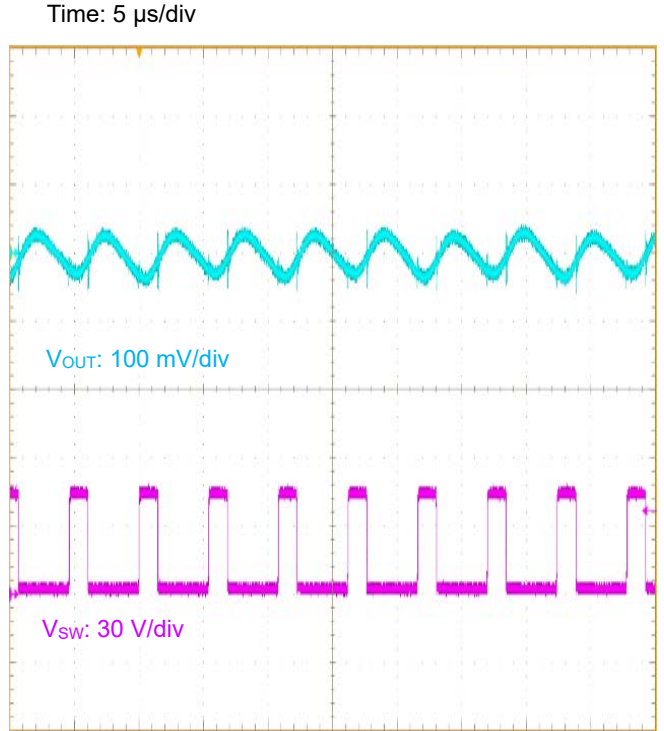

Figure 54. V_{OUT} Ripple ($I_{OUT} = 5.0\text{ A}$)

3 $V_{OUT} = 12\text{ V}$ – continued

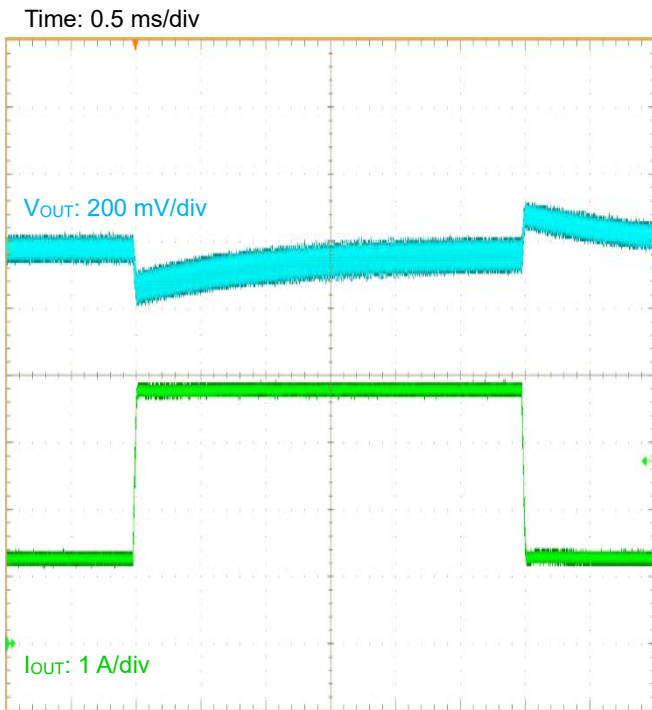

Figure 55. Load Transient Response
($I_{OUT} = 1.25\text{ A} - 3.75\text{ A}$)

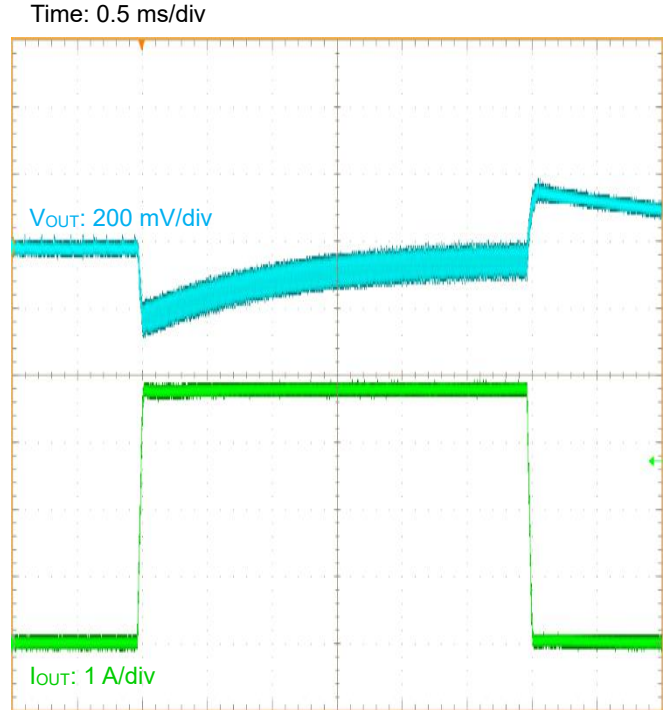

Figure 56. Load Transient Response
($I_{OUT} = 0\text{ A} - 3.75\text{ A}$)

Selection of Components Externally

Contact us if not use the recommended component values in Application Examples.

1. Switching Frequency

BD9G500EFJ-LA can setup arbitrary internal oscillator frequency by connecting RT resistance. Recommended frequency setting range is 100 kHz to 650 kHz, For setting frequency f_{OSC} [kHz], R_{RT} [kΩ], That can be used is calculated as follows. When R_{RT} (kΩ) = 47 kΩ the frequency closed to 200 kHz (Typ) operation.

$$R_{RT}(k\Omega) = \frac{18423}{f_{OSC}(kHz)^{1.127}}$$

$$f_{OSC}(kHz) = \frac{6093.5}{R_{RT}(k\Omega)^{0.887}}$$

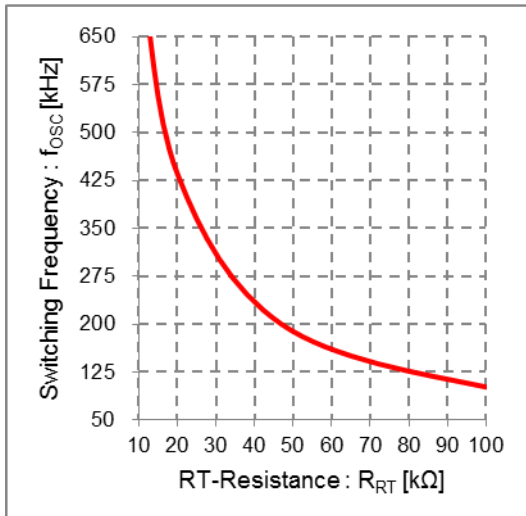

Figure 57. Switching Frequency vs RT-Resistance

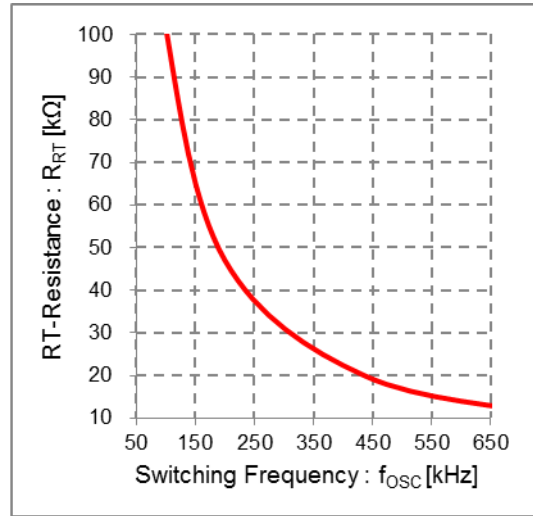

Figure 58. RT-Resistance vs Switching Frequency

2. Output LC Filter

The DC/DC converter requires an LC filter for smoothing the output voltage in order to supply a continuous current to the load. Selecting an inductor with a large inductance causes the ripple current ΔI_L that flows into the inductor to be small, decreasing the ripple voltage generated in the output voltage, but it is not advantageous in terms of the load transient response characteristic. Selecting an inductor with a small inductance improves the transient response characteristic but causes the inductor ripple current to be large, which increases the ripple voltage in the output voltage, showing a trade-off relationship.

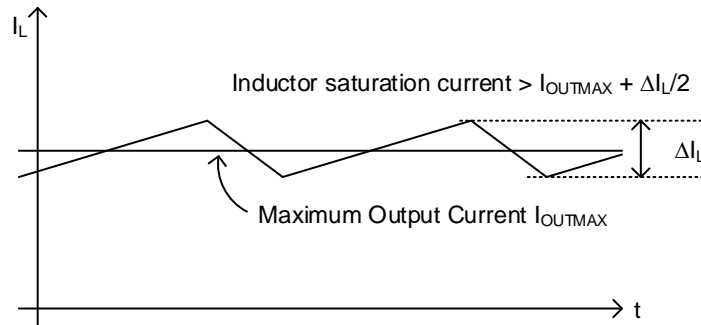

Figure 59. Waveform of Inductor Current

2. Output LC Filter – Connected

Computation ΔI_L . with $V_{IN} = 48$ V, $V_{OUT} = 5$ V, $L = 33$ μ H, and switching frequency $f_{OSC} = 200$ kHz, the method is as below.

$$\Delta I_L = V_{OUT} \times (V_{IN} - V_{OUT}) \times \frac{1}{V_{IN} \times f_{OSC} \times L} = 679 \text{ [mA]}$$

Also for saturation current of inductor, select the one with larger current than the total of maximum output current and 1/2 of inductor ripple current ΔI_L . Output capacitor C_{OUT} affects output ripple voltage characteristics. Select output capacitor C_{OUT} so that necessary ripple voltage characteristics are satisfied.

Output ripple voltage can be expressed in the following method.

$$\Delta V_{RPL} = \Delta I_L \times \left(R_{ESR} + \frac{1}{8 \times C_{OUT} \times f_{OSC}} \right) \text{ [V]}$$

R_{ESR} is the serial equivalent series resistance here.

With $C_{OUT} = 267$ μ F, $R_{ESR} = 30$ m Ω the output ripple voltage is calculated as below.

$$\Delta V_{RPL} = 0.679 \times \left(30\text{m}\Omega + \frac{1}{8 \times 267\mu \times 200\text{k}} \right) = 21.96 \text{ [mV]}$$

Be careful of total capacitance value, when additional capacitor C_{LOAD} is connected to output capacitor C_{OUT} . Use maximum additional capacitor C_{LOAD} (Max) condition which satisfies the following method. Maximum starting inductor ripple current I_{L_START} must smaller than over current limit 6.4 A (Min).

Maximum starting inductor ripple current I_{L_START} can be expressed in the following method.

$$I_{L_START} = I_{OUTMAX} + \left(\frac{\Delta I_L}{2} \right) + I_{CAP} \text{ [A]}$$

Charge current to output capacitor I_{CAP} can be expressed in the following method.

$$I_{CAP} = \frac{(C_{OUT} + C_{LOAD}) \times V_{OUT}}{t_{SS}} \text{ [A]}$$

Computation with $V_{IN} = 48$ V, $V_{OUT} = 5$ V, $L = 33$ μ H, $I_{OUTMAX} = 5$ A (Max), switching frequency $f_{OSC} = 180$ kHz (Min), Output capacitor $C_{OUT} = 267$ μ F, Soft Start Time $t_{SS} = 15$ ms (Min), the method is as below.

$$C_{LOAD}(Max) \leq \frac{\left(6.4 - I_{OUTMAX} - \frac{\Delta I_L}{2} \right) \times t_{SS}}{V_{OUT}} - C_{OUT} = 2801 \text{ [\mu F]}$$

3. Catch Diode

BD9G500EFJ-LA should be taken to connect external catch diode between the SW pin and the GND pin. The diode require adherence to absolute maximum ratings of application. Opposite direction voltage should be higher than maximum voltage of the VIN pin. Also for saturation current of diode, select the one with larger current than the total of maximum output current and 1/2 of inductor ripple current ΔI_L .

4. Bootstrap capacitor

Bootstrap capacitor C_3 shall be 1 μ F. Connect a bootstrap capacitor between the SW pin and the BOOT pin. For capacitance of Bootstrap capacitor, take temperature characteristics, DC bias characteristics, etc. into consideration to set minimum value to no less than 0.047 μ F.

Selection of Components Externally – Connected

5. Output Voltage Set Point

The output voltage value can be set by the feedback resistance ratio.

$$V_{OUT} = \frac{R_6 + R_2 + R_3}{R_2} [V]$$

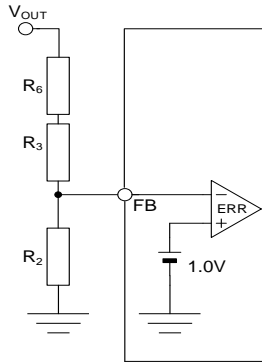

Figure 60. Feedback Resistor Circuit

6. Input capacitor configuration

For input capacitor, use a ceramic capacitor. For normal setting, 15 μF is recommended, but with larger value, input ripple voltage can be further reduced. Also, for capacitance of input capacitor, take temperature characteristics, DC bias characteristics, etc. into consideration to set minimum value to no less than 4.7 μF .

7. Phase Compensation

A current mode control buck DC/DC converter is a two-pole, one-zero system. Two-pole formed by an error amplifier and load and one zero point added by phase compensation. The phase compensation resistor R_1 determines the crossover frequency f_{CRS} where the total loop gain of the DC/DC converter is 0 dB. High value for this crossover frequency f_{CRS} provides a good load transient response characteristic but inferior stability. Conversely, specifying a low value for the crossover frequency f_{CRS} greatly stabilizes the characteristics but the load transient response characteristic is impaired.

7.1 Selection of Phase Compensation Resistor R_1

The phase compensation resistance R_1 can be determined by using the following equation.

$$R_1 = \frac{2 \times \pi \times V_{OUT} \times f_{CRS} \times C_{OUT}}{V_{FB} \times G_{MP} \times G_{MA}} [\Omega]$$

Where:

V_{OUT} is the output voltage

f_{CRS} is the crossover frequency

C_{OUT} is the output capacitance

V_{FB} is the feedback reference voltage (1.0 V (Typ))

G_{MP} is the current sense gain (14 A/V (Typ))

G_{MA} is the error amplifier transconductance (200 $\mu\text{A/V}$ (Typ))

7.2 Selection of phase compensation capacitance C_2

For stable operation of the DC/DC converter, inserting a zero point under 1/9 of the zero crossover frequency cancels the phase delay due to the pole formed by the load often provides favorable characteristics.

The phase compensation capacitance C_2 can be determined by using the following equation.

$$C_2 = \frac{1}{2 \times \pi \times R_1 \times f_Z} [F]$$

Where: f_Z is Zero point inserted

7.3 Loop stability

In order to secure stability of DC/DC converter, confirm there is enough phase margin on actual equipment.

Under the worst condition, it is recommended to secure phase margin more than 45°.

In practice, the characteristics may vary depending on PCB layout, routing of wiring, types of parts to use and operating environments (temperature, etc.).

Use gain-phase analyzer or FRA to confirm frequency characteristics on actual equipment. Contact the manufacturer of each measuring equipment to check its measuring method, etc.

PCB Layout Design

PCB layout design for DC/DC converter power supply IC is as important as the circuit design. Appropriate layout can avoid various problems caused by power supply circuit. Figure 66-a to 66-c show the current path in a buck DC/DC converter circuit. The Loop1 in Figure 66-a is a current path when High Side switch is ON, the Loop2 in Figure 66-b is when High Side switch is OFF. The thick line in Figure 66-c shows the difference between Loop1 and Loop2. The current in thick line changes sharply each time the switching element change from OFF to ON, and vice versa. These sharp changes induce several harmonics in the waveform. Therefore, the loop area of thick line that is consisted by input capacitor and IC should be as small as possible to minimize noise. For more detail, refer to application note of switching regulator series “PCB Layout Techniques of Buck Converter”.

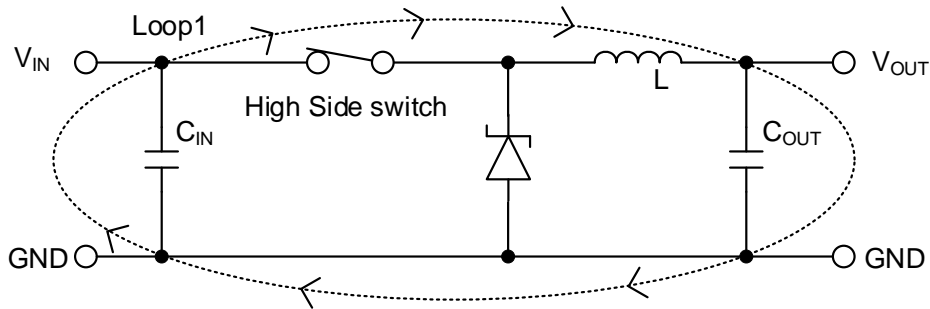

Figure 61-a. Current path when High Side switch = ON

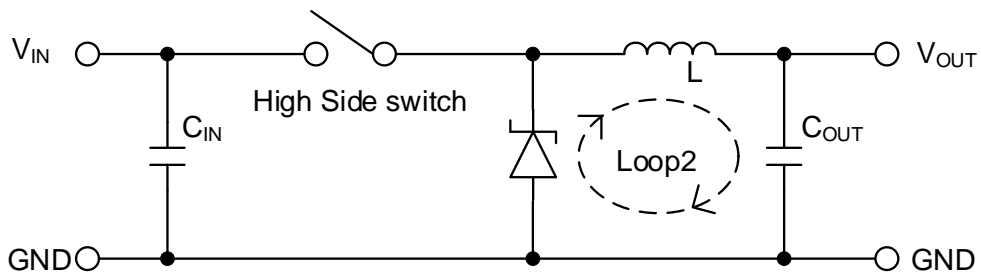

Figure 61-b. Current Path when High Side switch = OFF

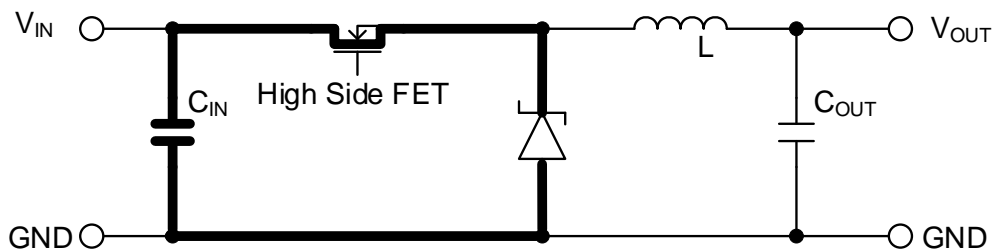
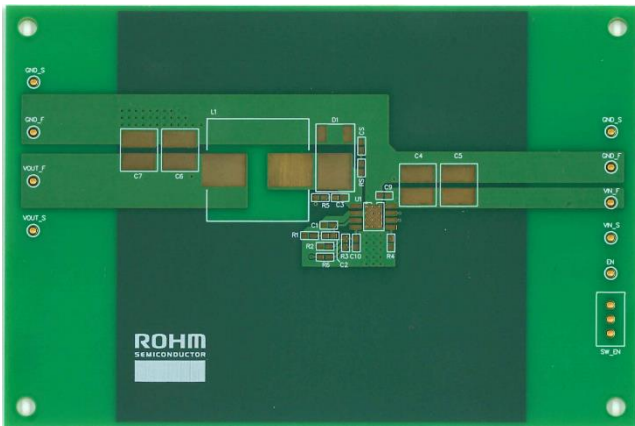

Figure 61-c. Difference of Current and Critical Area in Layout

PCB Layout Design - continued

Accordingly, design the PCB layout with particular attention paid to the following points.

- Provide the input capacitor close to the VIN pin of the IC as possible on the same plane as the IC.
- If there is any unused area on the PCB, provide a copper foil plane for the ground node to assist heat dissipation from the IC and the surrounding components.
- Switching nodes such as SW are susceptible to noise due to AC coupling with other nodes. Trace to the coil and catch diode as thick and short as possible.
- Provide lines connected to the FB pin and the COMP pin as far from the SW node.
- Provide the output capacitor away from the input capacitor in order to avoid the effect of harmonic noise from the input.



Top Layer

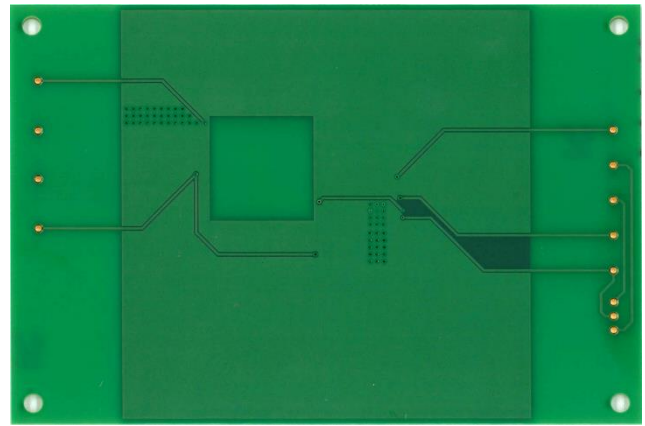

Bottom Layer

Figure 62. Example of Sample Board Layout Pattern

I/O Equivalence Circuit

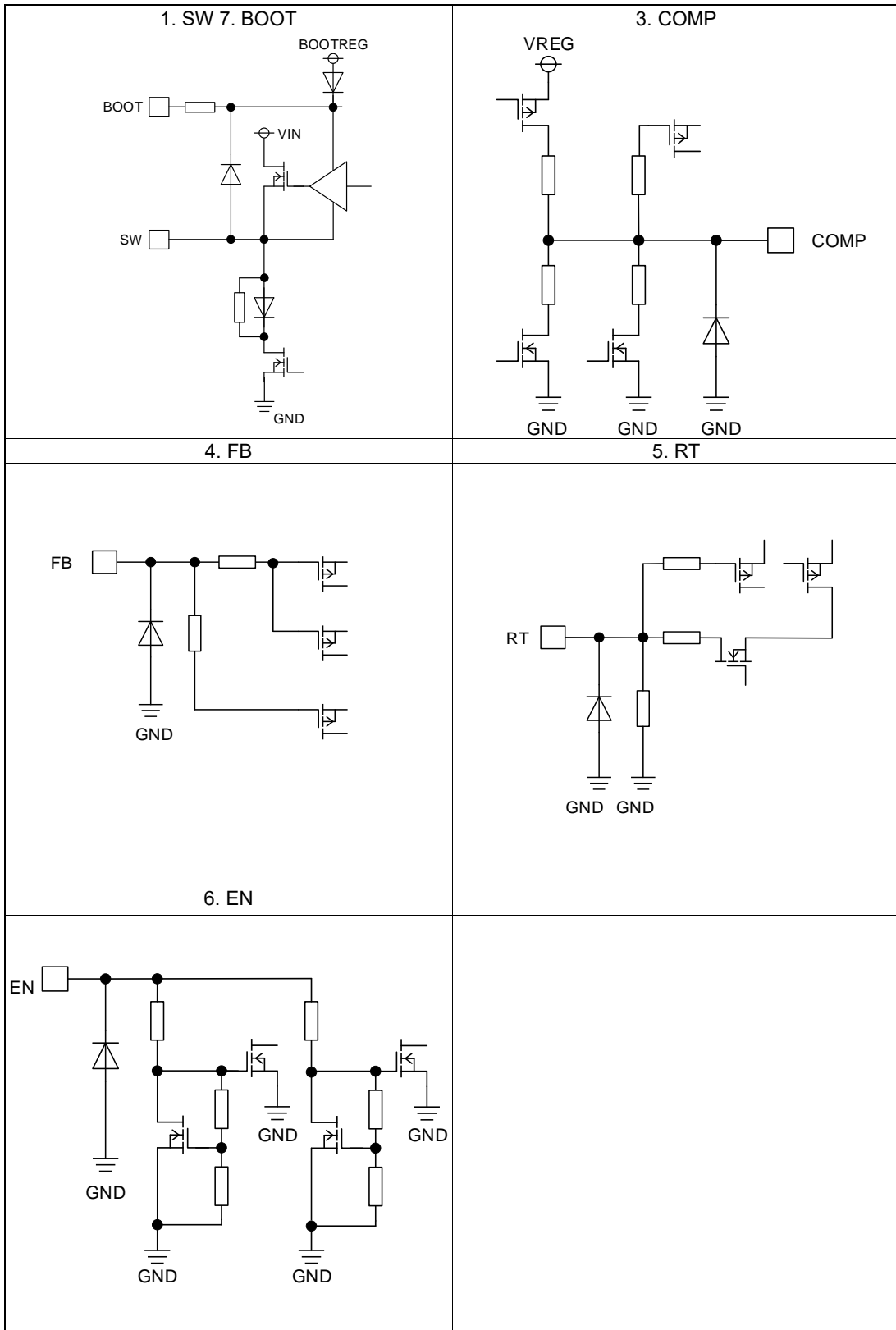

Operational Notes

1. Reverse Connection of Power Supply

Connecting the power supply in reverse polarity can damage the IC. Take precautions against reverse polarity when connecting the power supply, such as mounting an external diode between the power supply and the IC's power supply pins.

2. Power Supply Lines

Design the PCB layout pattern to provide low impedance supply lines. Furthermore, connect a capacitor to ground at all power supply pins. Consider the effect of temperature and aging on the capacitance value when using electrolytic capacitors.

3. Ground Voltage

Ensure that no pins are at a voltage below that of the ground pin at any time, even during transient condition. However, pins that drive inductive loads (e.g. motor driver outputs, DC-DC converter outputs) may inevitably go below ground due to back EMF or electromotive force. In such cases, the user should make sure that such voltages going below ground will not cause the IC and the system to malfunction by examining carefully all relevant factors and conditions such as motor characteristics, supply voltage, operating frequency and PCB wiring to name a few.

4. Ground Wiring Pattern

When using both small-signal and large-current ground traces, the two ground traces should be routed separately but connected to a single ground at the reference point of the application board to avoid fluctuations in the small-signal ground caused by large currents. Also ensure that the ground traces of external components do not cause variations on the ground voltage. The ground lines must be as short and thick as possible to reduce line impedance.

5. Recommended Operating Conditions

The function and operation of the IC are guaranteed within the range specified by the recommended operating conditions. The characteristic values are guaranteed only under the conditions of each item specified by the electrical characteristics.

6. Inrush Current

When power is first supplied to the IC, it is possible that the internal logic may be unstable and inrush current may flow instantaneously due to the internal powering sequence and delays, especially if the IC has more than one power supply. Therefore, give special consideration to power coupling capacitance, power wiring, width of ground wiring, and routing of connections.

7. Testing on Application Boards

When testing the IC on an application board, connecting a capacitor directly to a low-impedance output pin may subject the IC to stress. Always discharge capacitors completely after each process or step. The IC's power supply should always be turned off completely before connecting or removing it from the test setup during the inspection process. To prevent damage from static discharge, ground the IC during assembly and use similar precautions during transport and storage.

8. Inter-pin Short and Mounting Errors

Ensure that the direction and position are correct when mounting the IC on the PCB. Incorrect mounting may result in damaging the IC. Avoid nearby pins being shorted to each other especially to ground, power supply and output pin. Inter-pin shorts could be due to many reasons such as metal particles, water droplets (in very humid environment) and unintentional solder bridge deposited in between pins during assembly to name a few.

9. Unused Input Pins

Input pins of an IC are often connected to the gate of a MOS transistor. The gate has extremely high impedance and extremely low capacitance. If left unconnected, the electric field from the outside can easily charge it. The small charge acquired in this way is enough to produce a significant effect on the conduction through the transistor and cause unexpected operation of the IC. So unless otherwise specified, unused input pins should be connected to the power supply or ground line.

Operational Notes – continued

10. Regarding the Input Pin of the IC

This monolithic IC contains P+ isolation and P substrate layers between adjacent elements in order to keep them isolated. P-N junctions are formed at the intersection of the P layers with the N layers of other elements, creating a parasitic diode or transistor. For example (refer to figure below):

When $GND > Pin A$ and $GND > Pin B$, the P-N junction operates as a parasitic diode.

When $GND > Pin B$, the P-N junction operates as a parasitic transistor.

Parasitic diodes inevitably occur in the structure of the IC. The operation of parasitic diodes can result in mutual interference among circuits, operational faults, or physical damage. Therefore, conditions that cause these diodes to operate, such as applying a voltage lower than the GND voltage to an input pin (and thus to the P substrate) should be avoided.

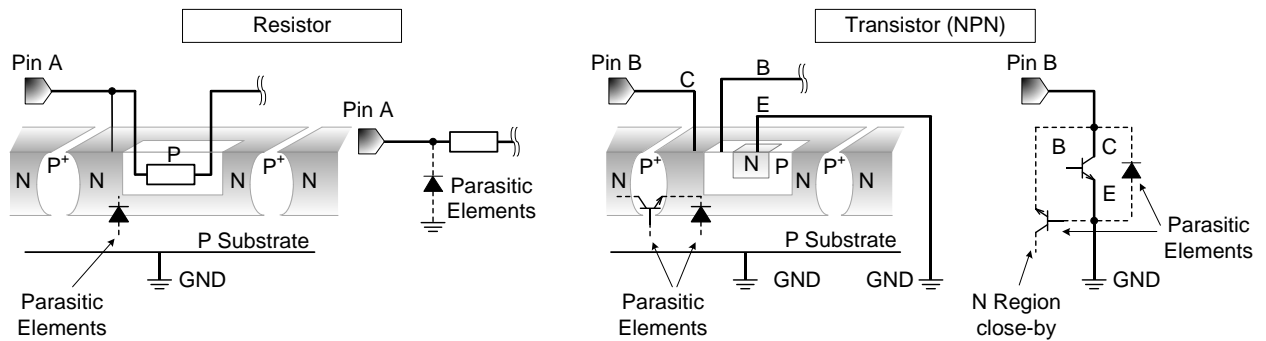

Figure 63. Example of Monolithic IC Structure

11. Ceramic Capacitor

When using a ceramic capacitor, determine a capacitance value considering the change of capacitance with temperature and the decrease in nominal capacitance due to DC bias and others.

12. Thermal Shutdown Circuit (TSD)

This IC has a built-in thermal shutdown circuit that prevents heat damage to the IC. Normal operation should always be within the IC's maximum junction temperature rating. If however the rating is exceeded for a continued period, the junction temperature (T_j) will rise which will activate the TSD circuit that will turn OFF power output pins. When the T_j falls below the TSD threshold, the circuits are automatically restored to normal operation.

Note that the TSD circuit operates in a situation that exceeds the absolute maximum ratings and therefore, under no circumstances, should the TSD circuit be used in a set design or for any purpose other than protecting the IC from heat damage.

13. Over Current Protection Circuit (OCP)

This IC incorporates an integrated overcurrent protection circuit that is activated when the load is shorted. This protection circuit is effective in preventing damage due to sudden and unexpected incidents. However, the IC should not be used in applications characterized by continuous operation or transitioning of the protection circuit.

Ordering Information

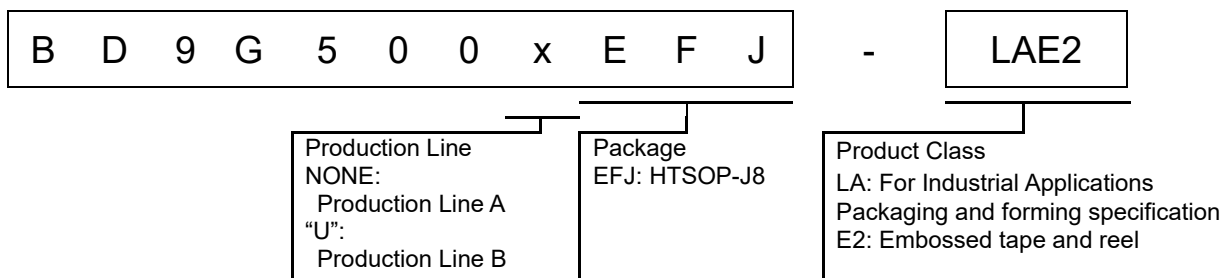

Package	Part Number	Remarks
HTSOP-J8	BD9G500EFJ-LAE2	Production Line A ^(Note 1)
HTSOP-J8	BD9G500UEFJ-LAE2	Production Line B ^(Note 1)

(Note 1) For the purpose of improving production efficiency, Production Line A and B have a multi-line configuration. Electrical characteristics noted in Datasheet does not differ between Production Line A and B. Production Line B is recommended for new product.

Marking Diagram

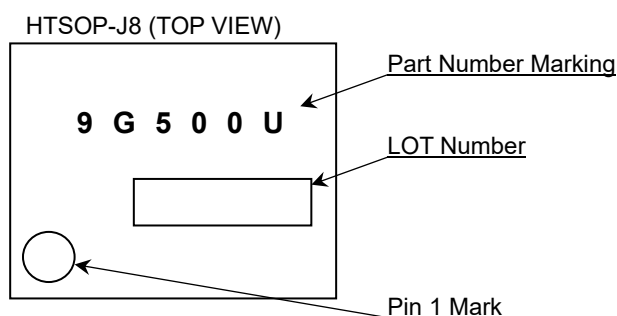
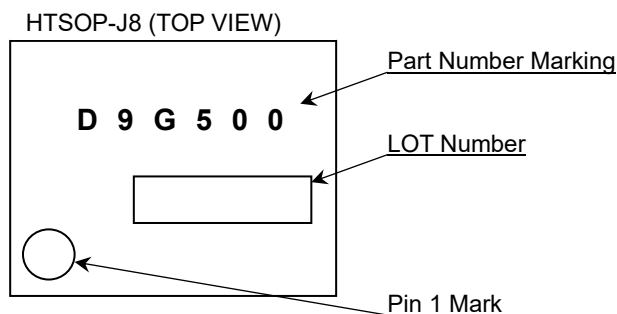

Physical Dimension and Packing Information

Package Name	HTSOP-J8
--------------	----------

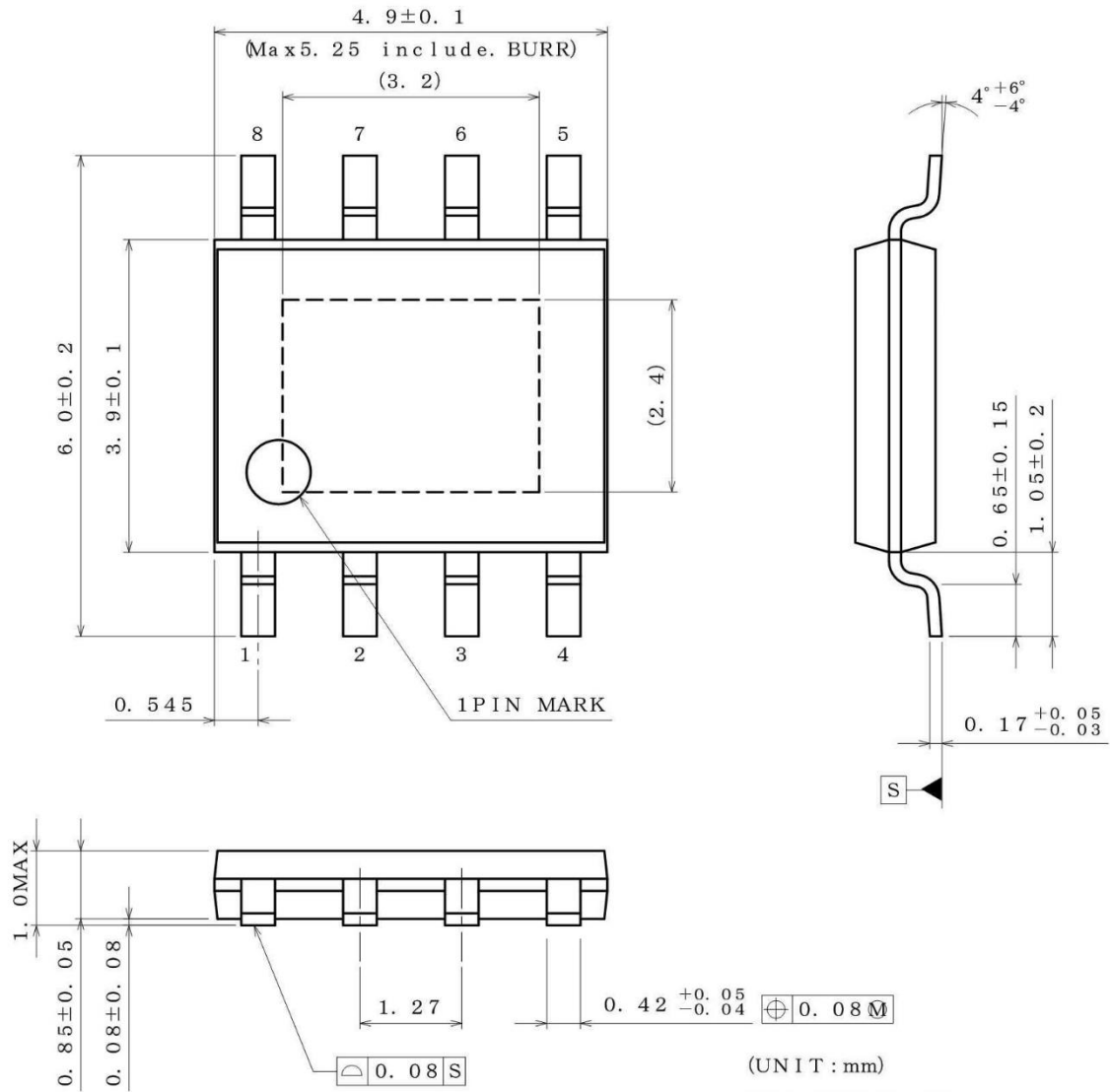

(UNIT : mm)

PKG : HTSOP-J8

Drawing No. EX169-5002-2

< Tape and Reel Information >

Tape	Embossed carrier tape
Quantity	2500pcs
Direction of feed	E2 The direction is the pin 1 of product is at the upper left when you hold reel on the left hand and you pull out the tape on the right hand

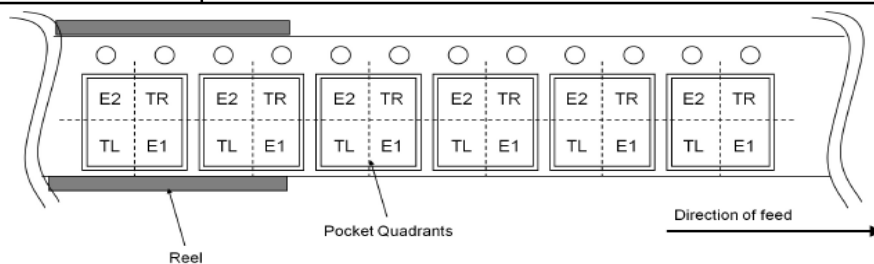

Revision History

Date	Revision	Changes
11.Jun.2020	001	New Release
20.May.2022	002	Add BD9G500UEFJ-LA

Notice

Precaution on using ROHM Products

1. If you intend to use our Products in devices requiring extremely high reliability (such as medical equipment ^(Note 1), aircraft/spacecraft, nuclear power controllers, etc.) and whose malfunction or failure may cause loss of human life, bodily injury or serious damage to property ("Specific Applications"), please consult with the ROHM sales representative in advance. Unless otherwise agreed in writing by ROHM in advance, ROHM shall not be in any way responsible or liable for any damages, expenses or losses incurred by you or third parties arising from the use of any ROHM's Products for Specific Applications.

(Note1) Medical Equipment Classification of the Specific Applications

JAPAN	USA	EU	CHINA
CLASS III	CLASS III	CLASS II b	CLASS III
CLASS IV		CLASS III	

2. ROHM designs and manufactures its Products subject to strict quality control system. However, semiconductor products can fail or malfunction at a certain rate. Please be sure to implement, at your own responsibilities, adequate safety measures including but not limited to fail-safe design against the physical injury, damage to any property, which a failure or malfunction of our Products may cause. The following are examples of safety measures:
 - [a] Installation of protection circuits or other protective devices to improve system safety
 - [b] Installation of redundant circuits to reduce the impact of single or multiple circuit failure
3. Our Products are not designed under any special or extraordinary environments or conditions, as exemplified below. Accordingly, ROHM shall not be in any way responsible or liable for any damages, expenses or losses arising from the use of any ROHM's Products under any special or extraordinary environments or conditions. If you intend to use our Products under any special or extraordinary environments or conditions (as exemplified below), your independent verification and confirmation of product performance, reliability, etc. prior to use, must be necessary:
 - [a] Use of our Products in any types of liquid, including water, oils, chemicals, and organic solvents
 - [b] Use of our Products outdoors or in places where the Products are exposed to direct sunlight or dust
 - [c] Use of our Products in places where the Products are exposed to sea wind or corrosive gases, including Cl₂, H₂S, NH₃, SO₂, and NO₂
 - [d] Use of our Products in places where the Products are exposed to static electricity or electromagnetic waves
 - [e] Use of our Products in proximity to heat-producing components, plastic cords, or other flammable items
 - [f] Sealing or coating our Products with resin or other coating materials
 - [g] Use of our Products without cleaning residue of flux (Exclude cases where no-clean type fluxes is used. However, recommend sufficiently about the residue.); or Washing our Products by using water or water-soluble cleaning agents for cleaning residue after soldering
 - [h] Use of the Products in places subject to dew condensation
4. The Products are not subject to radiation-proof design.
5. Please verify and confirm characteristics of the final or mounted products in using the Products.
6. In particular, if a transient load (a large amount of load applied in a short period of time, such as pulse, is applied, confirmation of performance characteristics after on-board mounting is strongly recommended. Avoid applying power exceeding normal rated power; exceeding the power rating under steady-state loading condition may negatively affect product performance and reliability.
7. De-rate Power Dissipation depending on ambient temperature. When used in sealed area, confirm that it is the use in the range that does not exceed the maximum junction temperature.
8. Confirm that operation temperature is within the specified range described in the product specification.
9. ROHM shall not be in any way responsible or liable for failure induced under deviant condition from what is defined in this document.

Precaution for Mounting / Circuit board design

1. When a highly active halogenous (chlorine, bromine, etc.) flux is used, the residue of flux may negatively affect product performance and reliability.
2. In principle, the reflow soldering method must be used on a surface-mount products, the flow soldering method must be used on a through hole mount products. If the flow soldering method is preferred on a surface-mount products, please consult with the ROHM representative in advance.

For details, please refer to ROHM Mounting specification

Precautions Regarding Application Examples and External Circuits

1. If change is made to the constant of an external circuit, please allow a sufficient margin considering variations of the characteristics of the Products and external components, including transient characteristics, as well as static characteristics.
2. You agree that application notes, reference designs, and associated data and information contained in this document are presented only as guidance for Products use. Therefore, in case you use such information, you are solely responsible for it and you must exercise your own independent verification and judgment in the use of such information contained in this document. ROHM shall not be in any way responsible or liable for any damages, expenses or losses incurred by you or third parties arising from the use of such information.

Precaution for Electrostatic

This Product is electrostatic sensitive product, which may be damaged due to electrostatic discharge. Please take proper caution in your manufacturing process and storage so that voltage exceeding the Products maximum rating will not be applied to Products. Please take special care under dry condition (e.g. Grounding of human body / equipment / solder iron, isolation from charged objects, setting of Ionizer, friction prevention and temperature / humidity control).

Precaution for Storage / Transportation

1. Product performance and soldered connections may deteriorate if the Products are stored in the places where:
 - [a] the Products are exposed to sea winds or corrosive gases, including Cl₂, H₂S, NH₃, SO₂, and NO₂
 - [b] the temperature or humidity exceeds those recommended by ROHM
 - [c] the Products are exposed to direct sunshine or condensation
 - [d] the Products are exposed to high Electrostatic
2. Even under ROHM recommended storage condition, solderability of products out of recommended storage time period may be degraded. It is strongly recommended to confirm solderability before using Products of which storage time is exceeding the recommended storage time period.
3. Store / transport cartons in the correct direction, which is indicated on a carton with a symbol. Otherwise bent leads may occur due to excessive stress applied when dropping of a carton.
4. Use Products within the specified time after opening a humidity barrier bag. Baking is required before using Products of which storage time is exceeding the recommended storage time period.

Precaution for Product Label

A two-dimensional barcode printed on ROHM Products label is for ROHM's internal use only.

Precaution for Disposition

When disposing Products please dispose them properly using an authorized industry waste company.

Precaution for Foreign Exchange and Foreign Trade act

Since concerned goods might be fallen under listed items of export control prescribed by Foreign exchange and Foreign trade act, please consult with ROHM in case of export.

Precaution Regarding Intellectual Property Rights

1. All information and data including but not limited to application example contained in this document is for reference only. ROHM does not warrant that foregoing information or data will not infringe any intellectual property rights or any other rights of any third party regarding such information or data.
2. ROHM shall not have any obligations where the claims, actions or demands arising from the combination of the Products with other articles such as components, circuits, systems or external equipment (including software).
3. No license, expressly or implied, is granted hereby under any intellectual property rights or other rights of ROHM or any third parties with respect to the Products or the information contained in this document. Provided, however, that ROHM will not assert its intellectual property rights or other rights against you or your customers to the extent necessary to manufacture or sell products containing the Products, subject to the terms and conditions herein.

Other Precaution

1. This document may not be reprinted or reproduced, in whole or in part, without prior written consent of ROHM.
2. The Products may not be disassembled, converted, modified, reproduced or otherwise changed without prior written consent of ROHM.
3. In no event shall you use in any way whatsoever the Products and the related technical information contained in the Products or this document for any military purposes, including but not limited to, the development of mass-destruction weapons.
4. The proper names of companies or products described in this document are trademarks or registered trademarks of ROHM, its affiliated companies or third parties.

General Precaution

1. Before you use our Products, you are requested to carefully read this document and fully understand its contents. ROHM shall not be in any way responsible or liable for failure, malfunction or accident arising from the use of any ROHM's Products against warning, caution or note contained in this document.
2. All information contained in this document is current as of the issuing date and subject to change without any prior notice. Before purchasing or using ROHM's Products, please confirm the latest information with a ROHM sales representative.
3. The information contained in this document is provided on an "as is" basis and ROHM does not warrant that all information contained in this document is accurate and/or error-free. ROHM shall not be in any way responsible or liable for any damages, expenses or losses incurred by you or third parties resulting from inaccuracy or errors of or concerning such information.