

8.0V to 35V, 3.0A/1.5A 1ch Buck Converter with Integrated FET

BD9873CP-V5 BD9874CP-V5

General Description

The BD9873CP-V5 and BD9874CP-V5 is a single-channel step-down switching regulator integrated with a P-Channel MOSFET. Its circuitry eliminates the need for external compensation and consisting only of a diode, a coil and a ceramic capacitor, reducing the board size significantly.

Features

- Built-in P-Channel FET Ensures High Efficiency
- Output Voltage Adjustable Via External Resistors
- Soft-Start Time : 4ms (fixed)
- Built-in Over-Current and Thermal Shutdown Protection Circuits
- ON/OFF Control Via STBY Pin

Applications

TVs, Printers, DVD Players, Projectors, Gaming Devices, PCs, Car Audio/Navigation Systems, ETCs, Communication Equipment, AV Products, Office Equipment, Industrial Devices, and more.

Key Specifications

- Input Voltage Range: 8.0V to 35V
- Output Voltage Range: 1.0V to $0.8V \times (V_{CC} - I_{OUT} \times R_{ON}) / V$
- Output Current:
 - BD9873CP-V5: 1.5A(Max)
 - BD9874CP-V5: 3.0A(Max)
- Switching Frequency: 110kHz(Typ)
- P-Channel FET ON-Resistance:
 - BD9873CP-V5: 1.0Ω(Typ)
 - BD9874CP-V5: 0.5Ω(Typ)
- Standby Current: 1μA(Typ)
- Operating Temperature Range: -40°C to +85°C

Package

W(Typ) x D(Typ) x H(Max)



Typical Application Circuit

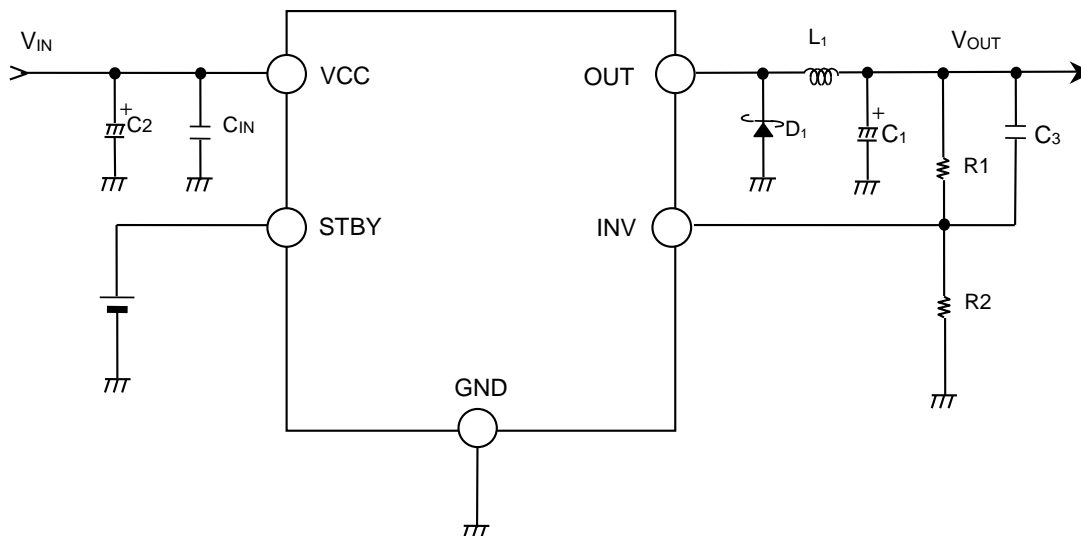

Figure 1. Typical Application Circuit

Pin Configuration

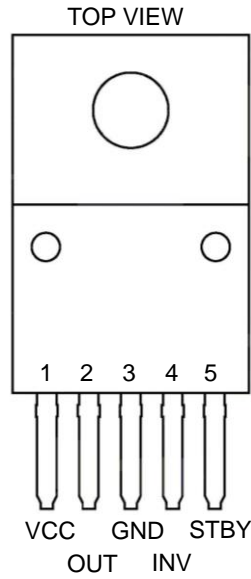

Figure 2. Pin Configuration

Pin Descriptions

Pin No.	Pin Name	Function
1	VCC	Input power supply pin
2	OUT	Internal P-Channel FET drain pin
3	GND	Ground
4	INV	Output voltage feedback pin
5	STBY	ON/OFF control pin

Block Diagram

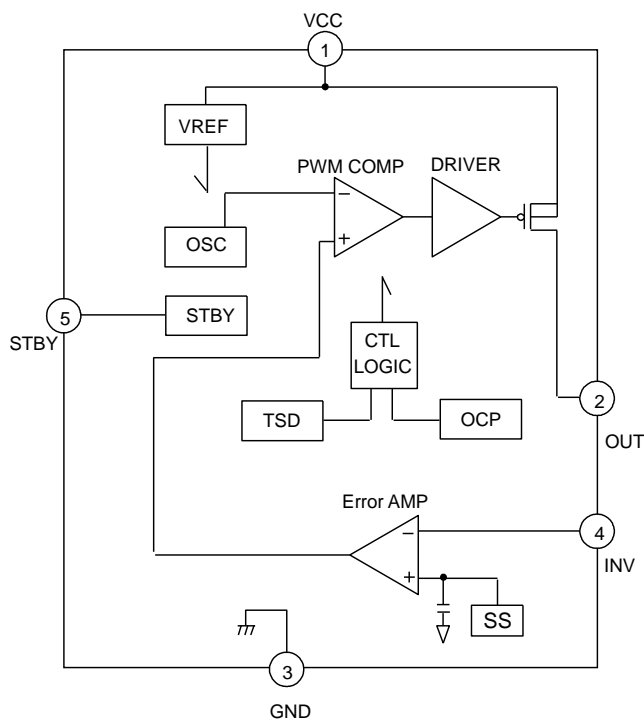

Figure 3. Block Diagram

Absolute Maximum Ratings (Ta=25°C)

Parameter	Symbol	Rating	Unit
Supply Voltage (VCC-GND)	V _{CC}	36	V
STBY-GND	V _{STBY}	36	V
OUT-GND	V _{OUT}	36	V
INV-GND	V _{INV}	5	V
Maximum Switching Current	I _{OUT}	1.5 (Note 1) BD9873	A
		3.0 (Note 1) BD9874	A
Power Dissipation	P _d	2.00 (Note 2)	W
Operating Temperature	T _{opr}	-40 to +85	°C
Storage Temperature	T _{stg}	-55 to +150	°C

(Note 1) Do not exceed Pd, ASO.

(Note 2) Derated at 0.16W/°C over Ta=25°C

Caution: Operating the IC over the absolute maximum ratings may damage the IC. The damage can either be a short circuit between pins or an open circuit between pins and internal circuitry. Therefore, it is important to consider circuit protection measures, such as adding a fuse, in case the IC is operated over the absolute maximum ratings.

Recommended Operating Conditions (Ta=-40°C to +85°C)

Parameter	Symbol	Limit			Unit
		Min	Typ	Max	
Input Voltage	V _{CC}	8.0	-	35.0	V
Output Voltage	V _{OUT}	1.0	-	0.8 x (V _{CC} -I _{OUT} x R _{ON})	V

Electrical Characteristics (Unless otherwise noted, Ta=25°C, V_{CC}=12V, V_{OUT}=5V, V_{STBY}=3V)

Parameter	Symbol	Limit			Unit	Conditions	
		Min	Typ	Max			
Output ON-Resistance	R _{ON}	-	1.0	1.5	Ω	BD9873	
		-	0.5	1.0	Ω	BD9874	
Efficiency	η	80	88	-	%	I _{OUT} = 0.5A	
Switching Frequency	f _{osc}	99	110	121	kHz		
Load Regulation	ΔV _{OUTLOAD}	-	5	40	mV	V _{CC} =20V, I _{OUT} =0.5A to 1.5A BD9873	
		-	5	40	mV	V _{CC} =20V, I _{OUT} =1.0A to 3.0A BD9874	
Line Regulation	ΔV _{OUTLOAD}	-	5	25	mV	V _{CC} =10V to 30V, I _{OUT} =1.0A	
Over-Current Protection Limit	I _{OCP}	1.6	-	-	A	BD9873	
		3.2	-	-	A	BD9874	
INV Pin Threshold Voltage	V _{INV}	0.985	1.00	1.015	V		
INV Pin Input Current	I _{INV}	-	1	2	μA	V _{INV} =1.0V	
STBY Pin Threshold Voltage	ON	V _{STBYON}	2.0	-	V _{CC}	V	
	OFF	V _{STBYOFF}	-0.3	-	+0.3	V	
STBY Pin Input Current	I _{STBY}	5	15	30	μA	V _{STBY} =3V	
Circuit Current	I _{CC}	-	5	12	mA	V _{INV} =2V	
Stand-by Current	I _{ST}	-	0	5	μA	V _{STBY} =0V	
Soft-Start Time	t _{SS}	-	4	20	ms	V _{STBY} =0V to 3V	

Typical Performance Curves
BD9873CP-V5

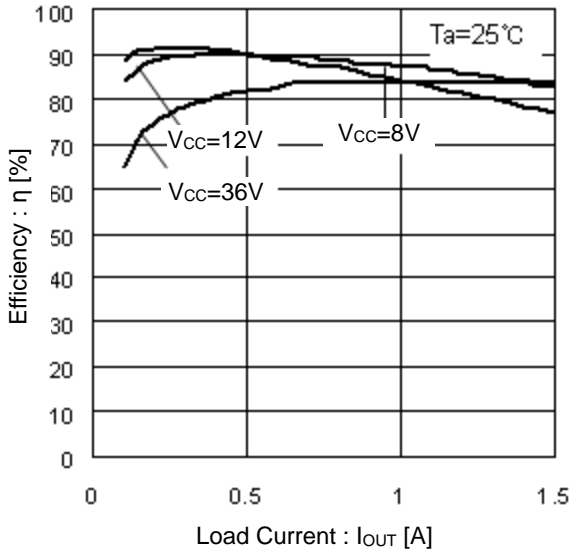

Figure 4. Efficiency vs Load Current

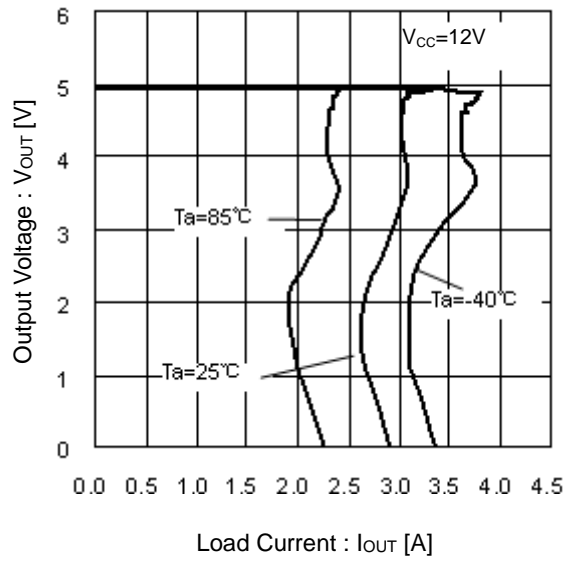

Figure 5 Output Voltage vs Load Current.
(Over Current Protection)

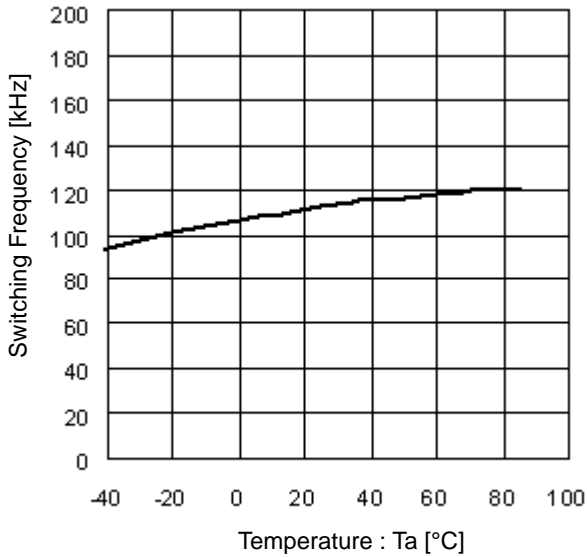

Figure 6. Switching Frequency vs Temperature

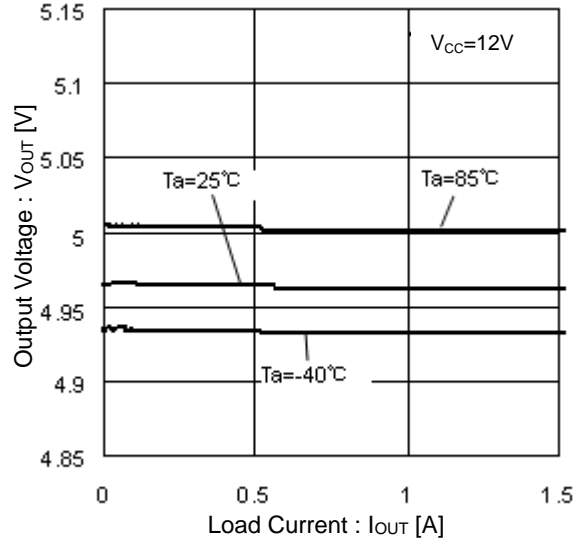

Figure 7. Output Voltage vs Load Current

Typical Performance Curves – continued
BD9873CP-V5

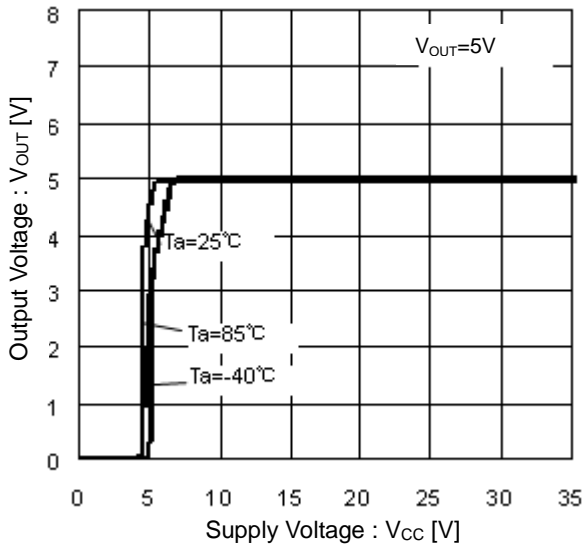

Figure 8. Output Voltage vs Supply Voltage

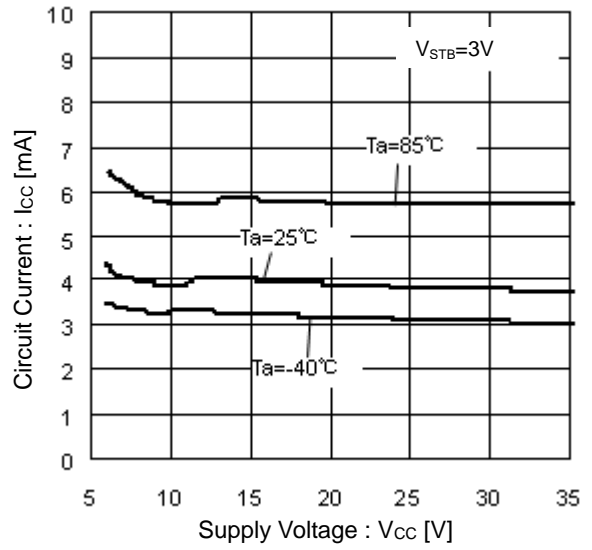

Figure 9. Circuit Current vs Supply Voltage
(I_{OUT}=No Load)

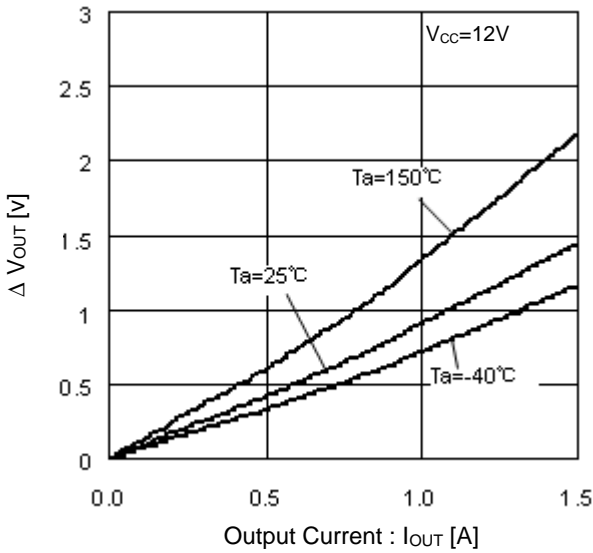

Figure 10. Delta Output Voltage vs Output Current
 $\Delta V_{OUT} - I_{OUT}$

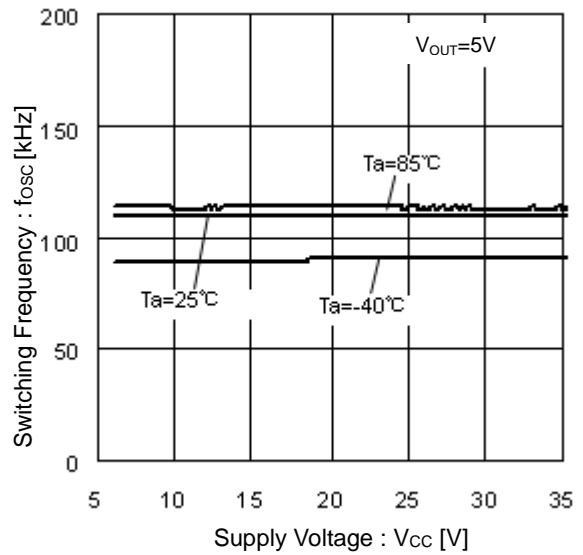

Figure 11. Switching Frequency vs Supply Voltage

Typical Performance Curves – continued
BD9873CP-V5

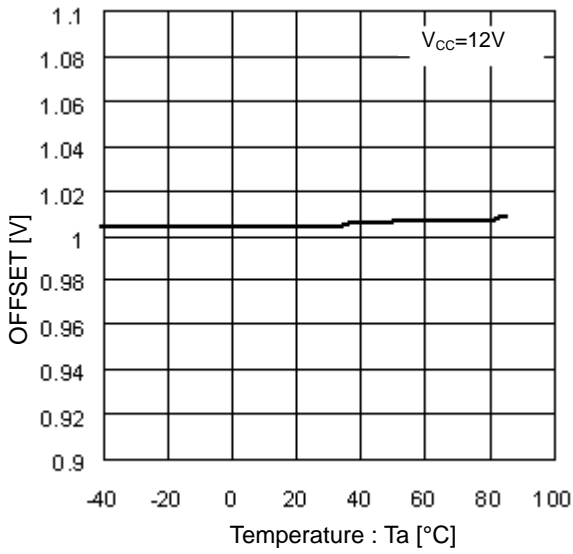

Figure 12. INV Pin Threshold Voltage vs Temperature

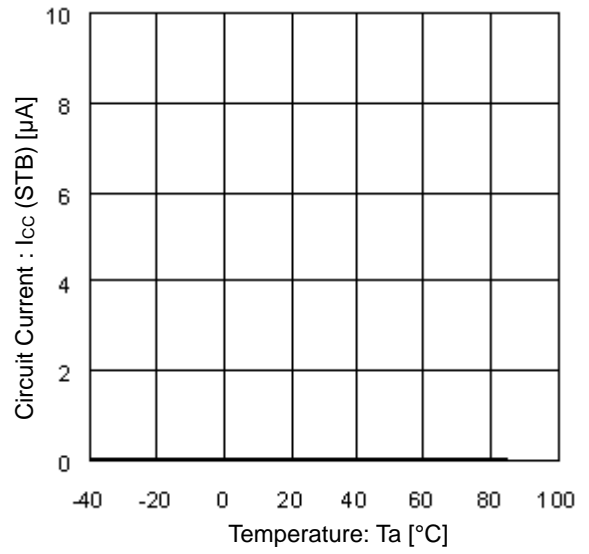

Figure 13. Circuit Current vs Temperature
I_{CC} (STB) - Ta

Typical Waveforms
BD9873CP-V5

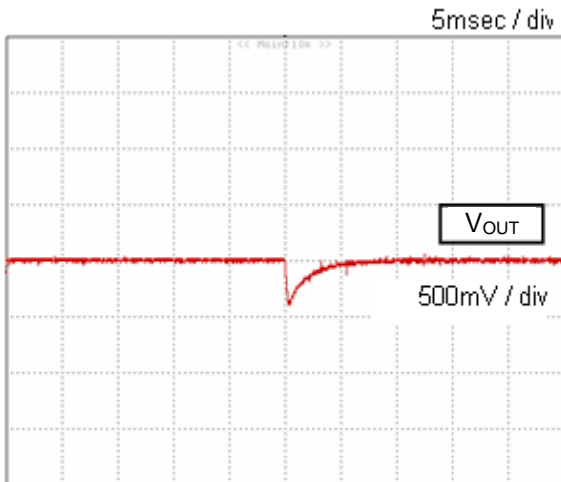

Figure 14. Load Response

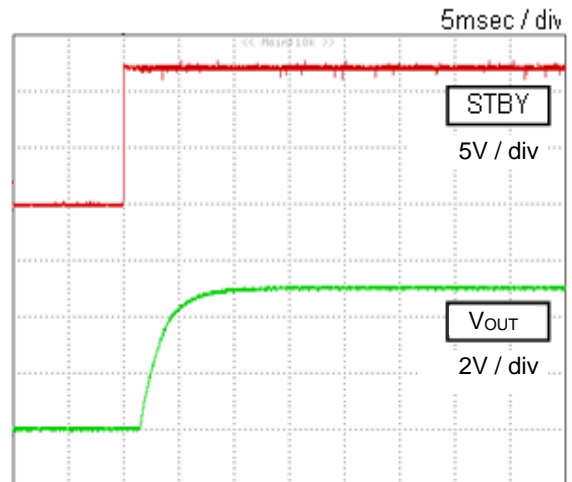

Figure 15. Start-up Waveform

Typical Performance Curves
BD9874CP-V5

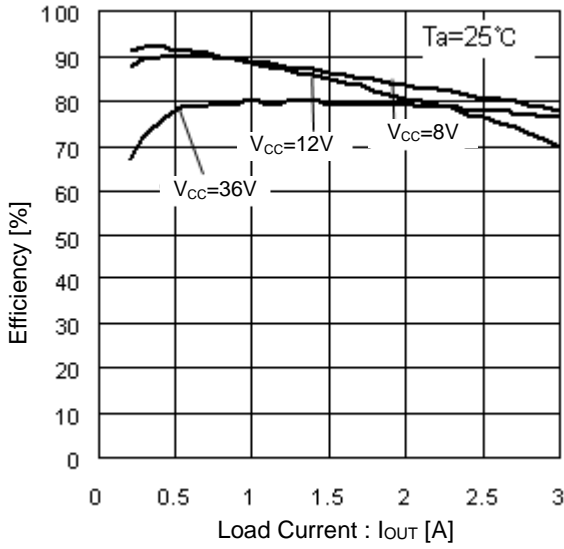

Figure 16. Efficiency vs Load Current

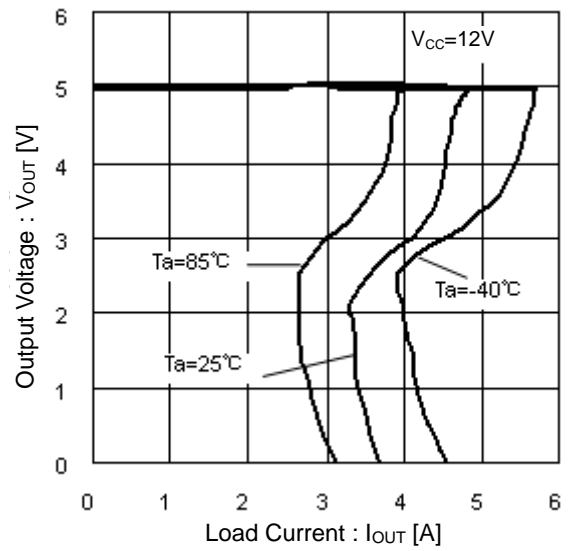

Figure 17. Output Voltage vs Load Current (Over Current Protection)

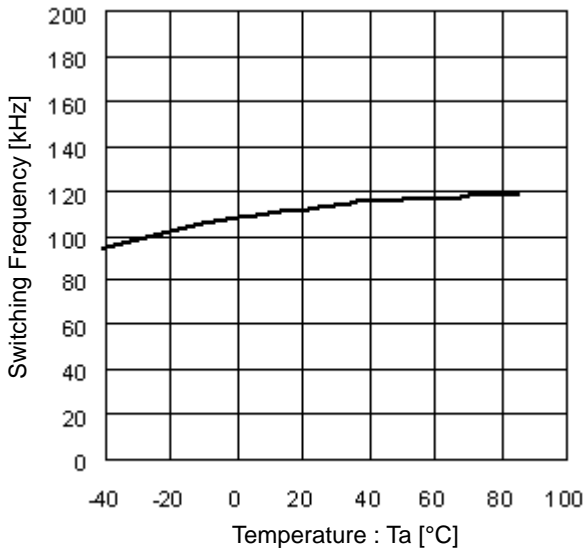

Figure 18. Switching Frequency vs Temperature

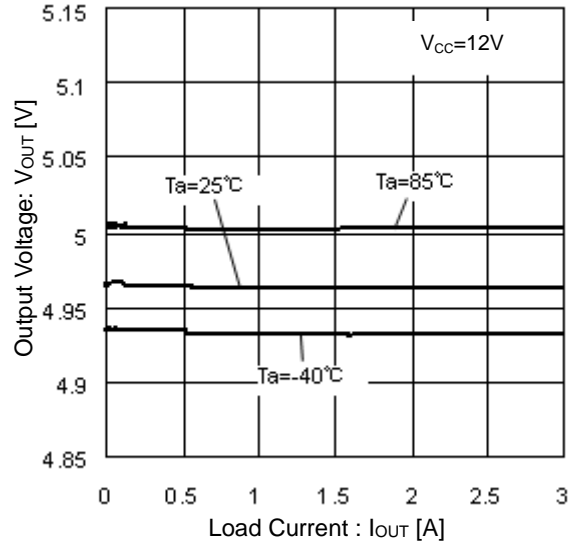

Figure 19. Output Voltage vs Load Current

Typical Performance Curves – continued
BD9874CP-V5

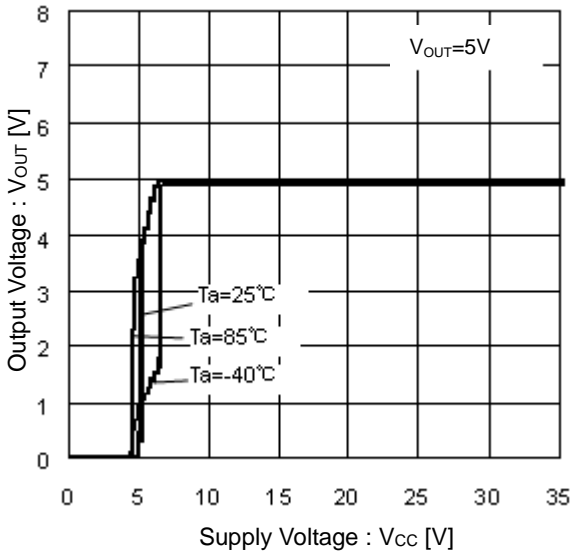

Figure 20. Output Voltage vs Supply Voltage

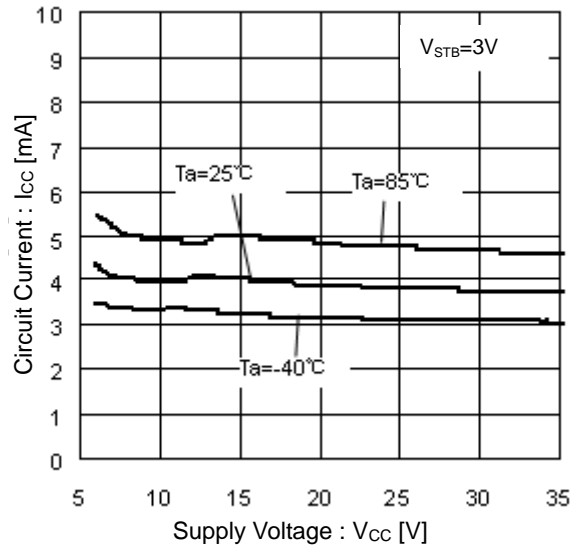

Figure 21. Circuit Current vs Supply Voltage
(I_{OUT}=No Load)

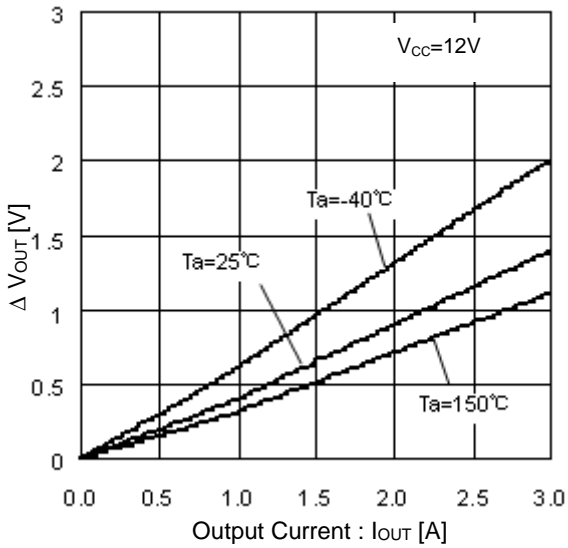

Figure 22. Delta Output Voltage vs Output Current
 $\Delta V_{OUT} - I_{OUT}$

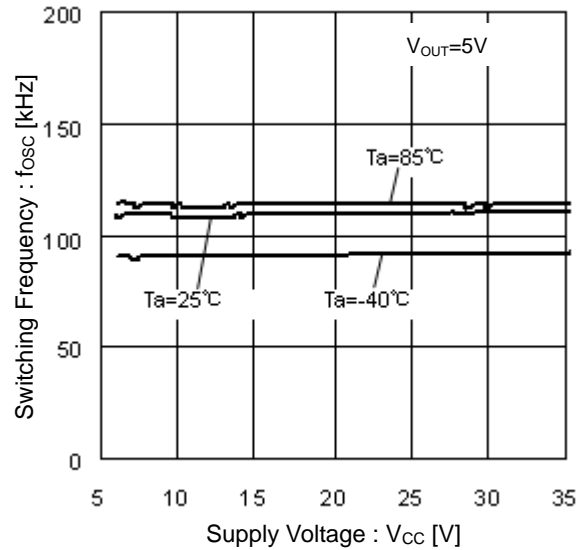

Figure 23. Switching Frequency vs Supply Voltage

Typical Performance Curves – continued
BD9874CP-V5

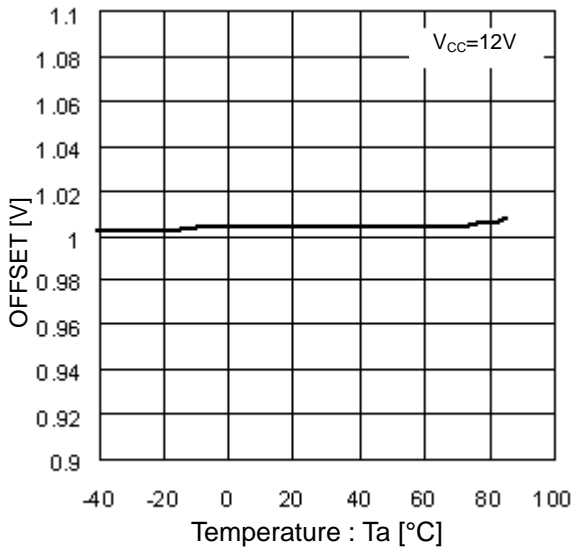

Figure 24. INV Pin Threshold Voltage vs Temperature

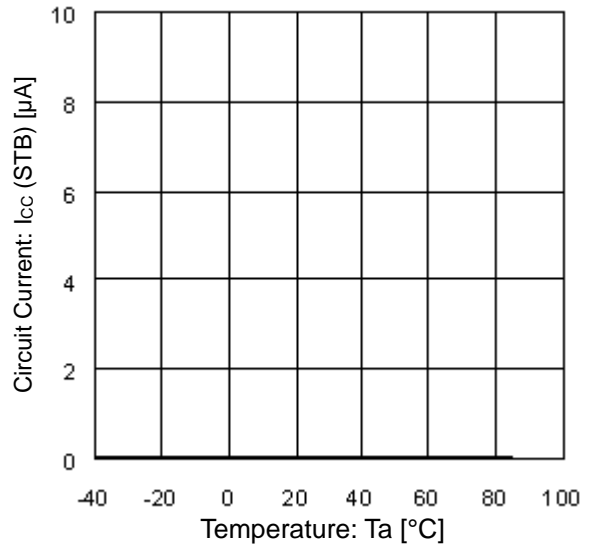

Figure 25. Circuit Current vs Temperature (Icc (STB) – Ta)

Typical Waveforms
BD9874CP-V5

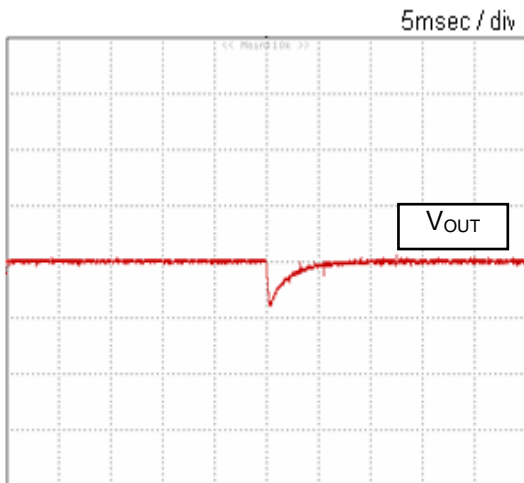

Figure 26. Load Response

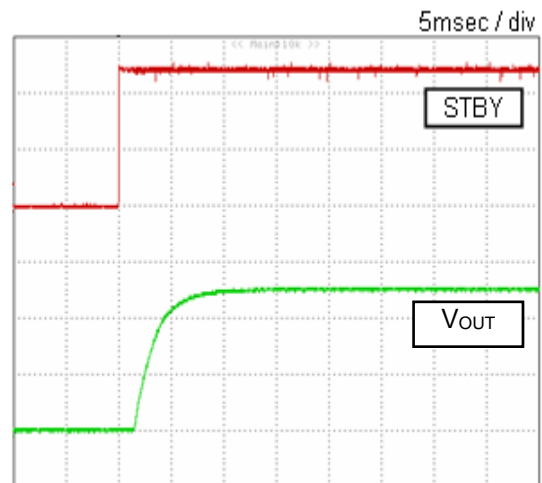

Figure 27. Start-up Waveform

Application Information

1. Block Function Explanation

(1) VREF

Generates a temperature-independent regulated voltage from the VCC input.

(2) OSC

Generates a triangular wave with an oscillation frequency of 110 kHz or as set by the internal resistors and capacitors. The output of this block goes to the PWM comparator.

(3) Error AMP

Detects the output voltage through a voltage divider network and compares it with an internal reference voltage. The output of this block is the amplified difference between the detected output voltage and the reference.

(4) PWM COMP

Converts the Error AMP output to PWM pulses going to the Driver block.

(5) DRIVER

This push-pull FET driver accepts PWM input pulses from PWM COMP block and drives the internal P-channel MOSFET.

(6) STBY

Controls ON/OFF operation using STBY pin. The output is ON when STBY is High.

(7) Thermal Shutdown (TSD)

This circuit protects the IC against thermal runaway and damage due to excessive heat. A thermal sensor detects the junction temperature and switches the output OFF once the temperature exceeds a threshold value (175deg). Hysteresis is built in (15deg) in order to prevent malfunctions due to temperature fluctuations.

(8) Over-Current Protection (OCP)

The OCP circuit detects the voltage difference between VCC and OUT by measuring the current through the internal P-Channel MOSFET and switches the output OFF once the voltage reaches the threshold value. The OCP block is a self-recovery type (not latch).

(9) Soft-Start (SS)

This block conducts soft start operations. When STBY is High and the IC starts up the internal capacitor begins charging. The soft start time is set to 5ms.

2. Notes for PCB Layout

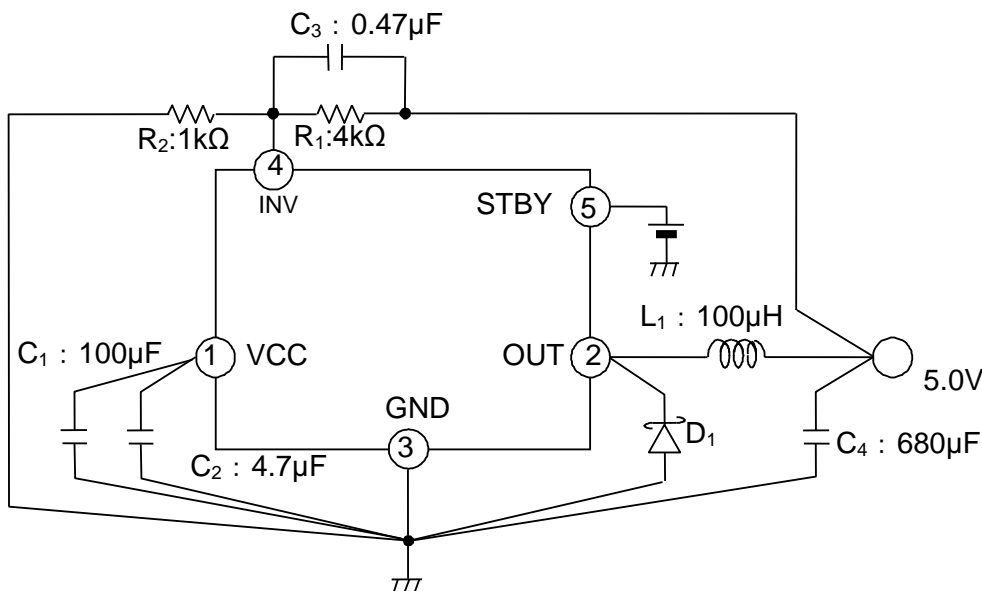

Figure 28. Layout

- (1) Place capacitors between VCC and Ground, and the Schottky diode as close as possible to the IC to reduce noise and maximize efficiency.
- (2) Connect resistors between INV and Ground, and the output capacitor filter at the same ground potential in order to stabilize the output voltage. (If the patterning is longer or thin, it's possible to cause ringing or waveform crack.)

3. Application Component Selection and Settings

(1) Inductor L₁

Large inductor series impedance will result in deterioration of efficiency. OCP operation greater than 1.6A(BD9873) or 3.2A(BD9874) may cause inductor overheating, possibly leading to overload or output short.

Note that the current rating for the coil should be higher than $I_{OUT(MAX)} + \Delta I_L$.

where:

$I_{OUT(MAX)}$ is the maximum load current.

If you allow current flow more than maximum current rating, the coil will overload, causing magnetic saturation, and those account for efficiency deterioration. Select a coil with enough current rating which doesn't exceed peak current.

$$\Delta I_L = \frac{(V_{CC} - V_{OUT})}{L_1} \times \frac{V_{OUT}}{V_{CC}} \times \frac{1}{f_{OSC}}$$

where:

L_i is the inductor value.

V_{CC} is the maximum input voltage.

V_{OUT} is the output voltage.

ΔI_L is the coil ripple current value.

f_{osc} is the oscillation frequency.

(2) Schottky Barrier Diode D₁

Select a Schottky diode having an inter-terminal capacity as small as possible (reverse recovery time as short as possible) and a forward voltage V_F as low as possible. (Noise can be reduced and efficiency improved by reduction of switching noise and switching loss, as well as reduction of voltage drop loss of forward voltage.)

Diode should be selected on the basis of maximum current rating in forward direction, voltage rating in reverse direction, and power dissipation of diode.

- The maximum current rating is higher than the combined maximum load current and coil ripple current (ΔI_L).
- The reverse voltage rating is higher than the IN value.
- Recommend using a diode with smaller the reverse current as possible
In the high temperature case, the reverse current is increasing and it may cause overdrive
- Power dissipation for the selected diode must be within the rated level.

The power dissipation of the diode is expressed by the following formula:

$$P_{di} = I_{OUT(MAX)} \times V_F \times (1 - V_{OUT} / V_{CC})$$

where:

$I_{OUT(MAX)}$ is the maximum load current.

V_F is the forward voltage.

V_{OUT} is the output voltage.

V_{CC} is the input voltage.

(3) Output Capacitor C₄

A suitable output capacitor should satisfy the following formula for ESR:

$$ESR \leq \Delta V_L / \Delta I_L$$

where:

ΔV_L is the permissible ripple voltage.

ΔI_L is the coil ripple current.

Another factor that must be considered is the permissible ripple current. Select a capacitor with sufficient margin, governed by the following formula:

$$I_{RMS} = \Delta I_L / 2\sqrt{3}$$

where:

I_{RMS} is the effective value of ripple current to the output capacitor

ΔI_L is the coil ripple current

The output capacitor is a major factor for system stability. When an inappropriate capacitor is selected, expected characteristics may not be guaranteed depending on ambient temperature, output voltage setting condition, etc. Fully confirm ESR, temperature characteristics, DC, and bias characteristics before evaluation.

(4) Input Capacitor C₁,C₂

The input capacitor is the source of current flow to the coil via the built-in P-Channel FET when the FET is ON. When selecting the input capacitor, sufficient margin must be provided to accommodate capacitor voltage and permissible ripple current. The expression below defines the effective value of the ripple current to the input capacitor. It should be used in determining the suitability of the capacitor in providing sufficient margin for the permissible ripple current.

$$I_{RMS} = I_{OUT} \times \sqrt{(1 - V_{OUT} / V_{CC}) \times V_{OUT} / V_{CC}}$$

where:

I_{RMS} is the effective value of the ripple current to the input capacitor.

I_{OUT} is the output load current.

V_{OUT} is the output voltage.

V_{CC} is the input voltage.

(5) Capacitor, C₃

This capacitor is utilized to stabilize the frequency characteristics.

When C₃ is removed, overshoot or undershoot may occur during start-up or in rapid change of load.

Be sure to insert 0.47 μF.

(6) Resistor R₁, R₂

These resistors determine the output voltage:

$$V_{OUT} = 1.0V \times (1 + R_1 / R_2)$$

Select resistors less than 10kΩ.

BD9873CP-V5

<Recommended Components (Example)>

Inductor	L ₁ =100μH	: RCR1616 (SUMIDA)
Schottky Diode	D ₁ = RB050LA-40 (ROHM)	
Capacitor	C ₁ =100μF	: Al electrolytic capacitor
	C ₂ =4.7μF	: Laminated ceramic capacitor
	C ₃ =0.47μF	: Laminated ceramic capacitor
	C ₄ =680μF	: Al electrolytic capacitor

BD9874CP-V5

<Recommended Components (Example)>

Inductor	L ₁ =100μH	: RCR1616 (SUMIDA)
Schottky Diode	D ₁ =RB050LA-40(ROHM)	
Capacitor	C ₁ =100μF	: Al electrolytic capacitor
	C ₂ = 4.7μF	:Laminated ceramic capacitor
	C ₃ = 0.47μF	:Laminated ceramic capacitor
	C ₄ = 680μF	: Al electrolytic capacitor

4. Tj (Tip Junction Temperature) Calculating Method

It is impossible to measure the tip junction temperature Tj outside the IC, but it can be calculated by the formula shown below.

Calculation method of tip junction temperature Tj

$$T_j = (W \times \theta_j - c) + T_c$$

where:

W is the Power consumed by IC (calculated by the formula below)

$\theta_j - c$ is the Thermal resistance from the tip to the back of the package 12.5 °C/W for TO220 package

T_c is the IC surface temperature (to be measured by thermocouple, etc.)

Calculation method of electric power W consumed by IC

$$W = V_{IN} \times I_{IN} - V_{OUT} \times I_{OUT} - V_F \times I_{OUT} \times (1 - V_{OUT} / V_{IN})$$

Where:

V_{IN} is the Input voltage

I_{IN} is the Input current

V_{OUT} is the Output voltage

I_{OUT} is the Load Current

V_F is the forward voltage of Schottky diode

Power Dissipation

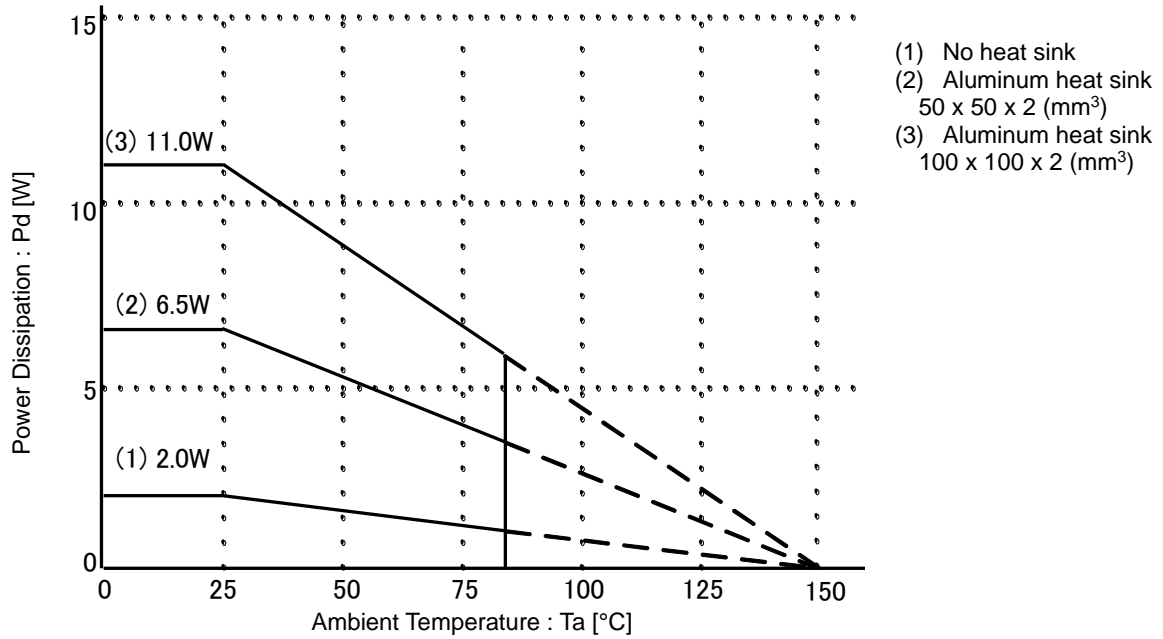

Figure 29. Power Dissipation

I/O Equivalent Circuit

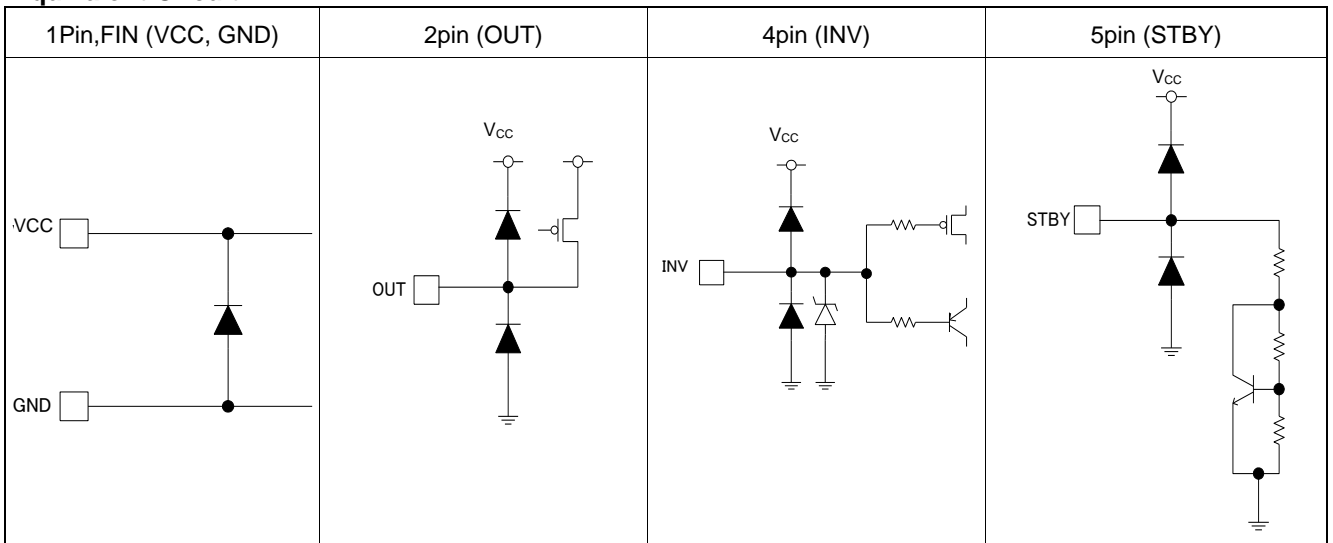

Figure 30. Input Output Equivalent Circuit

Operational Notes

1. Reverse Connection of Power Supply

Connecting the power supply in reverse polarity can damage the IC. Take precautions against reverse polarity when connecting the power supply, such as mounting an external diode between the power supply and the IC's power supply pins.

2. Power Supply Lines

Design the PCB layout pattern to provide low impedance supply lines. Separate the ground and supply lines of the digital and analog blocks to prevent noise in the ground and supply lines of the digital block from affecting the analog block. Furthermore, connect a capacitor to ground at all power supply pins. Consider the effect of temperature and aging on the capacitance value when using electrolytic capacitors.

3. Ground Voltage

Ensure that no pins are at a voltage below that of the ground pin at any time, even during transient condition.

4. Ground Wiring Pattern

When using both small-signal and large-current ground traces, the two ground traces should be routed separately but connected to a single ground at the reference point of the application board to avoid fluctuations in the small-signal ground caused by large currents. Also ensure that the ground traces of external components do not cause variations on the ground voltage. The ground lines must be as short and thick as possible to reduce line impedance.

5. Thermal Consideration

Should by any chance the power dissipation rating be exceeded the rise in temperature of the chip may result in deterioration of the properties of the chip. In case of exceeding this absolute maximum rating, increase the board size and copper area to prevent exceeding the Pd rating.

6. Recommended Operating Conditions

These conditions represent a range within which the expected characteristics of the IC can be approximately obtained. The electrical characteristics are guaranteed under the conditions of each parameter.

7. Inrush Current

When power is first supplied to the IC, it is possible that the internal logic may be unstable and inrush current may flow instantaneously due to the internal powering sequence and delays, especially if the IC has more than one power supply. Therefore, give special consideration to power coupling capacitance, power wiring, width of ground wiring, and routing of connections.

8. Operation Under Strong Electromagnetic Field

Operating the IC in the presence of a strong electromagnetic field may cause the IC to malfunction.

9. Testing on Application Boards

When testing the IC on an application board, connecting a capacitor directly to a low-impedance output pin may subject the IC to stress. Always discharge capacitors completely after each process or step. The IC's power supply should always be turned off completely before connecting or removing it from the test setup during the inspection process. To prevent damage from static discharge, ground the IC during assembly and use similar precautions during transport and storage.

10. Inter-pin Short and Mounting Errors

Ensure that the direction and position are correct when mounting the IC on the PCB. Incorrect mounting may result in damaging the IC. Avoid nearby pins being shorted to each other especially to ground, power supply and output pin. Inter-pin shorts could be due to many reasons such as metal particles, water droplets (in very humid environment) and unintentional solder bridge deposited in between pins during assembly to name a few.

Operational Notes – continued

11. **Unused Input Pins**

Input pins of an IC are often connected to the gate of a MOS transistor. The gate has extremely high impedance and extremely low capacitance. If left unconnected, the electric field from the outside can easily charge it. The small charge acquired in this way is enough to produce a significant effect on the conduction through the transistor and cause unexpected operation of the IC. So unless otherwise specified, unused input pins should be connected to the power supply or ground line.

12. **Regarding the Input Pin of the IC**

This monolithic IC contains P+ isolation and P substrate layers between adjacent elements in order to keep them isolated. P-N junctions are formed at the intersection of the P layers with the N layers of other elements, creating a parasitic diode or transistor. For example (refer to figure below):

When $GND > Pin A$ and $GND > Pin B$, the P-N junction operates as a parasitic diode.
 When $GND > Pin B$, the P-N junction operates as a parasitic transistor.

Parasitic diodes inevitably occur in the structure of the IC. The operation of parasitic diodes can result in mutual interference among circuits, operational faults, or physical damage. Therefore, conditions that cause these diodes to operate, such as applying a voltage lower than the GND voltage to an input pin (and thus to the P substrate) should be avoided.

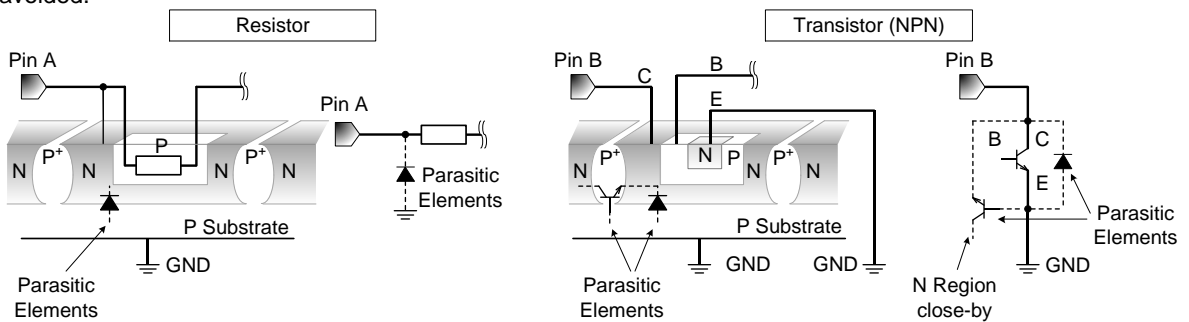

Figure 31. Example of monolithic IC structure

13. **Thermal Shutdown Circuit(TSD)**

This IC has a built-in thermal shutdown circuit that prevents heat damage to the IC. Normal operation should always be within the IC's power dissipation rating. If however the rating is exceeded for a continued period, the junction temperature (T_j) will rise which will activate the TSD circuit that will turn OFF all output pins. When the T_j falls below the TSD threshold, the circuits are automatically restored to normal operation.

Note that the TSD circuit operates in a situation that exceeds the absolute maximum ratings and therefore, under no circumstances, should the TSD circuit be used in a set design or for any purpose other than protecting the IC from heat damage.

Ordering Information

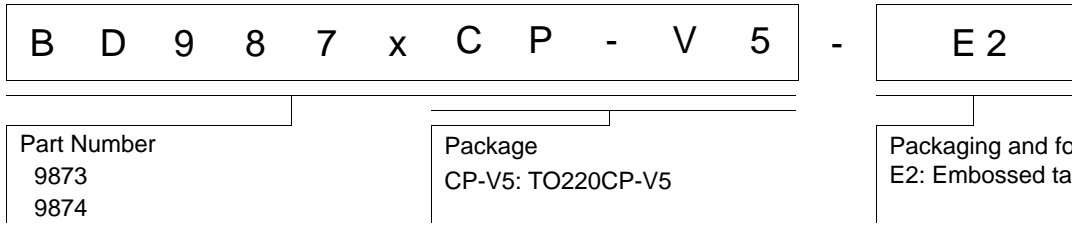

Lineup

Maximum Output Current (Max)	Part Number Marking	Package		Orderable Part Number
1.5 A	BD9873CP	TO220CP-V5	Reel of 500	BD9873CP-V5E2
3.0 A	BD9874CP	TO220CP-V5	Reel of 500	BD9874CP-V5E2

Marking Diagram

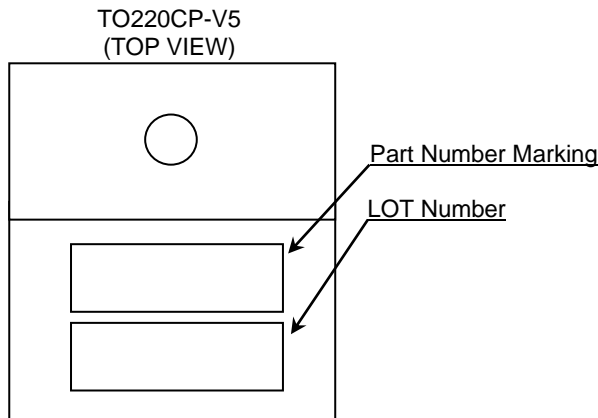

Physical Dimension, Tape and Reel information

Package Name	TO220CP-V5
--------------	------------

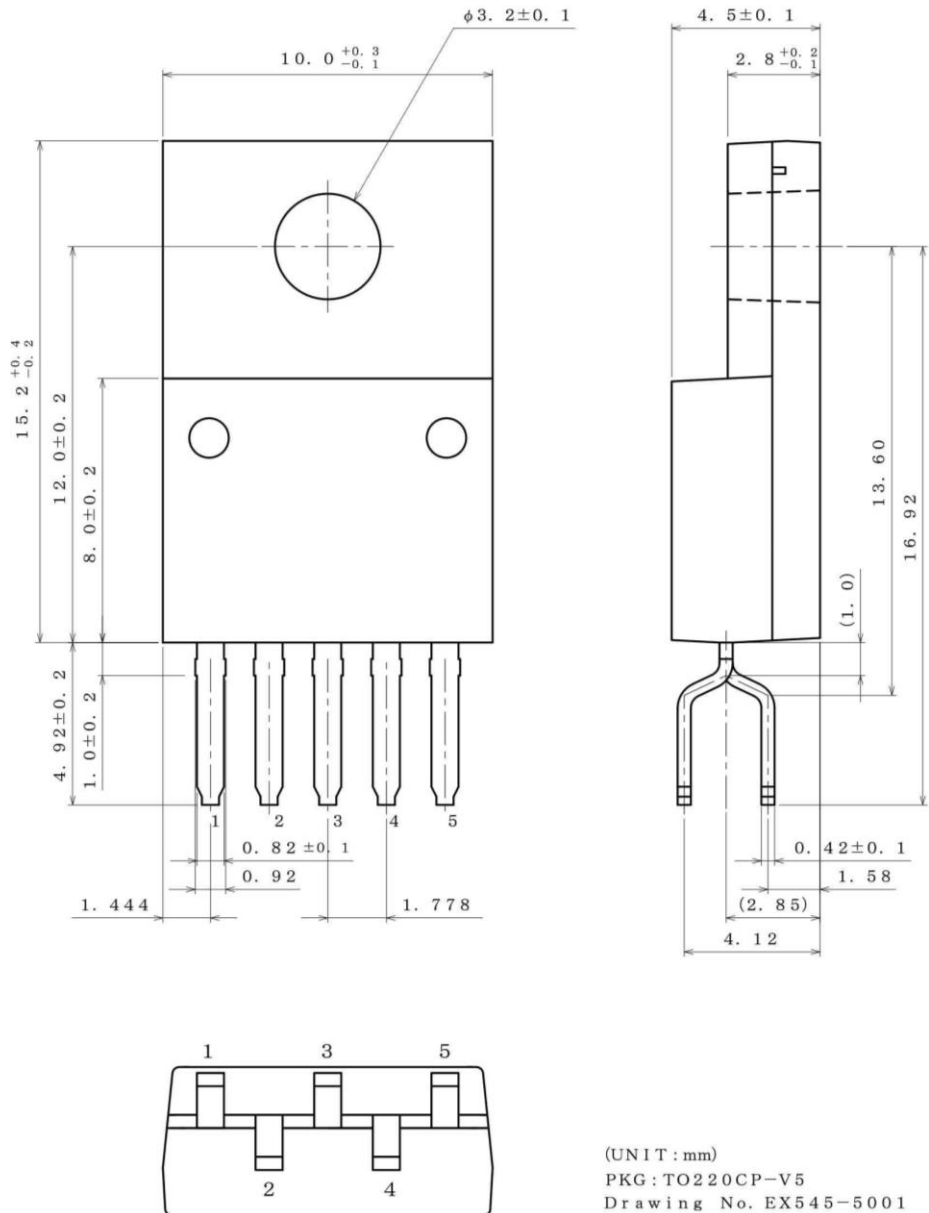

(UNIT : mm)
 PKG : TO220CP-V5
 Drawing No. EX545-5001

< Tape and Reel Information >

Tape	Embossed carrier tape
Quantity	500pcs
Direction of feed	E2 The direction is the pin 1 of product is at the upper left when you hold reel on the left hand and you pull out the tape on the right hand

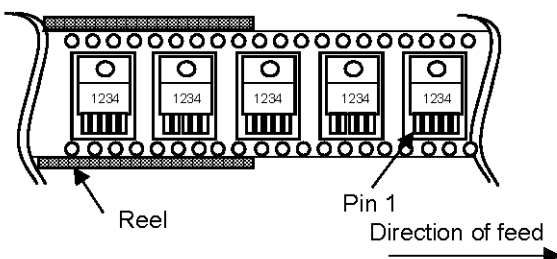

Revision History

Date	Revision	Changes
05.Nov.2014	001	New Release

Notice

Precaution on using ROHM Products

- Our Products are designed and manufactured for application in ordinary electronic equipments (such as AV equipment, OA equipment, telecommunication equipment, home electronic appliances, amusement equipment, etc.). If you intend to use our Products in devices requiring extremely high reliability (such as medical equipment ^(Note 1), transport equipment, traffic equipment, aircraft/spacecraft, nuclear power controllers, fuel controllers, car equipment including car accessories, safety devices, etc.) and whose malfunction or failure may cause loss of human life, bodily injury or serious damage to property ("Specific Applications"), please consult with the ROHM sales representative in advance. Unless otherwise agreed in writing by ROHM in advance, ROHM shall not be in any way responsible or liable for any damages, expenses or losses incurred by you or third parties arising from the use of any ROHM's Products for Specific Applications.

(Note1) Medical Equipment Classification of the Specific Applications

JAPAN	USA	EU	CHINA
CLASS III	CLASS III	CLASS II b	CLASS III
CLASS IV		CLASS III	

- ROHM designs and manufactures its Products subject to strict quality control system. However, semiconductor products can fail or malfunction at a certain rate. Please be sure to implement, at your own responsibilities, adequate safety measures including but not limited to fail-safe design against the physical injury, damage to any property, which a failure or malfunction of our Products may cause. The following are examples of safety measures:
 - Installation of protection circuits or other protective devices to improve system safety
 - Installation of redundant circuits to reduce the impact of single or multiple circuit failure
- Our Products are designed and manufactured for use under standard conditions and not under any special or extraordinary environments or conditions, as exemplified below. Accordingly, ROHM shall not be in any way responsible or liable for any damages, expenses or losses arising from the use of any ROHM's Products under any special or extraordinary environments or conditions. If you intend to use our Products under any special or extraordinary environments or conditions (as exemplified below), your independent verification and confirmation of product performance, reliability, etc. prior to use, must be necessary:
 - Use of our Products in any types of liquid, including water, oils, chemicals, and organic solvents
 - Use of our Products outdoors or in places where the Products are exposed to direct sunlight or dust
 - Use of our Products in places where the Products are exposed to sea wind or corrosive gases, including Cl₂, H₂S, NH₃, SO₂, and NO₂
 - Use of our Products in places where the Products are exposed to static electricity or electromagnetic waves
 - Use of our Products in proximity to heat-producing components, plastic cords, or other flammable items
 - Sealing or coating our Products with resin or other coating materials
 - Use of our Products without cleaning residue of flux (even if you use no-clean type fluxes, cleaning residue of flux is recommended); or Washing our Products by using water or water-soluble cleaning agents for cleaning residue after soldering
 - Use of the Products in places subject to dew condensation
- The Products are not subject to radiation-proof design.
- Please verify and confirm characteristics of the final or mounted products in using the Products.
- In particular, if a transient load (a large amount of load applied in a short period of time, such as pulse. is applied, confirmation of performance characteristics after on-board mounting is strongly recommended. Avoid applying power exceeding normal rated power; exceeding the power rating under steady-state loading condition may negatively affect product performance and reliability.
- De-rate Power Dissipation (Pd) depending on Ambient temperature (Ta). When used in sealed area, confirm the actual ambient temperature.
- Confirm that operation temperature is within the specified range described in the product specification.
- ROHM shall not be in any way responsible or liable for failure induced under deviant condition from what is defined in this document.

Precaution for Mounting / Circuit board design

- When a highly active halogenous (chlorine, bromine, etc.) flux is used, the residue of flux may negatively affect product performance and reliability.
- In principle, the reflow soldering method must be used on a surface-mount products, the flow soldering method must be used on a through hole mount products. If the flow soldering method is preferred on a surface-mount products, please consult with the ROHM representative in advance.

For details, please refer to ROHM Mounting specification

Precautions Regarding Application Examples and External Circuits

1. If change is made to the constant of an external circuit, please allow a sufficient margin considering variations of the characteristics of the Products and external components, including transient characteristics, as well as static characteristics.
2. You agree that application notes, reference designs, and associated data and information contained in this document are presented only as guidance for Products use. Therefore, in case you use such information, you are solely responsible for it and you must exercise your own independent verification and judgment in the use of such information contained in this document. ROHM shall not be in any way responsible or liable for any damages, expenses or losses incurred by you or third parties arising from the use of such information.

Precaution for Electrostatic

This Product is electrostatic sensitive product, which may be damaged due to electrostatic discharge. Please take proper caution in your manufacturing process and storage so that voltage exceeding the Products maximum rating will not be applied to Products. Please take special care under dry condition (e.g. Grounding of human body / equipment / solder iron, isolation from charged objects, setting of Ionizer, friction prevention and temperature / humidity control).

Precaution for Storage / Transportation

1. Product performance and soldered connections may deteriorate if the Products are stored in the places where:
 - [a] the Products are exposed to sea winds or corrosive gases, including Cl₂, H₂S, NH₃, SO₂, and NO₂
 - [b] the temperature or humidity exceeds those recommended by ROHM
 - [c] the Products are exposed to direct sunshine or condensation
 - [d] the Products are exposed to high Electrostatic
2. Even under ROHM recommended storage condition, solderability of products out of recommended storage time period may be degraded. It is strongly recommended to confirm solderability before using Products of which storage time is exceeding the recommended storage time period.
3. Store / transport cartons in the correct direction, which is indicated on a carton with a symbol. Otherwise bent leads may occur due to excessive stress applied when dropping of a carton.
4. Use Products within the specified time after opening a humidity barrier bag. Baking is required before using Products of which storage time is exceeding the recommended storage time period.

Precaution for Product Label

QR code printed on ROHM Products label is for ROHM's internal use only.

Precaution for Disposition

When disposing Products please dispose them properly using an authorized industry waste company.

Precaution for Foreign Exchange and Foreign Trade act

Since our Products might fall under controlled goods prescribed by the applicable foreign exchange and foreign trade act, please consult with ROHM representative in case of export.

Precaution Regarding Intellectual Property Rights

1. All information and data including but not limited to application example contained in this document is for reference only. ROHM does not warrant that foregoing information or data will not infringe any intellectual property rights or any other rights of any third party regarding such information or data. ROHM shall not be in any way responsible or liable for infringement of any intellectual property rights or other damages arising from use of such information or data.:
2. No license, expressly or implied, is granted hereby under any intellectual property rights or other rights of ROHM or any third parties with respect to the information contained in this document.

Other Precaution

1. This document may not be reprinted or reproduced, in whole or in part, without prior written consent of ROHM.
2. The Products may not be disassembled, converted, modified, reproduced or otherwise changed without prior written consent of ROHM.
3. In no event shall you use in any way whatsoever the Products and the related technical information contained in the Products or this document for any military purposes, including but not limited to, the development of mass-destruction weapons.
4. The proper names of companies or products described in this document are trademarks or registered trademarks of ROHM, its affiliated companies or third parties.

General Precaution

1. Before you use our Products, you are requested to carefully read this document and fully understand its contents. ROHM shall not be in any way responsible or liable for failure, malfunction or accident arising from the use of any ROHM's Products against warning, caution or note contained in this document.
2. All information contained in this document is current as of the issuing date and subject to change without any prior notice. Before purchasing or using ROHM's Products, please confirm the latest information with a ROHM sales representative.
3. The information contained in this document is provided on an "as is" basis and ROHM does not warrant that all information contained in this document is accurate and/or error-free. ROHM shall not be in any way responsible or liable for any damages, expenses or losses incurred by you or third parties resulting from inaccuracy or errors of or concerning such information.