

AC/DC Converter

Built-in Switching MOSFET PWM-type DC/DC Converter IC

BM2P10xxJ-Z series
General Description

This series of PWM-type DC/DC converters for AC/DC supplies the optimum system for all products in which an outlet is present. It is compatible with both insulated and non-insulated, and various types of low-power consumption converters can be easily designed.

The built-in 730 V startup circuit contributes to low power dissipation. A highly flexible power supply design is achieved by externally installing a current detection resistor for switching. Because of the use of current mode control, the current is limited every cycle, providing excellent performance in bandwidth and excessive response. The switching frequency is fixed at 100 kHz. When turned light load, the frequency is reduced to achieve high efficiency. Built-in frequency hopping function contributes to low EMI. Built-in 730 V switching MOSFET enables easy designing.

Features

- PWM Current Mode Control
- Frequency Hopping Function
- Burst Operation at Light Load
- Frequency Reduction Function
- Built-in 730 V Startup Circuit
- Built-in 730 V Switching MOSFET
- VCC UVLO (Under Voltage Lockout)
- VCC OVP (Over Voltage Protection)
- SOURCE Pin Open Protection
- SOURCE Pin Function of Leading Edge Blanking
- Over Current Detection Function per Cycle
- Over Current Detection AC Compensation Function
- Soft Start Function
- Secondary Over Current Protection Circuit

Key Specifications

- Operating Power Supply Voltage Range:
VCC Pin: 8.9 V to 26.0 V
DRAIN Pin: 730 V (Max)
- Circuit Current (ON) 1:
BM2P10x1J-Z: 0.90 mA (Typ)
BM2P10x3J-Z: 0.65 mA (Typ)
- Circuit Current (ON) 2: 0.30 mA (Typ)
- Frequency Range 1: 100 kHz (Typ)
- Operating Temperature Range: -40 °C to +105 °C
- MOSFET ON Resistance:
BM2P10x1J-Z: 1.0 Ω (Typ)
BM2P10x3J-Z: 3.0 Ω (Typ)

Package

DIP7K

W (Typ) x D (Typ) x H (Max)

9.27 mm x 6.35 mm x 8.63 mm

Pitch 2.54 mm

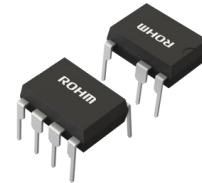
Lineup

Product Name	MOSFET ON resistance	VH UVLO	VH OVP
BM2P10A1J-Z	1.0 Ω	○	-
BM2P10A3J-Z	3.0 Ω	○	-
BM2P10B1J-Z	1.0 Ω	○	○
BM2P10B3J-Z	3.0 Ω	○	○

Output Power (POUT)

Product Name	POUT (Note 1)	
	AC 230 V	AC 85 V to AC 264 V
BM2P10x1J-Z	35 W	30 W
BM2P10x3J-Z	30 W	20 W

(Note 1) Output power affects external components and thermal design. Therefore, it may be smaller than the stated value.

Applications

Major Appliance, Office Automation Equipment, AV Equipment, other SMPS etc.

Typical Application Circuit

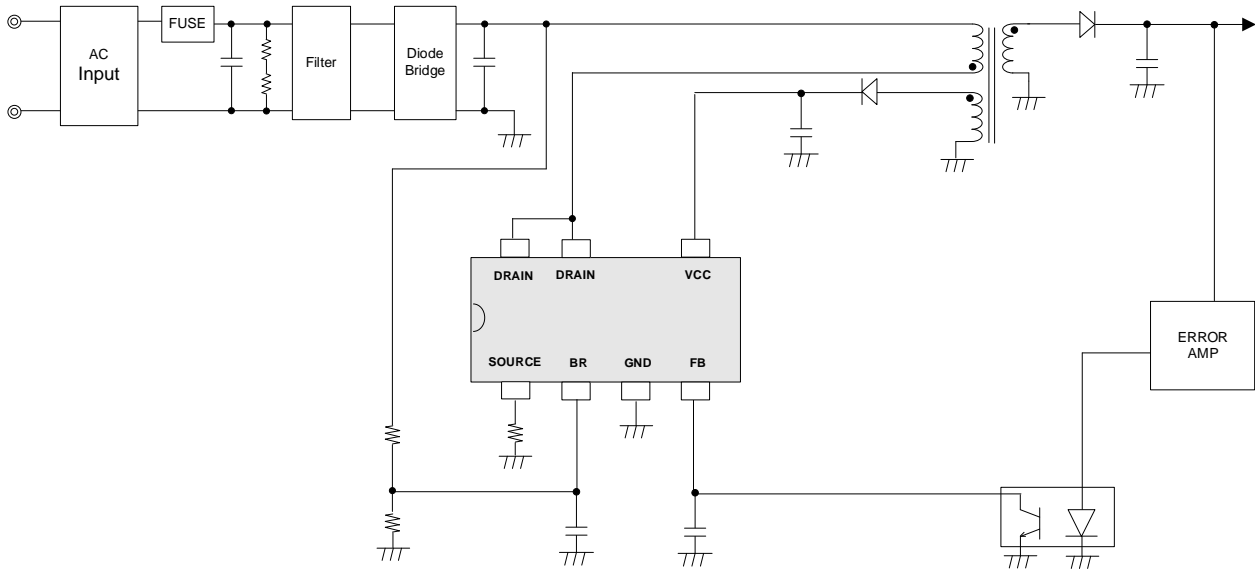

Pin Configuration

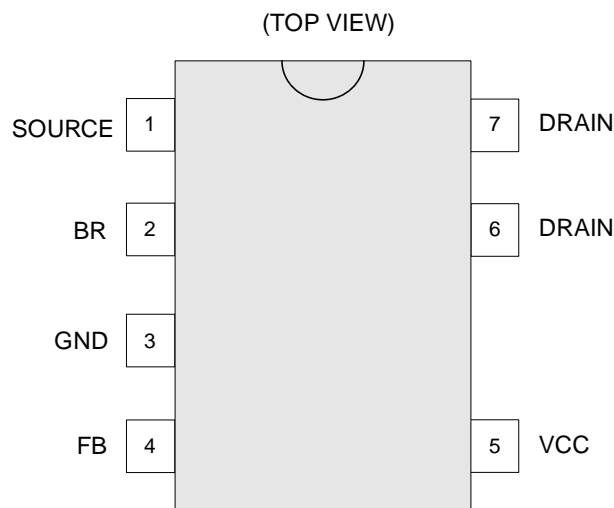

Pin Descriptions

Pin No.	Pin Name	I/O	Function	ESD Diode	
				VCC	GND
1	SOURCE	I/O	MOSFET SOURCE pin	-	o
2	BR	I	BROWNOUT pin	-	o
3	GND	I/O	GND pin	o	-
4	FB	I/O	Feedback-signal-in pin	-	o
5	VCC	I	Power supply input pin	-	o
6	DRAIN	I/O	MOSFET DRAIN pin	-	-
7	DRAIN	I/O	MOSFET DRAIN pin	-	-

Block Diagram

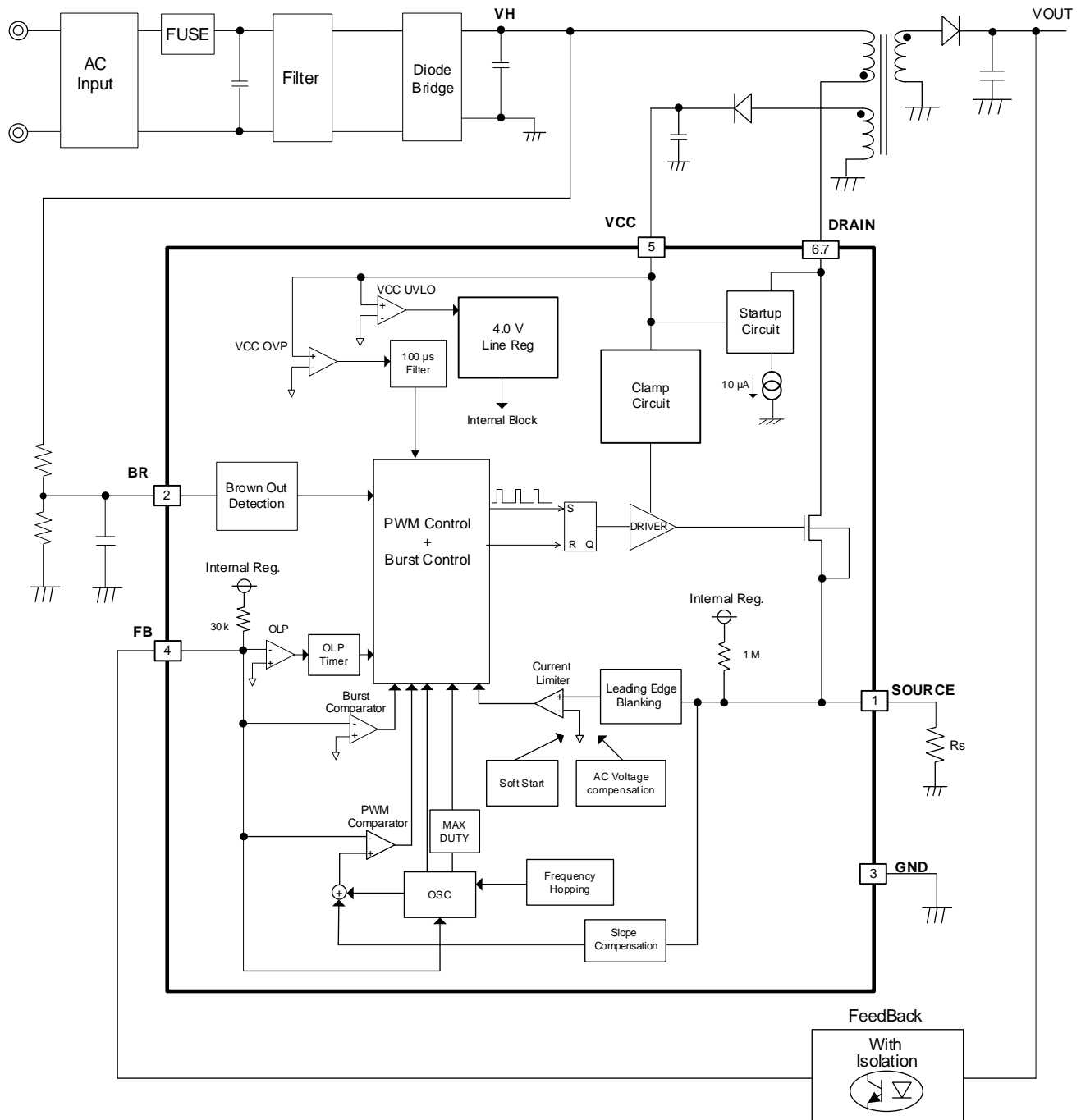

Description of Blocks

1. Startup Circuit (DRAIN: pin 6, pin 7)

This IC has a built-in startup circuit. Therefore, low standby power and high-speed startup are possible. After startup, only the idle current I_{START3} is consumed. Figure 3 shows the startup time reference. When $C_{VCC} = 10 \mu\text{F}$, it can be started at 0.1 s or less.

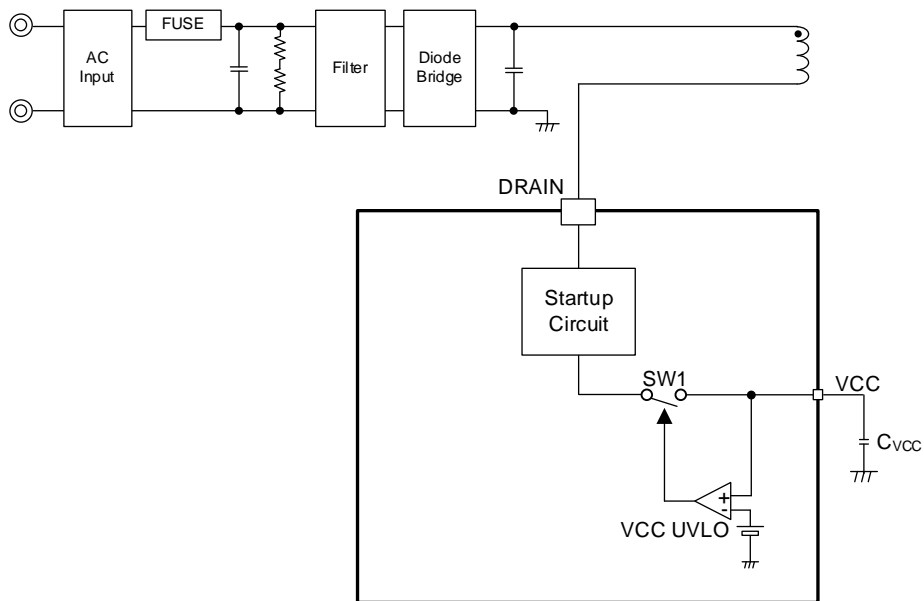

Figure 1. Block Diagram of Startup Circuit

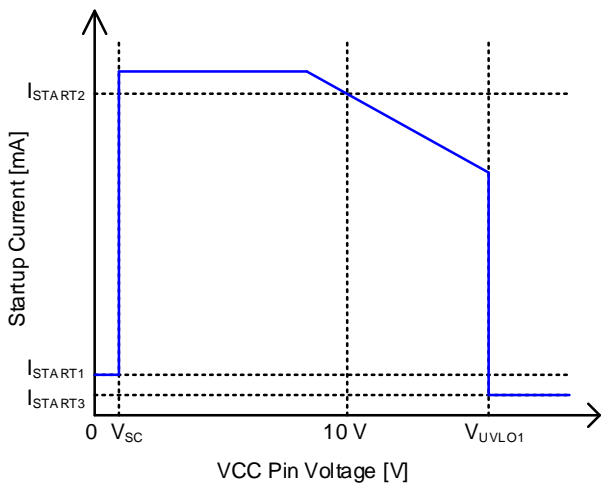

Figure 2. Startup Current vs VCC Pin Voltage

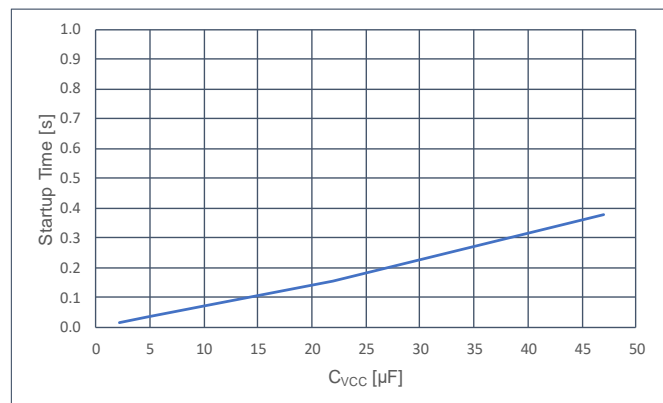

Figure 3. Startup Time vs C_{VCC}

Startup current is the current from the DRAIN pin.

e.g.) When $V_{ac} = 100 \text{ V}$, power consumed by startup circuit alone

$$PVH = 100 \text{ V} \times \sqrt{2} \times 10 \mu\text{A} = 1.41 \text{ mW}$$

e.g.) When $V_{ac} = 240 \text{ V}$, power consumed by startup circuit alone

$$PVH = 240 \text{ V} \times \sqrt{2} \times 10 \mu\text{A} = 3.39 \text{ mW}$$

Description of Blocks – continued

2. Startup Sequence

The startup sequence is shown in Figure 4. Details are described in each chapter.

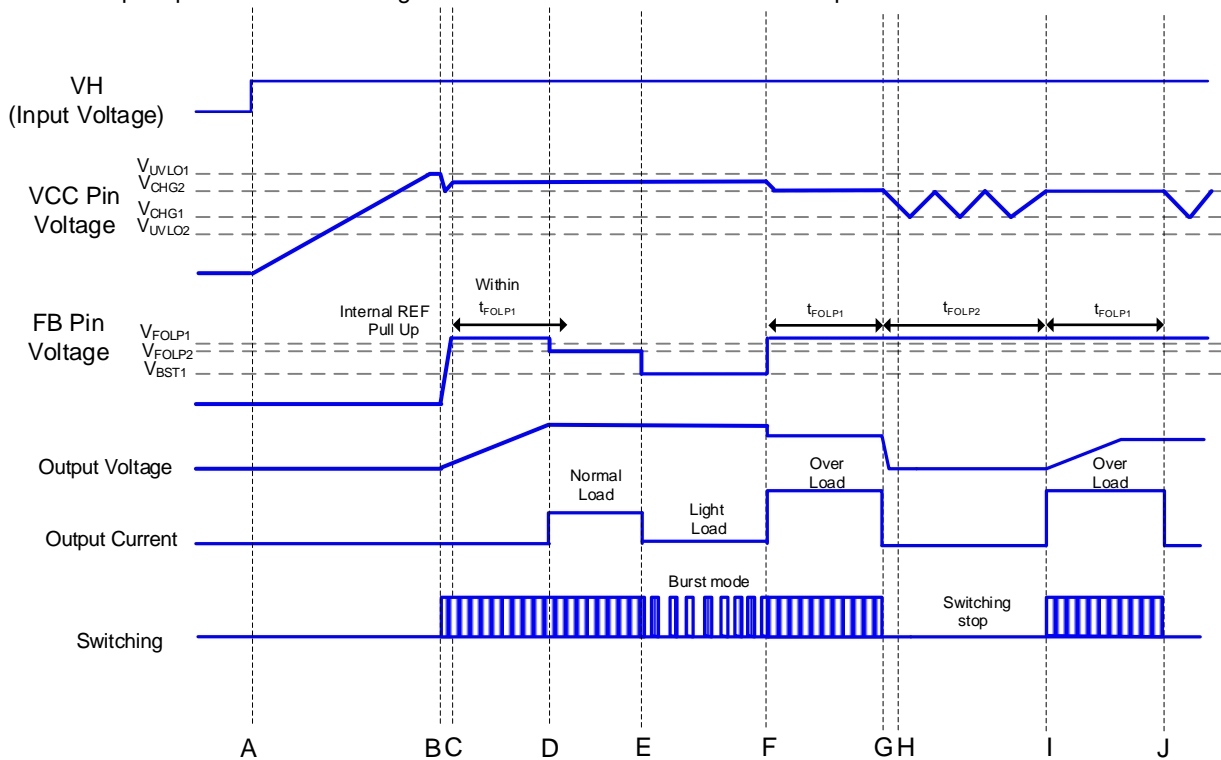

Figure 4. Startup Sequences Timing Chart

- A: Input voltage V_H is applied.
- B: When the VCC pin voltage rises and the VCC pin voltage $> V_{UVLO1}$, the IC starts operating. When it is judged that other protection functions are normal, switching operation starts. the VCC pin voltage drops depending on the VCC pin current consumed until the secondary output voltage rises above a certain level from the start of startup. Therefore, set it so that the VCC pin voltage $> V_{UVLO2}$ until switching starts.
- C: It has the soft start function to limit the over current detection value so that excessive voltage rise, and current rise do not occur.
- D: When switching operation starts, output voltage rises. After switching starts, set the output voltage so that it becomes the specified voltage within t_{FOLP1} .
- E: When light load and the FB pin voltage is $< V_{BST1}$, it is burst operation to reduce power consumption.
- F: Overload operation when the FB pin voltage $> V_{FOLP1}$.
- G: If the FB pin voltage $> V_{FOLP1}$ continues for t_{FOLP1} , the overload protector stops switching for the duration of t_{FOLP2} . When the FB pin voltage $< V_{FOLP2}$, the IC-internal timer t_{FOLP1} is reset.
- H: The VCC pin voltage rises due to the recharging operation when the VCC pin voltage $< V_{CHG1}$. Also, when the VCC pin voltage $> V_{CHG2}$, the recharge operation is stopped.
- I: After t_{FOLP2} has elapsed, switching starts with the soft start function.
- J: Same as G.

Description of Blocks – continued

3. VCC Pin Protective Function

This IC has a built-in VCC UVLO, VCC OVP, and a VCC recharge function that operates when the VCC pin voltage drops. The VCC recharge function charges a higher voltage line than the startup circuit to stabilize the secondary output voltage when the VCC pin voltage drops.

(1) VCC UVLO / VCC OVP Function

VCC UVLO and VCC OVP are auto recovery comparators with voltage-hysteresis.

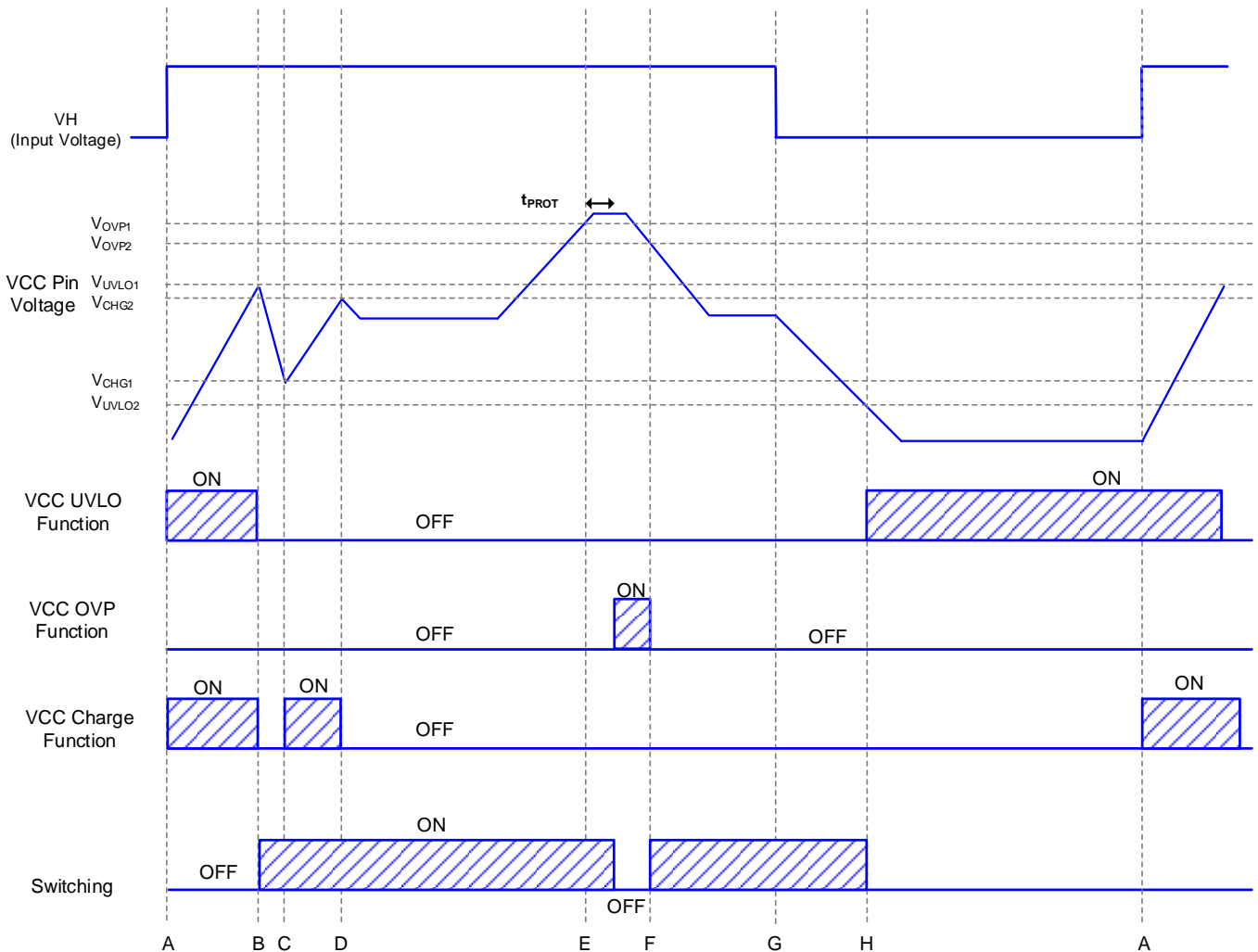

Figure 5. VCC UVLO / VCC OVP Timing Chart

- A: The VCC pin voltage starts rising after the input voltage VH is applied.
- B: The VCC pin voltage > V_UVLO1, VCC UVLO function is released and switching operation starts.
- C: The VCC pin voltage < V_CHG1, VCC recharge function operates and the VCC pin voltage rises.
- D: The VCC pin voltage > V_CHG2, VCC recharge function stops.
- E: When the VCC pin voltage > V_OVP1 status continues for t_PROT, the switching operation is stopped by VCC OVP function.
- F: The VCC pin voltage < V_OVP2, switching operation resumes.
- G: VH will be open and the VCC pin voltage will drop.
- H: The VCC pin voltage < V_UVLO2, VCC UVLO function is operated and switching operation stops.

3. VCC Pin Protective Function – continued

(2) VCC Recharge function

This IC has a built-in VCC recharge function.

Once the VCC pin voltage $> V_{UVLO1}$ and the IC starts, then when the VCC pin voltage $< V_{CHG1}$, the VCC recharge function operates. At this time, the VCC pin is charged from the DRAIN pin through startup circuit. This operation does not cause VCC startup failure.

When the VCC pin voltage is charged and the VCC pin voltage $> V_{CHG2}$, charging ends. This operation is shown in Figure 6.

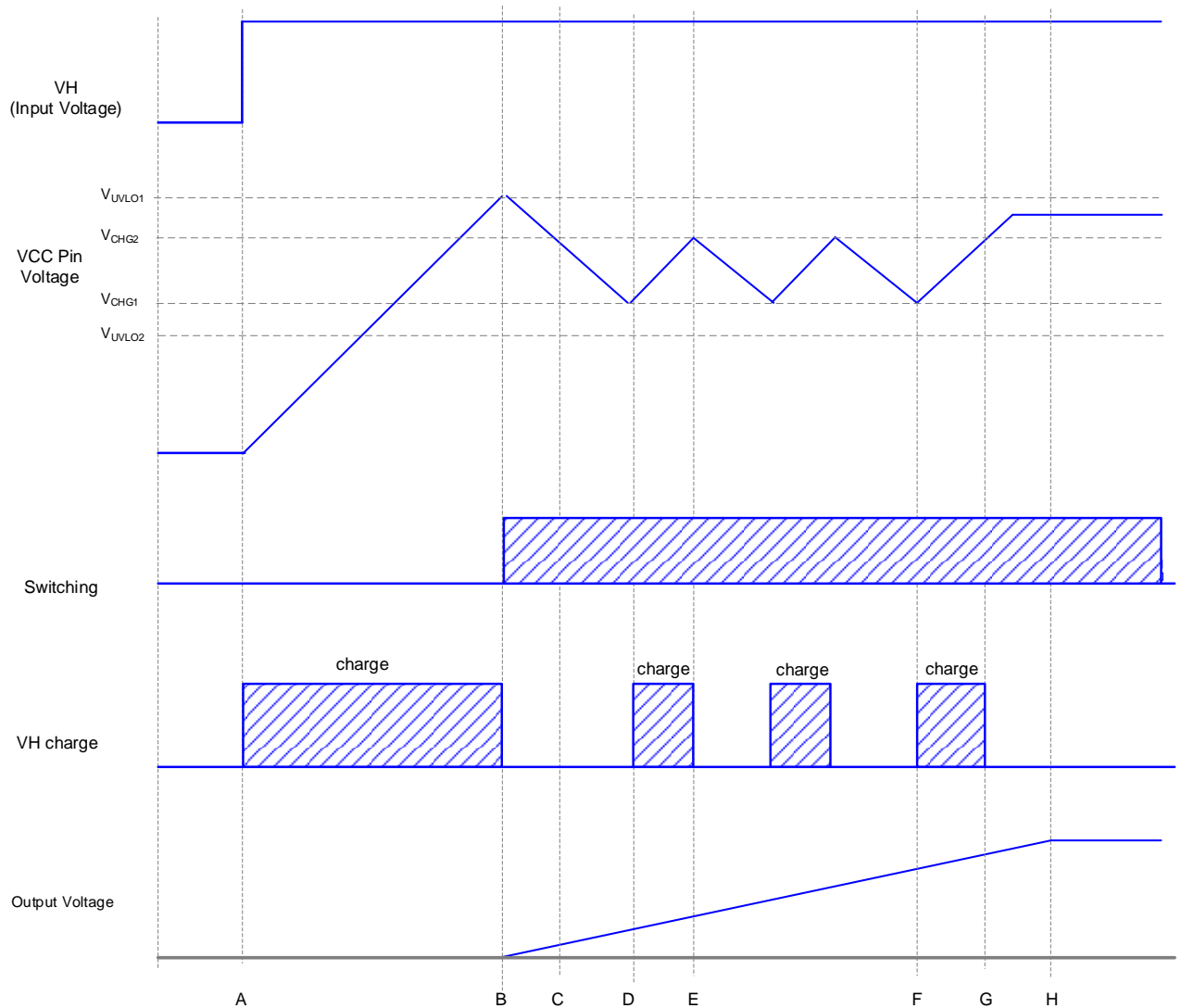

Figure 6. VCC Pin Recharge Operation

- A: The DRAIN pin voltage rises and the VCC pin is charged by the VCC recharge function.
- B: The VCC pin voltage $> V_{UVLO1}$, VCC UVLO function is deactivated, the VCC recharge function is deactivated, and switching operation begins.
- C: At startup, the VCC pin voltage drops due to the low output voltage.
- D: The VCC pin voltage $< V_{CHG1}$, the VCC recharge function operates to increase the VCC pin voltage.
- E: The VCC pin voltage $> V_{CHG2}$, VCC recharge function is disabled.
- F: The VCC pin voltage $< V_{CHG1}$, the VCC recharge function operates to increase the VCC pin voltage.
- G: The VCC pin voltage $> V_{CHG2}$, VCC recharge function is disabled.
- H: Output voltage finishes startup and is charged to the VCC pin from the secondary winding, and the VCC pin voltage is stabilized.

Description of Blocks – continued

4. DC/DC Drivers

This IC performs current mode PWM control.
 The switching frequency is fixed by the internal oscillator.
 Built-in switching frequency hopping function.

The max DUTY = D_{MAX} and min ON-width = t_{MIN} are fixed.
 In current mode control, subharmonic oscillation may occur if DUTY cycling exceeds 50 %.
 This slope compensation as a countermeasure protection circuits.
 A burst mode circuit and a frequency reduction circuit are built in to achieve low power dissipation during light load.
 The FB pin is pulled up to the internal power supply by R_{FB} .
 The FB pin voltage changes depending on the secondary output voltage (secondary load power).
 The FB pin voltage is monitored, and the switching operation status is switched.
 Figure 7 shows the FB pin voltage and DC/DC switching operation status.

- Mode 1: Burst operation
- Mode 2: Frequency fixed operation (operates in f_{SW2} .)
- Mode 3: Frequency-reduction operation (Reduces f_{SW1} .)
- Mode 4: Fixed-frequency operation (operates in f_{SW1})
- Mode 5: Overload operation (pulse operation stop, intermittent operation)

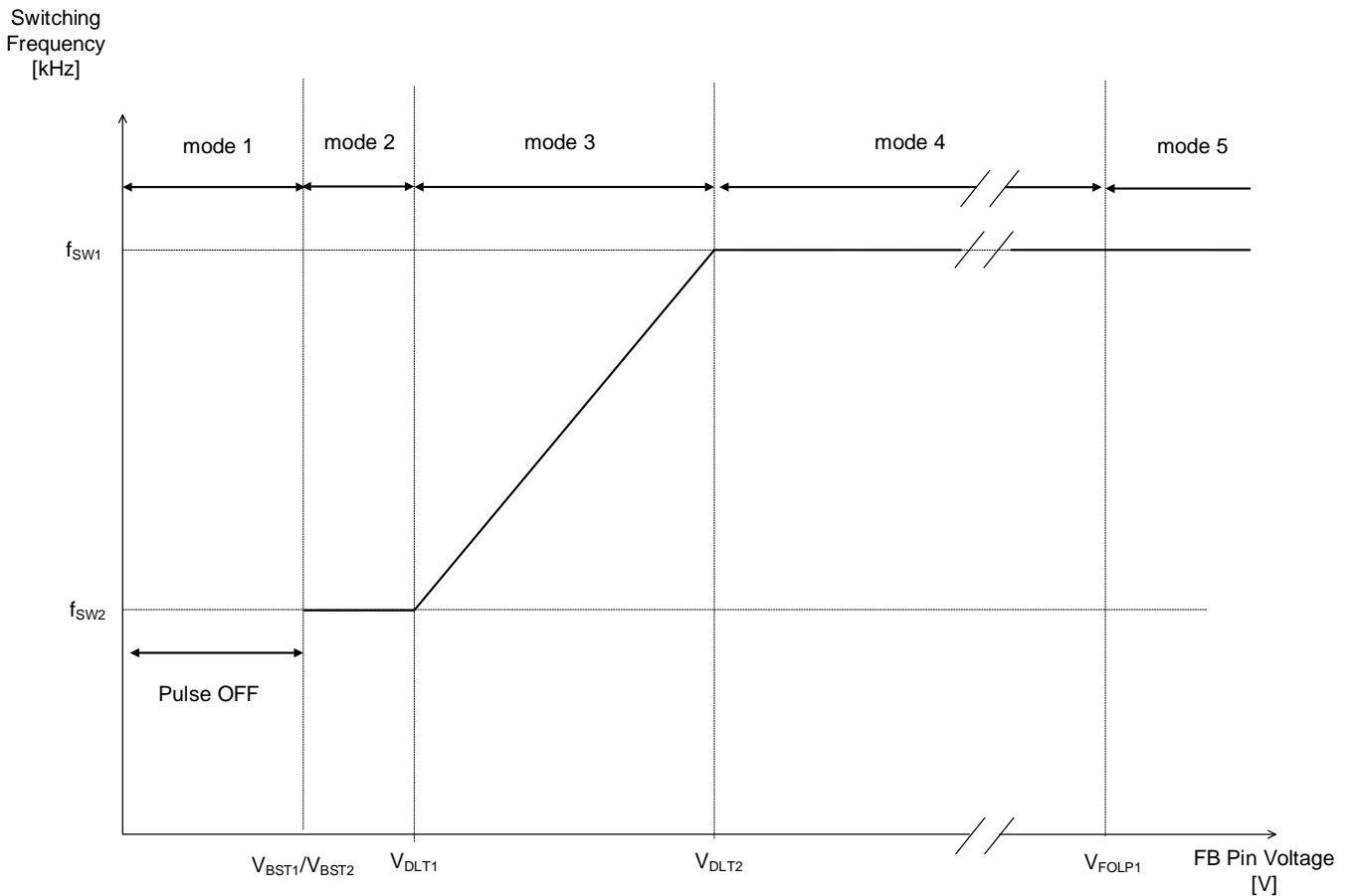

Figure 7. Switching Operation State Changes by FB Pin Voltage

Description of Blocks – continued

5. Over Current Detection Function

Built-in over current detection function for each switching cycle. Switching is stopped when the SOURCE pin exceeds a certain voltage. It has a built-in AC compensation function. This function is a compensation function that increases the over current detection level over time. It is shown in Figure 8 to 10.

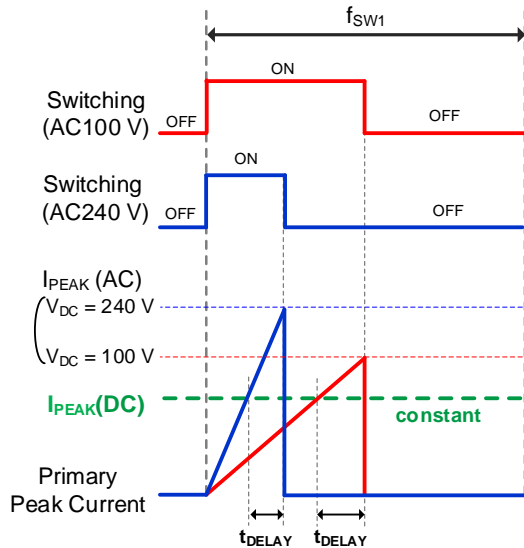

Figure 8. No AC Voltage Compensation Function

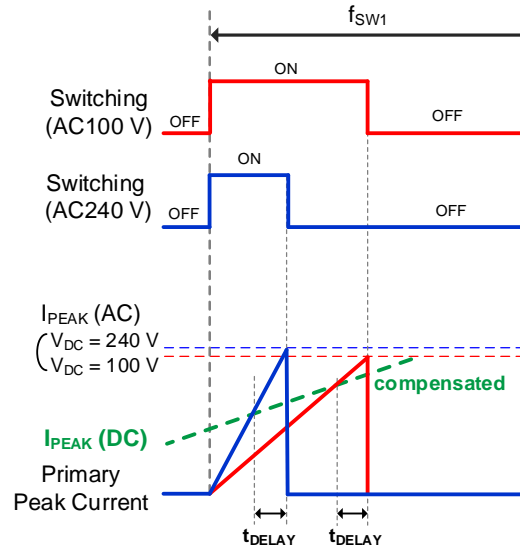

Figure 9. Built-in AC Compensation Voltage

The primary peak current entering the overload mode is determined by the following equation.

$$I_{PEAK} = \frac{V_{SOURCE}}{R_S} + \frac{V_{DC}}{L_p} \times t_{DELAY} \quad [A]$$

where:

V_{SOURCE} is the over current detection voltage inside the IC
 R_S is the current sensing resistor

V_{DC} is the input DC voltage
 L_p is the primary transformer L value

t_{DELAY} is the delay time after over current detection

Figure 10 shows the amount of AC correction for the over current detection voltage. Over time in the ON time, the over current limiter level increases from V_{OCP1} to V_{OCP2} . V_{OCP1} is the lower limit of AC correction, and V_{OCP2} is the upper limit of AC correction.

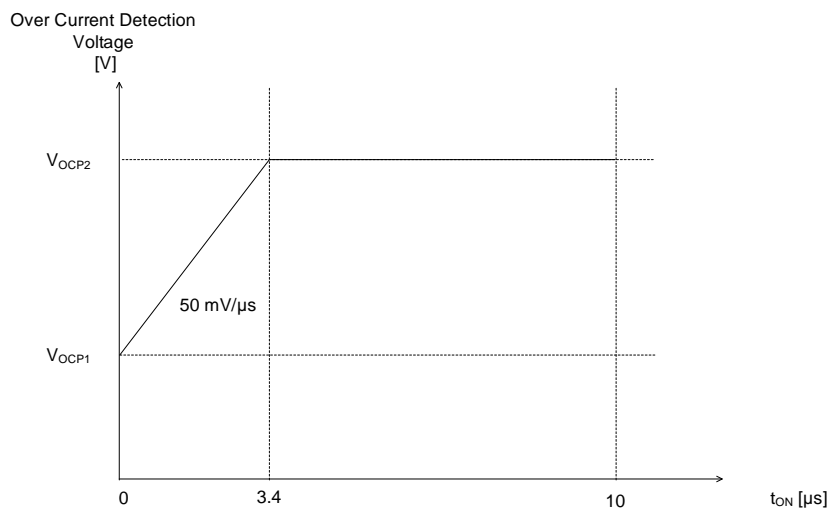

Figure 10. Over Current Detection Voltage

Description of Blocks – continued

6. Leading Edge Blanking Times

Surge current is generated by capacitive components, drive current, etc. when MOSFET for driving turns on. At this time, the SOURCE pin voltage rises temporarily, which may cause the over current detection circuit to detect incorrectly. To prevent false positives, the Leading Edge Blanking function is built-in. This function masks the SOURCE pin voltage for 250 ns after the DRAIN pin switches from H to L built-in.

7. SOURCE Pin Open Protection

If the SOURCE pin becomes open, excessive heat may be applied to the ICs due to noises, etc., and the IC may be damaged. An open protection circuit is built in to prevent damage. (Auto recovery)

8. FB OLP (Overload Protection)

FB OLP is a function that monitors the load status of the secondary output with the FB pin voltage and stops switching when it is overloaded.

In an overload condition, the output voltage drops, so that no current flows to the photocoupler, and the FB pin voltage rises.

If the FB pin voltage > V_{FOLP1} status lasts for t_{FOLP1} , it is judged to be overloaded and switching is stopped. If the FB pin voltage drops below V_{FOLP2} during t_{FOLP1} from the FB pin voltage > V_{FOLP1} , the overload protection timer is reset. Switching is performed during t_{FOLP1} . At startup, the FB pin is pulled up with a resistor to the internal voltage of the IC. Therefore, the IC operates from a voltage higher than V_{FOLP1} . Therefore, be sure to set the startup time so that the FB pin voltage is less than or equal to V_{FOLP2} value within t_{FOLP1} period during startup. Recovery from detection of FB OLP is after t_{FOLP2} .

9. VH Under Voltage Protective Function (VH UVLO)

When AC voltage is not supplied and VH becomes low voltage and the BR pin voltage < V_{INLVP1} , switching is stopped after t_{INLVP} .

When VH rises and the BR pin voltage > V_{INLVP2} , restart occurs due to soft start operation.

10. VH High-voltage Protective Function (VH OVP: BM2P10BxJ-Z only)

Switching is stopped when VH becomes high voltage and the BR pin voltage > V_{INOVP1} .

If VH decreases and the BR pin voltage < V_{INOVP2} , the system restarts.

11. Soft Start Function

This function controls the over current detection voltage in order to prevent any excessive voltage or current rising at startup. This IC enables the soft start operation by changing the over current detection voltage with time.

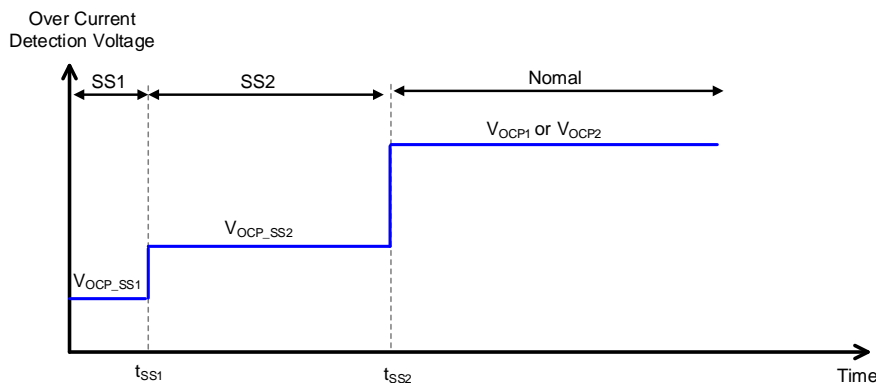

Figure 11. Soft Start Function

12. Dynamic Over Current Detection Function

This IC has a built-in dynamic over current detection function.

In the case that the SOURCE pin voltage exceeds the V_{DOC} two times consecutively, it stops the switching operation a certain period of time.

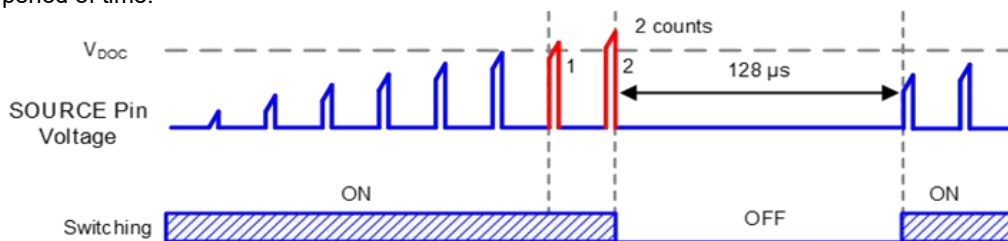

Figure 12. Dynamic Over Current Detection

Description of Blocks – continued

13. Operation Mode of Protection Function

Table 1 shows the operation modes of the protective functions.

Table 1. Operation Modes of Protection Functions

	VH UVLO	VH OVP (BM2P10BxJ-Z only)	VCC UVLO	VCC OVP
Detection Condition	BR pin voltage < V_{INLVP1}	BR pin voltage > V_{INOVP1}	VCC pin voltage < V_{UVLO2}	VCC pin voltage > V_{OVP1}
Release Conditions	BR pin voltage > V_{INLVP2}	BR pin voltage < V_{INOVP2}	VCC pin voltage > V_{UVLO1}	VCC pin voltage < V_{OVP2}
Detection Timer (Reset Condition)	t_{INLVP} (BR pin voltage > V_{INLVP2})	t_{INOVP} (BR pin voltage < V_{INOVP2})	–	t_{PROT} (VCC pin voltage < V_{OVP2})
Auto recovery or Latch	Auto recovery	Auto recovery	Auto recovery	Auto recovery

	Over Current Detection	FB OLP	TSD
Detection Condition	SOURCE pin voltage > V_{OCP1} or V_{OCP2}	FB pin voltage > V_{FOLP1}	$T_j > T_{SD1}$
Release Conditions	Each cycle	Expiration of t_{FOLP2}	$T_j < T_{SD2}$
Detection Timer (Reset Condition)	-	t_{FOLP1} (FB pin voltage < V_{FOLP2})	t_{PROT} ($T_j < T_{SD2}$)
Auto recovery or Latch	Auto recovery	Auto recovery	Auto recovery

Thermal Dissipation

Operate under the following conditions in thermal design.

- 1. The ambient temperature. T_a shall be 105 °C or less.
- 2. The power dissipation of the IC is less than or equal to the power dissipation P_d .

Thermal derating characteristics are as follows.
(PCBs: 74.2 mm x 74.2 mm x 1.6 mm when mounting single-layer glass epoxy boards)

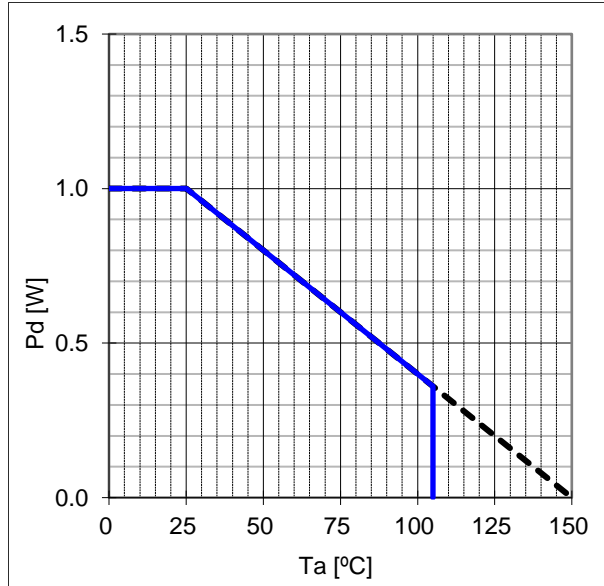

Figure 13. DIP7K Thermal Abatement Characteristics

Absolute Maximum Ratings (Ta = 25 °C)

Item	Symbol	Rating	Unit	Conditions
Maximum Applied Voltage 1	V _{MAX1}	-0.3 to +32.0	V	VCC pin voltage
Maximum Applied Voltage 2	V _{MAX2}	-0.3 to +6.5	V	SOURCE, FB, BR pin voltage
Maximum Applied Voltage 3	V _{MAX3}	650	V	DRAIN pin voltage
		730	V	DRAIN pin voltage (tpulse < 10 μs) (Note 2)
DRAIN Pin Current 1 (Pulse)	IDP1	12	A	P _W = 10 μs, Duty cycle = 1 % (BM2P10x1J-Z)
DRAIN Pin Current 2 (Pulse)	IDP2	4	A	P _W = 10 μs, Duty cycle = 1 % (BM2P10x3J-Z)
Power Dissipation	Pd	1.00	W	(Note 3)
Maximum Junction Temperature	Tjmax	150	°C	
Storage Temperature Range	Tstg	-55 to +150	°C	

Caution 1: Operating the IC over the absolute maximum ratings may damage the IC. The damage can either be a short circuit between pins or an open circuit between pins and the internal circuitry. Therefore, it is important to consider circuit protection measures, such as adding a fuse, in case the IC is operated over the absolute maximum ratings.

Caution 2: Should by any chance the maximum junction temperature rating be exceeded the rise in temperature of the chip may result in deterioration of the properties of the chip. In case of exceeding this absolute maximum rating, design a PCB with power dissipation taken into consideration by increasing board size and copper area so as not to exceed the maximum junction temperature rating.

(Note 2) Duty is less than 1 %.

(Note 3) At mounted on a glass epoxy single layer PCB (74.2 mm x 74.2 mm, 1.6 mm). Derate by 8 mW/°C if the IC is used in the ambient temperature Ta = 25 °C or above.

Recommended Operating Conditions

Item	Symbol	Min	Typ	Max	Unit	Conditions
Power Supply voltage Range 1	V _{CC}	8.9	-	26.0	V	VCC pin voltage
Power Supply voltage Range 2	V _{DRAIN}	-	-	650	V	DRAIN pin voltage
		-	-	730	V	DRAIN pin voltage (tpulse < 10 μs) (Note 4)
Operating Temperature	Topr	-40	-	+105	°C	

(Note 4) Duty is less than 1 %.

Electrical Characteristics

(Unless otherwise noted, Tj = -40 °C to +105 °C, VCC = 15 V)

Item	Symbol	Min	Typ	Max	Unit	Conditions
[MOSFET Part]						
Voltage between the DRAIN and SOURCE Pins	V _{(BR)DDS}	650	-	-	V	ID = 1 mA, VGS = 0 V
DRAIN Pin Leakage Current	IDSS	-	-	100	μA	VDS = 650 V, VGS = 0 V
On Resistance 1	R _{DS(ON)1}	-	1.0	1.4	Ω	ID = 0.25 A, VGS = 10 V (BM2P10x1J-Z)
On Resistance 2	R _{DS(ON)2}	-	3.0	3.6	Ω	ID = 0.25 A, VGS = 10 V (BM2P10x3J-Z)

Electrical Characteristics – continued

(Unless otherwise noted, T_j = -40 °C to +105 °C, V_{CC} = 15 V)

Item	Symbol	Min	Typ	Max	Unit	Conditions
[Circuit current]						
Circuit Current (ON) 1A	I _{ON1A}	-	900	1450	μA	V _{FB} = 2.4 V (in PULSE operation) (BM2P10x1J-Z) (Note 5)
Circuit Current (ON) 1B	I _{ON1B}	-	650	1050	μA	V _{FB} = 2.4 V (in PULSE operation) (BM2P10x3J-Z) (Note 5)
Circuit Current (ON) 2	I _{ON2}	150	300	450	μA	V _{FB} = 0.7 V (Note 5)
[VCC Pin Protective Function]						
VCC UVLO Voltage 1	V _{UVLO1}	12.5	13.5	14.5	V	At VCC pin voltage rising (Note 5)
VCC UVLO Voltage 2	V _{UVLO2}	7.5	8.2	8.9	V	At VCC pin voltage falling (Note 5)
VCC UVLO Hysteresis	V _{UVLO3}	-	5.3	-	V	V _{UVLO3} = V _{UVLO1} - V _{UVLO2} (Note 5)
VCC OVP Voltage 1	V _{OVP1}	26.0	27.5	29.0	V	At VCC pin voltage rising (Note 5)
VCC OVP Voltage 2	V _{OVP2}	22.0	23.5	25.0	V	At VCC pin voltage falling (Note 5)
VCC OVP Hysteresis	V _{OVP3}	-	4	-	V	V _{OVP3} = V _{OVP1} - V _{OVP2} (Note 5)
VCC Recharge Start Voltage	V _{CHG1}	7.7	8.7	9.7	V	
VCC Recharge Stop Voltage	V _{CHG2}	12.0	13.0	14.0	V	
Protection-mask Duration	t _{PROT}	-	90	-	μs	(Note 5)
TSD Temperature 1	T _{SD1}	135	160	185	°C	When the control IC part temperature rises
TSD Temperature 2	T _{SD2}	105	130	155	°C	When the control IC part temperature falls
[PWM-type DC/DC Driver Block]						
Oscillation Frequency 1	f _{SW1}	94	100	106	kHz	V _{FB} = 2.4 V (Note 5)
Oscillation Frequency 2	f _{SW2}	20	25	30	kHz	V _{FB} = 1.2 V (Note 5)
Frequency Hopping Width 1	f _{DEL1}	-	8	-	kHz	V _{FB} = 2.4 V (Note 5)
Soft Start Time 1	t _{SS1}	0.6	1.0	1.4	ms	
Soft Start Time 2	t _{SS2}	2.4	4.0	5.6	ms	
Max DUTY	D _{MAX}	70	80	90	%	
Minimum ON Width	t _{MIN}	150	400	650	ns	
FB Pin Pull-up Resistor	R _{FB}	23	30	37	kΩ	
ΔFB/ΔSOURCE Gain	Gain	-	3	-	V/V	(Note 5)
FB Burst Voltage 1	V _{BST1}	0.95	1.05	1.15	V	At FB pin voltage falling
FB Burst Voltage 2	V _{BST2}	1.00	1.10	1.20	V	At FB pin voltage rising
FB Burst Hysteresis	V _{BST3}	-	0.05	-	V	V _{BST3} = V _{BST2} - V _{BST1}
FB Voltage Stopping Frequency Reduction	V _{DLT1}	1.20	1.40	1.60	V	(Note 5)
FB Voltage Starting Frequency Reduction	V _{DLT2}	1.55	1.80	2.05	V	(Note 5)
FB OLP Voltage 1	V _{FOLP1}	3.3	3.5	3.7	V	Overload detected (at FB pin voltage rising) (Note 5)
FB OLP Voltage 2	V _{FOLP2}	3.1	3.3	3.5	V	Overload release (at FB pin voltage falling) (Note 5)
FB OLP ON Detection Timer	t _{FOLP1}	40	64	88	ms	
FB OLP OFF Timer	t _{FOLP2}	332	512	692	ms	

(Note 5) T_j = 25 °C warranty.

Electrical Characteristics – continued

(Unless otherwise noted, Tj = -40 °C to +105 °C, VCC = 15 V)

Item	Symbol	Min	Typ	Max	Unit	Conditions
[Overcurrent Detection Block]						
Over Current Detection Voltage 1	V _{OCP1}	0.735	0.780	0.825	V	Lower limit of over current detection voltage (Note 5)
Over Current Detection Voltage 2	V _{OCP2}	0.896	0.950	1.004	V	Upper limit of over current detection voltage (Note 5)
Over Current Detection Voltage SS1	V _{OCP SS1}	0.095	0.200	0.305	V	0 ms to t _{SS1}
Over Current Detection Voltage SS2	V _{OCP SS2}	0.290	0.395	0.500	V	t _{SS1} to t _{SS2}
Dynamic Over Current Detection Voltage	V _{DOC}	1.130	1.230	1.330	V	Lower limit of over current detection voltage
Leading Edge Blanking Time	t _{LEB}	120	250	380	ns	(Note 6)
[Startup Circuit Block]						
Startup Current 1	I _{START1}	0.1	0.3	1.0	mA	VCC = 0 V (Note 6)
Startup Current 2	I _{START2}	1.0	3.0	6.0	mA	VCC = 10 V (Note 5)
OFF Current	I _{START3}	-	10	25	μA	The inrush current from the DRAIN pin after releasing UVLO. (at MOSFET OFF)
Startup Circuit Response Voltage	V _{START}	-	17	-	V	Required for VCC UVLO cancellation DRAIN pin voltage (Note 5)
Startup Current Switching Voltage	V _{SC}	0.7	1.1	1.5	V	(Note 5)
VH UVLO Detection Voltage	V _{INLVP1}	0.7	0.8	0.9	V	At BR pin voltage falling
VH UVLO Release Voltage	V _{INLVP2}	0.8	0.9	1.0	V	At BR pin voltage rising
VH UVLO Timer	t _{INLVP}	40	64	88	ms	(Note 5)
VH OVP Detection Voltage	V _{INOVP1}	3.40	3.55	3.70	V	BM2P10BxJ-Z only (Note 5)
VH OVP Release Voltage	V _{INOVP2}	3.30	3.45	3.60	V	BM2P10BxJ-Z only (Note 5)
VH OVP Timer	t _{INOVP}	-	90	-	μs	(Note 5)
BR MASK Voltage	V _{BRMASK}	-	0.1	-	V	

(Note 5) Tj = 25 °C warranty.

(Note 6) Measurements are not made.

I/O Equivalence Circuit

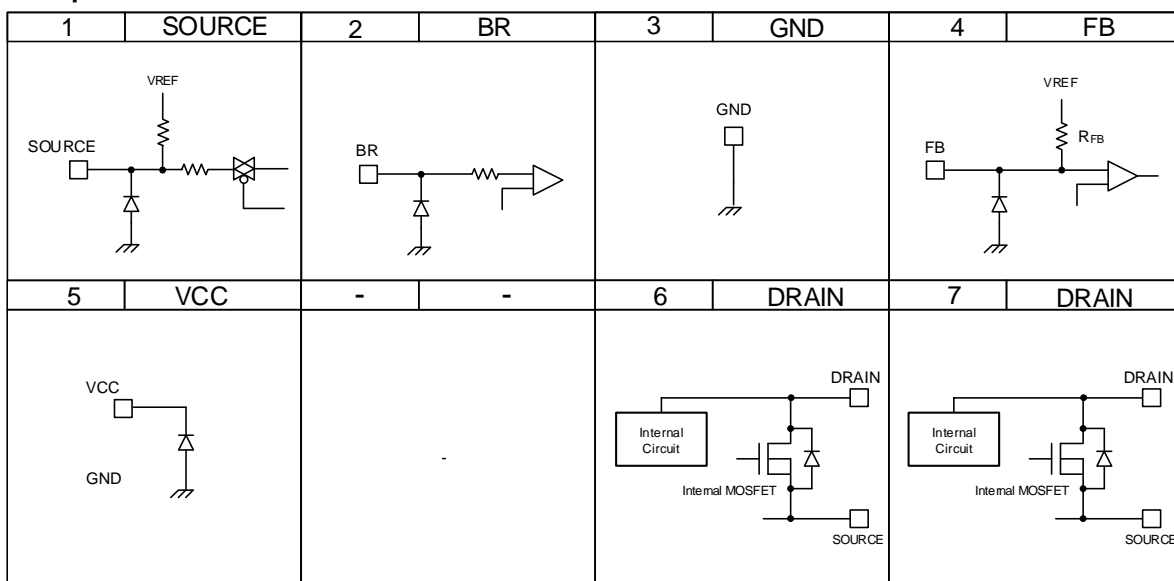

Application Example

A sample flyback circuit is shown in Figure 14.

Note that DRAIN pin voltage generates high voltage due to ringing etc. when the turn is OFF. This IC can operate up to 730 V.

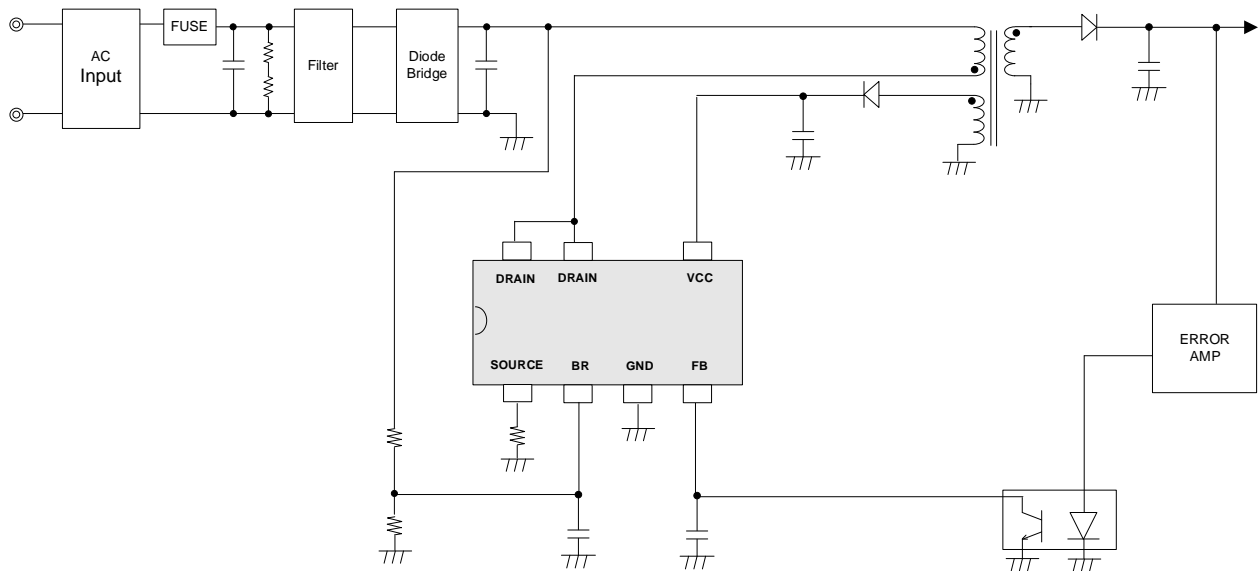

Figure 14. Flyback Application Diagram

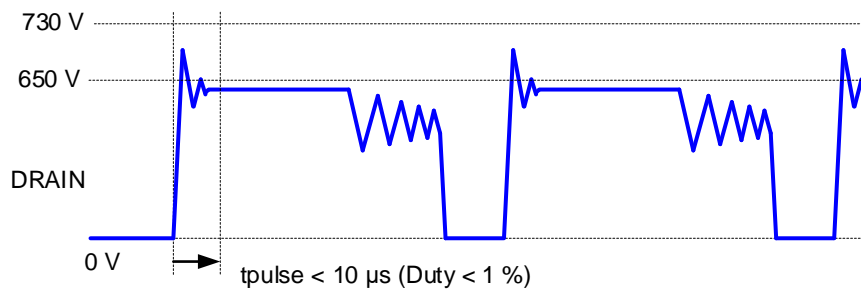

Figure 15. DRAIN pin Ringing Waveform

Typical Performance Curves (Reference Data)

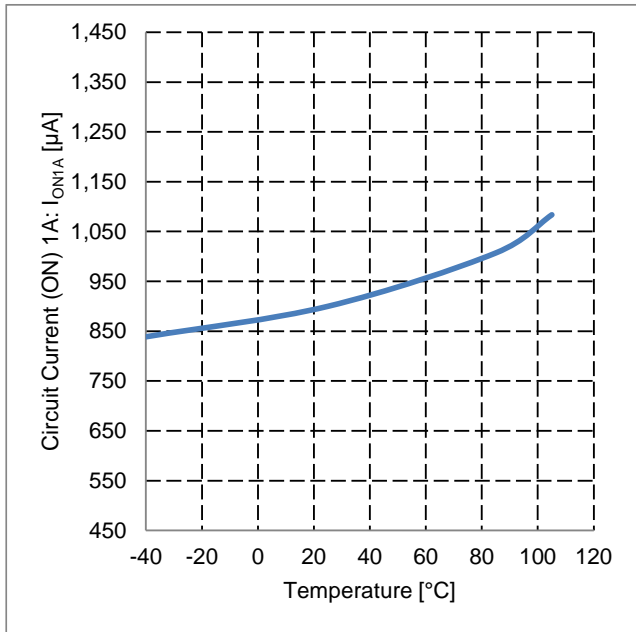

Figure 16. Circuit Current (ON) 1A vs Temperature

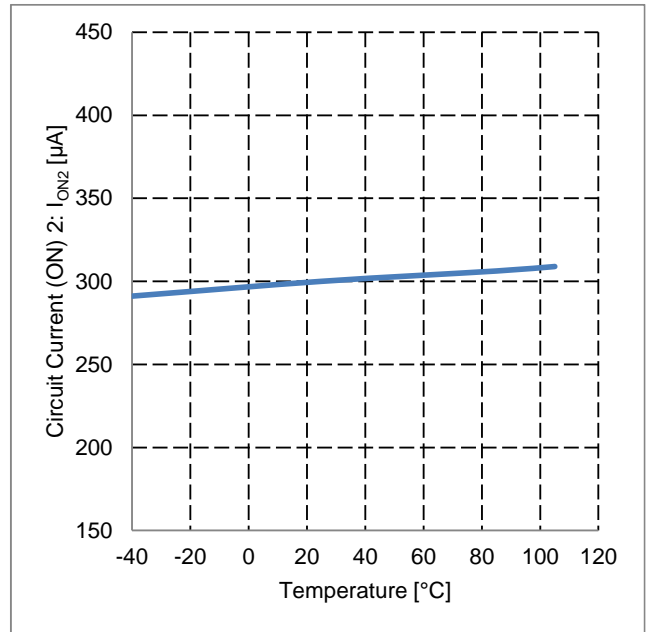

Figure 17. Circuit Current (ON) 2 vs Temperature

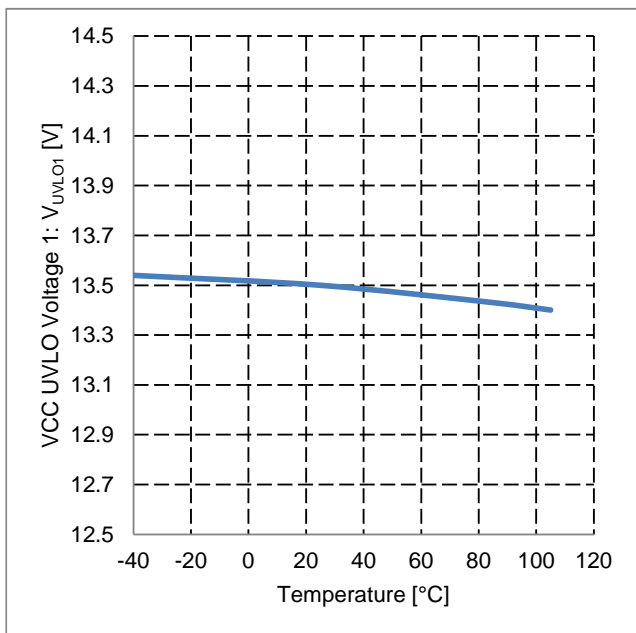

Figure 18. VCC UVLO Voltage 1 vs Temperature

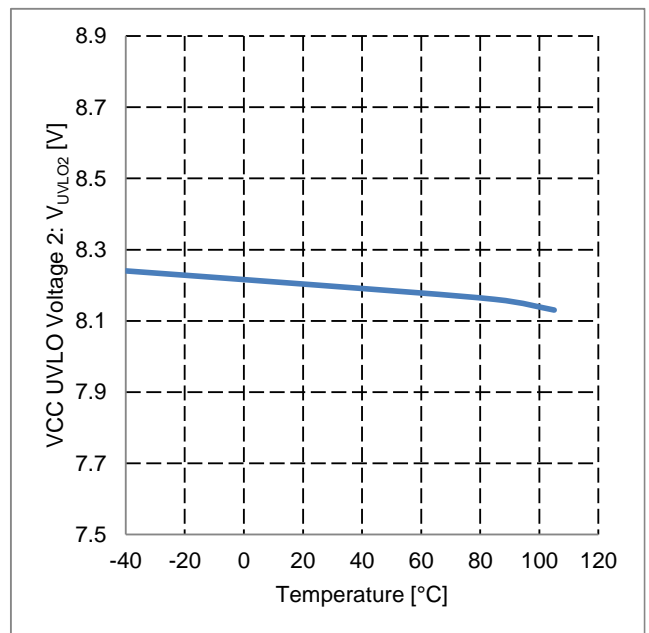

Figure 19. VCC UVLO Voltage 2 vs Temperature

Typical Performance Curves (Reference Data) - continued

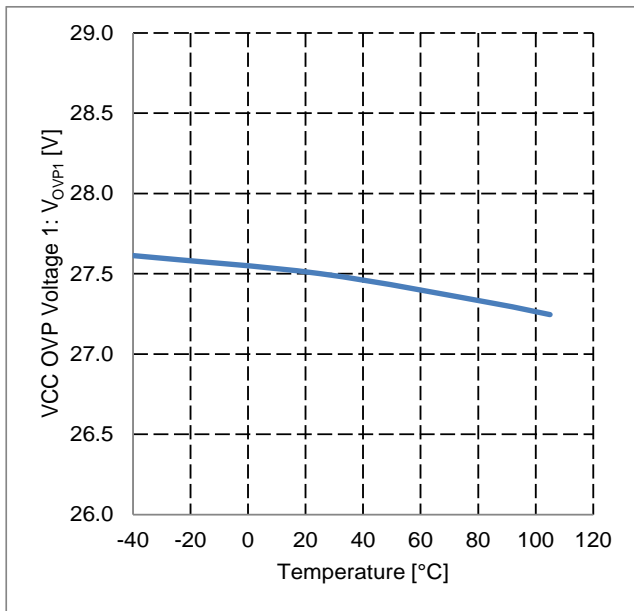

Figure 20. VCC OVP Voltage 1 vs Temperature

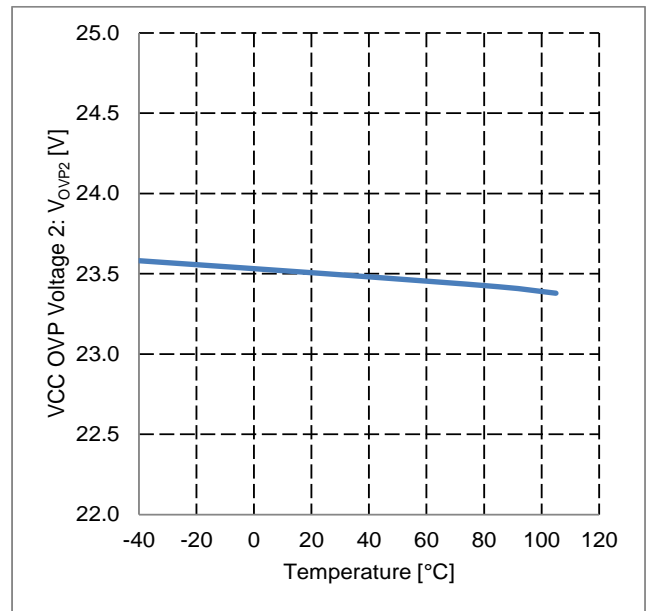

Figure 21. VCC OVP Voltage 2 vs Temperature

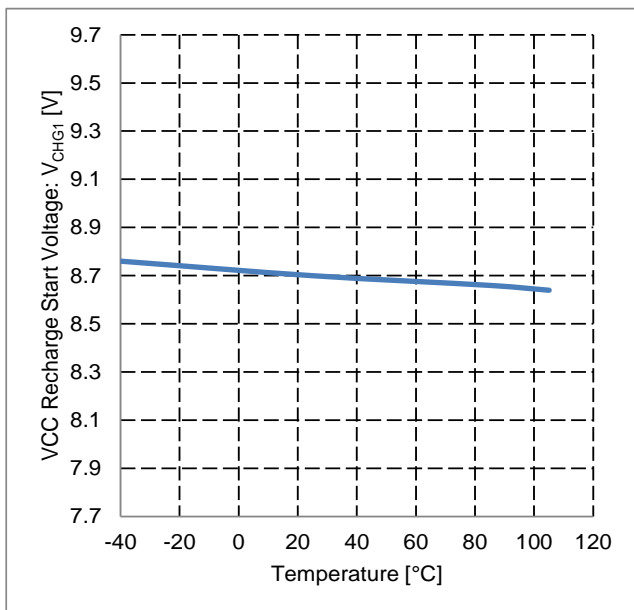

Figure 22. VCC Recharge Start Voltage vs Temperature

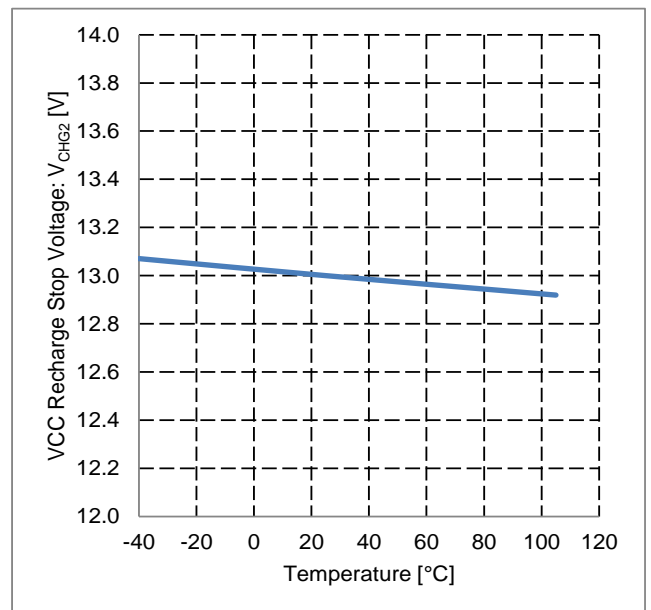

Figure 23. VCC Recharge Stop Voltage vs Temperature

Typical Performance Curves (Reference Data) - continued

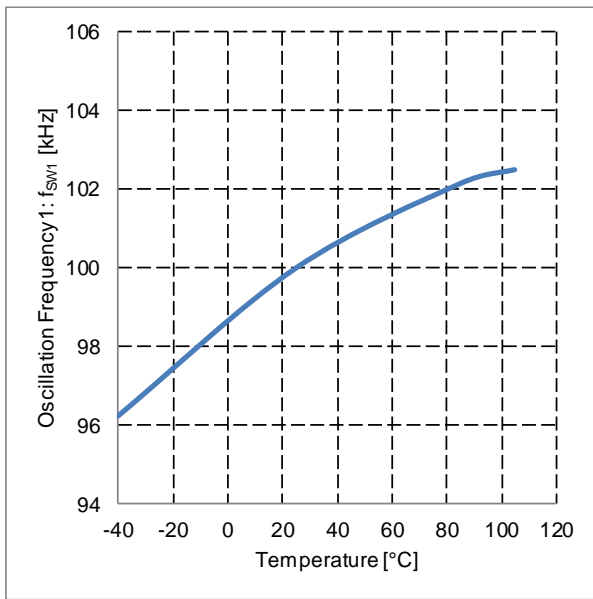

Figure 24. Oscillation Frequency 1 vs Temperature

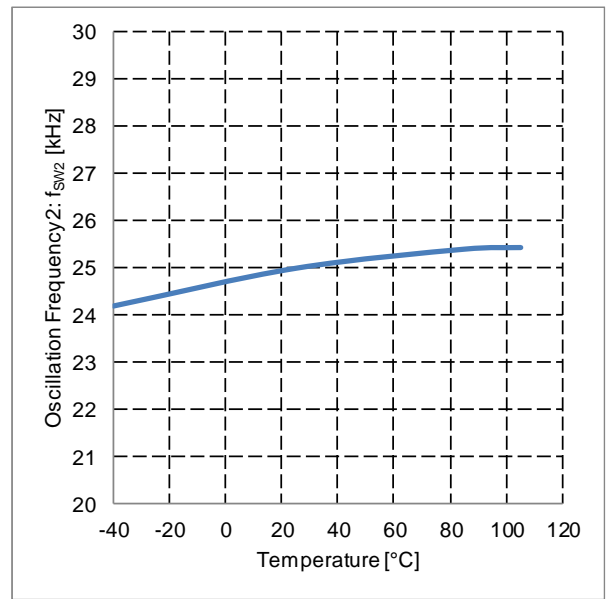

Figure 25. Oscillation Frequency 2 vs Temperature

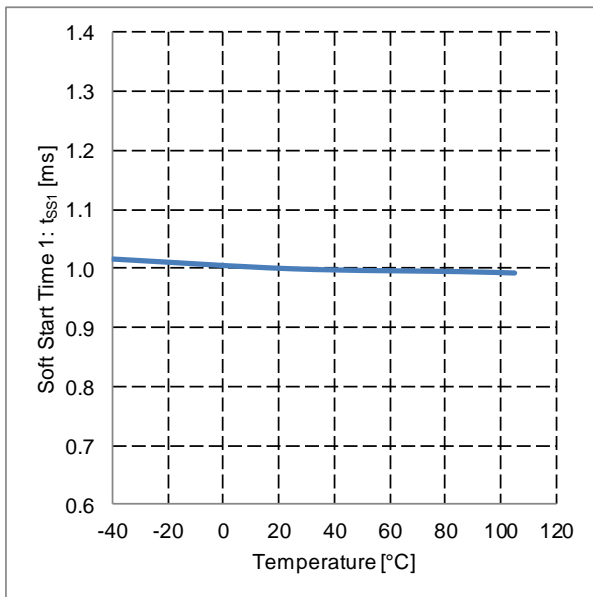

Figure 26. Soft Start Time 1 vs Temperature

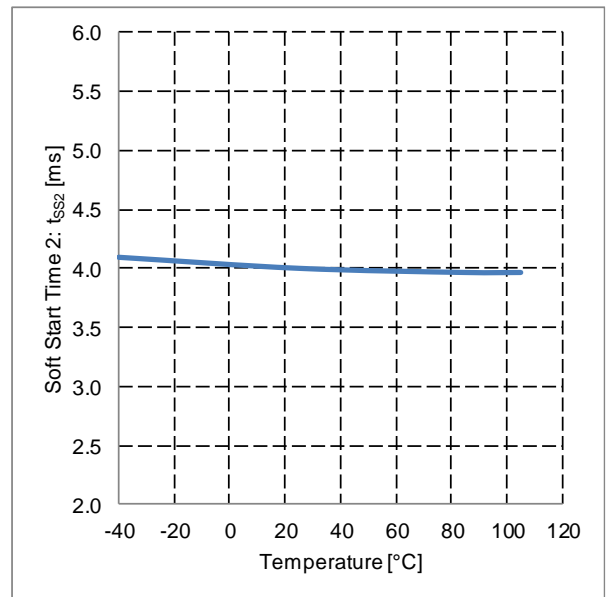

Figure 27. Soft Start Time 2 vs Temperature

Typical Performance Curves (Reference Data) - continued

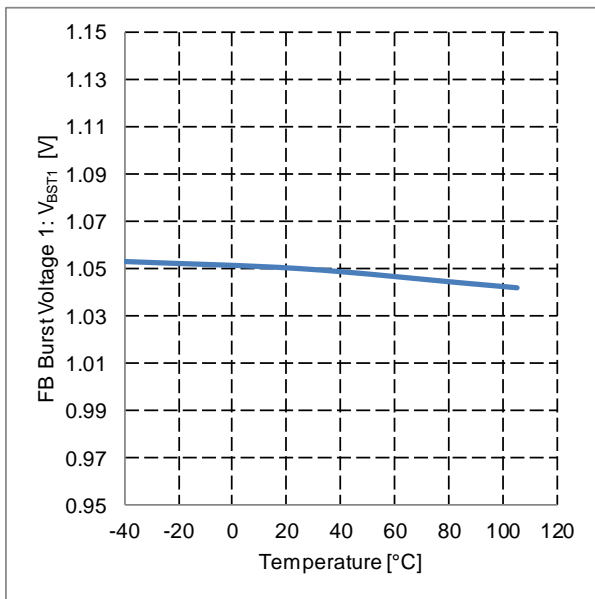

Figure 28. FB Burst Voltage 1 vs Temperature

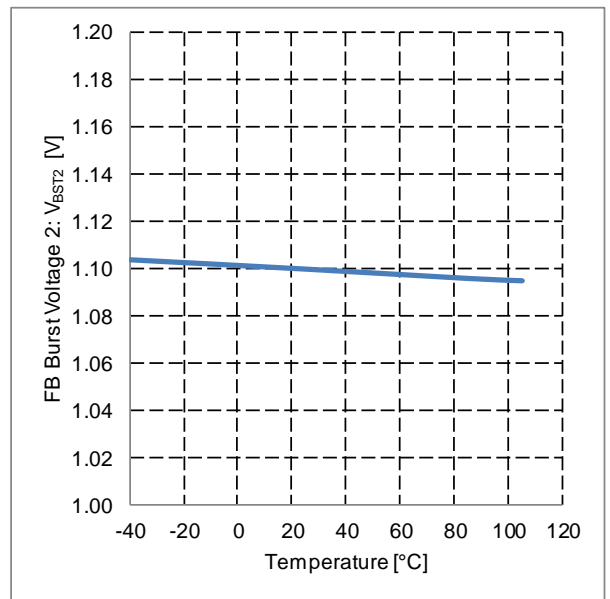

Figure 29. FB Burst Voltage 2 vs Temperature

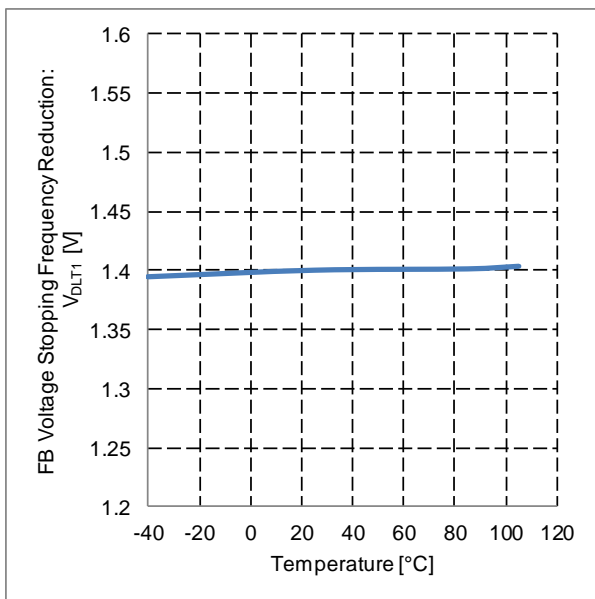

Figure 30. FB Voltage Stopping Frequency Reduction vs Temperature

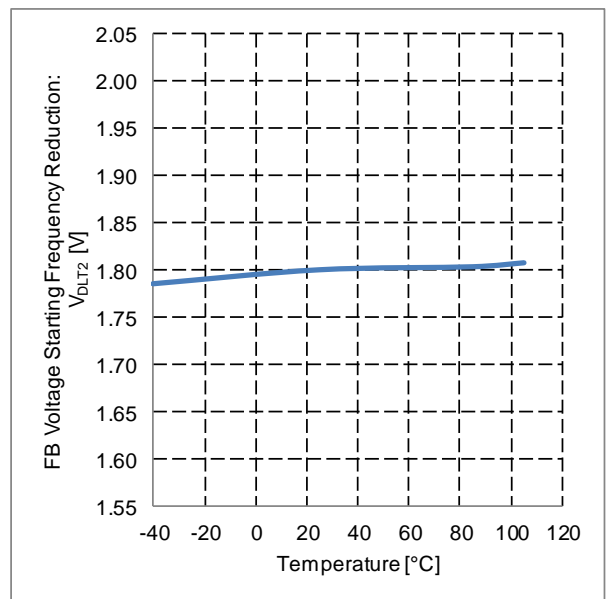

Figure 31. FB Voltage Starting Frequency Reduction vs Temperature

Typical Performance Curves (Reference Data) - continued

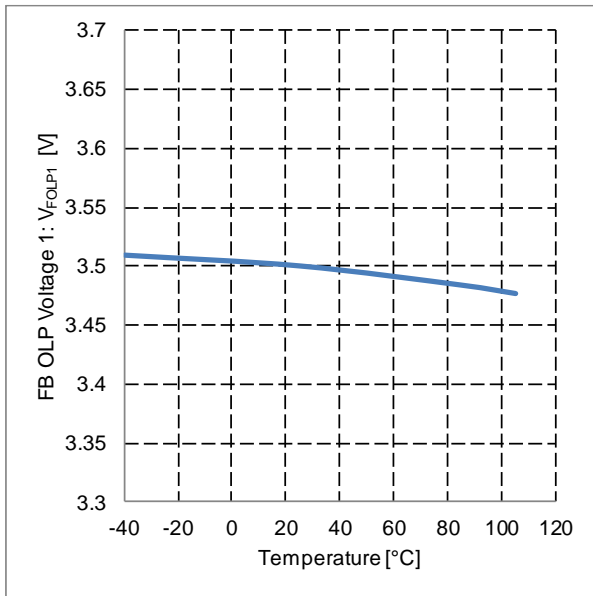

Figure 32. FB OLP Voltage 1 vs Temperature

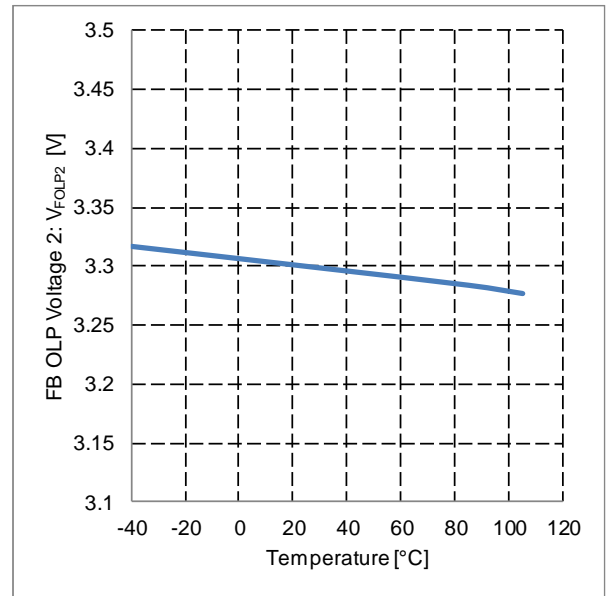

Figure 33. FB OLP Voltage 2 vs Temperature

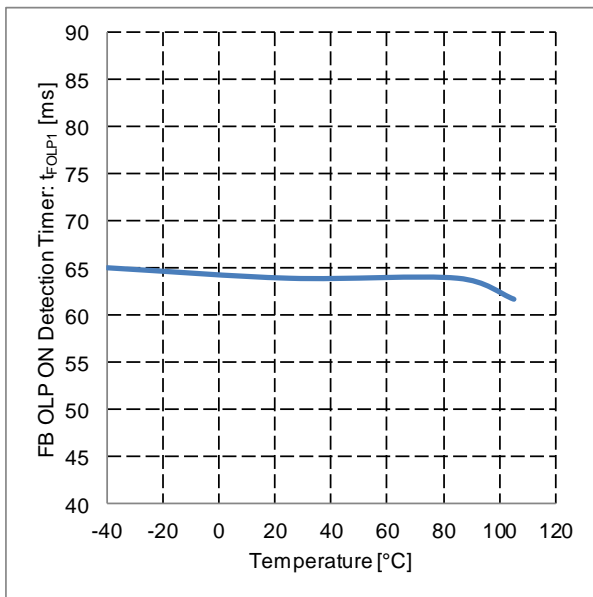

Figure 34. FB OLP ON Detection Timer vs Temperature

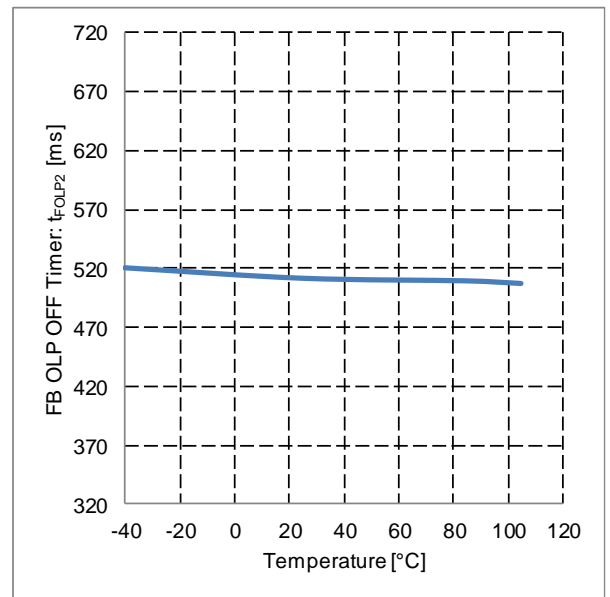

Figure 35. FB OLP OFF Timer vs Temperature

Typical Performance Curves (Reference Data) - continued

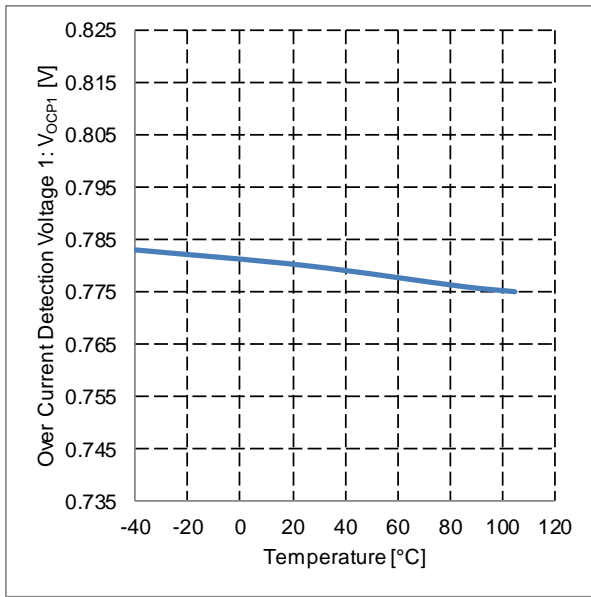

Figure 36. Over Current Detection Voltage 1 vs Temperature

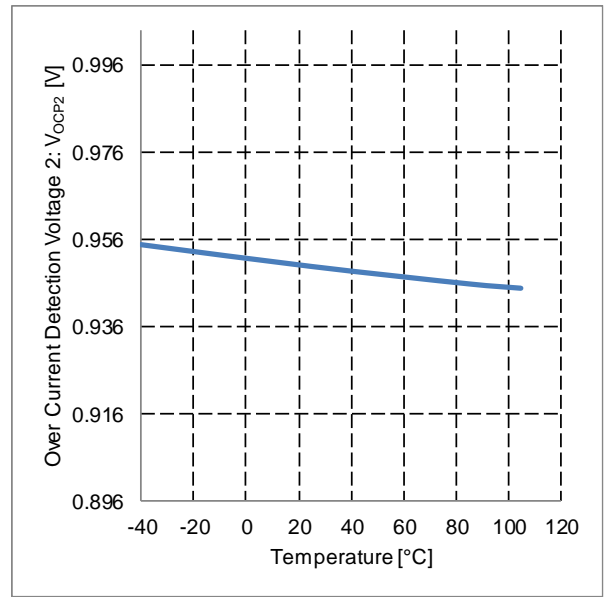

Figure 37. Over Current Detection Voltage 2 vs Temperature

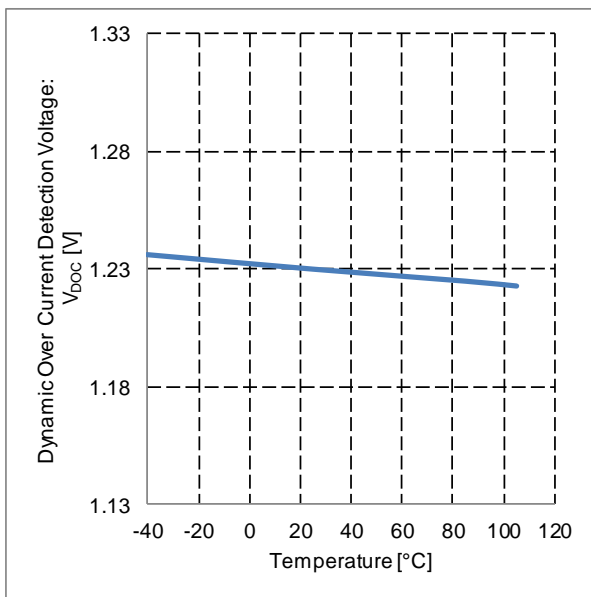

Figure 38. Dynamic Over Current Detection Voltage vs Temperature

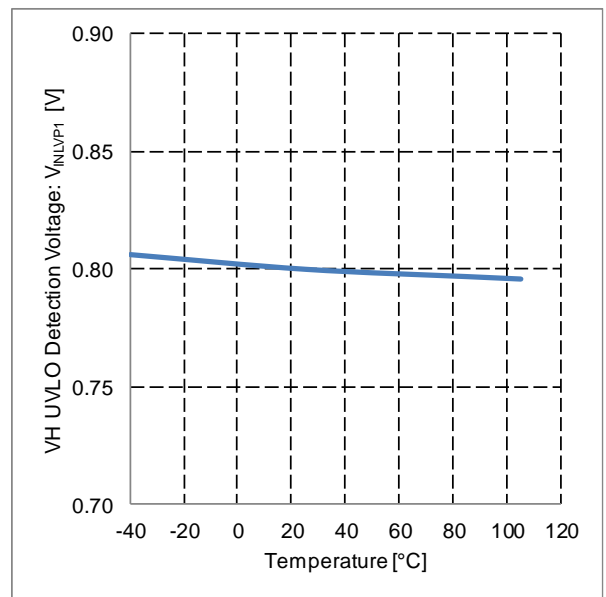

Figure 39. VH UVLO Detection Voltage vs Temperature

Typical Performance Curves (Reference Data) - continued

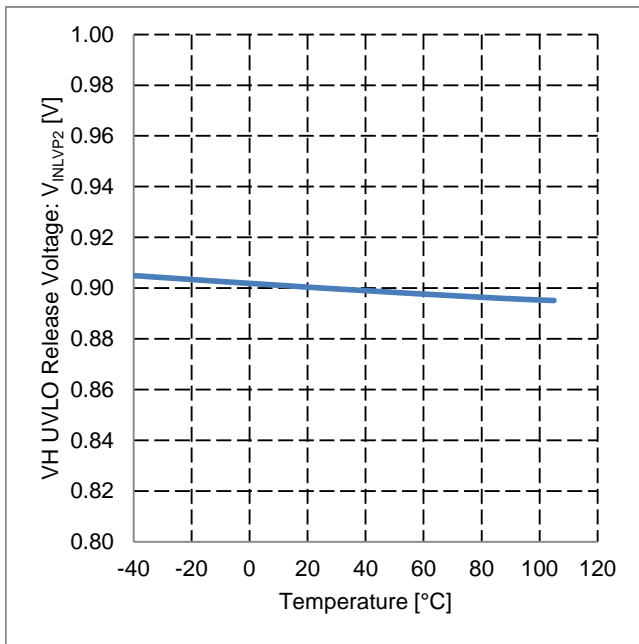

Figure 40. VH UVLO Release Voltage vs Temperature

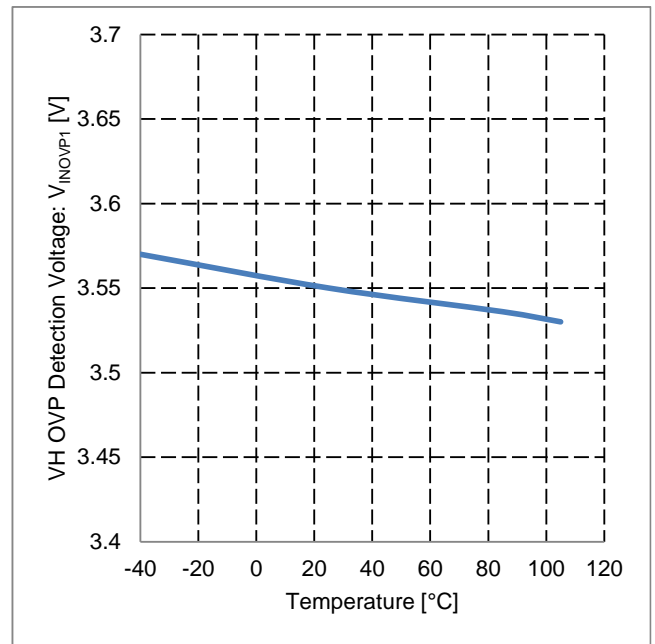

Figure 41. VH OVP Detection Voltage vs Temperature

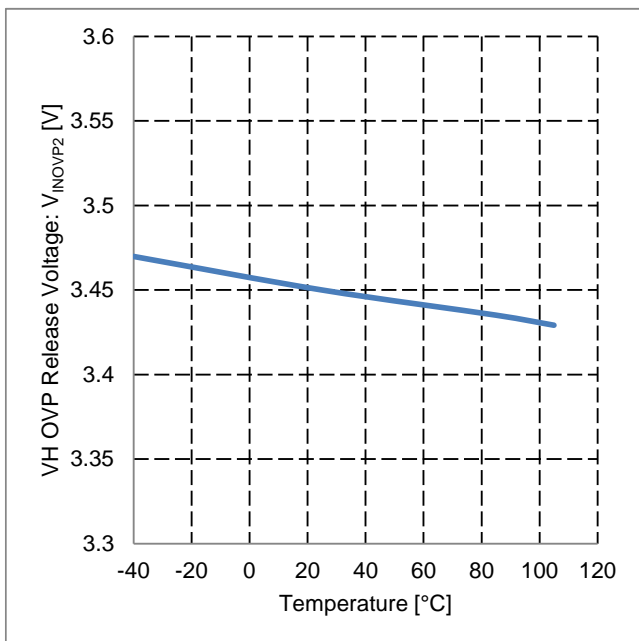

Figure 42. VH OVP Release Voltage vs Temperature

Operational Notes

1. Reverse Connection of Power Supply

Connecting the power supply in reverse polarity can damage the IC. Take precautions against reverse polarity when connecting the power supply, such as mounting an external diode between the power supply and the IC's power supply pins.

2. Power Supply Lines

Design the PCB layout pattern to provide low impedance supply lines. Separate the ground and supply lines of the digital and analog blocks to prevent noise in the ground and supply lines of the digital block from affecting the analog block. Furthermore, connect a capacitor to ground at all power supply pins. Consider the effect of temperature and aging on the capacitance value when using electrolytic capacitors.

3. Ground Voltage

Ensure that no pins are at a voltage below that of the ground pin at any time, even during transient condition.

4. Ground Wiring Pattern

When using both small-signal and large-current ground traces, the two ground traces should be routed separately but connected to a single ground at the reference point of the application board to avoid fluctuations in the small-signal ground caused by large currents. Also ensure that the ground traces of external components do not cause variations on the ground voltage. The ground lines must be as short and thick as possible to reduce line impedance.

5. Recommended Operating Conditions

The function and operation of the IC are guaranteed within the range specified by the recommended operating conditions. The characteristic values are guaranteed only under the conditions of each item specified by the electrical characteristics.

6. Inrush Current

When power is first supplied to the IC, it is possible that the internal logic may be unstable and inrush current may flow instantaneously due to the internal powering sequence and delays, especially if the IC has more than one power supply. Therefore, give special consideration to power coupling capacitance, power wiring, width of ground wiring, and routing of connections.

7. Testing on Application Boards

When testing the IC on an application board, connecting a capacitor directly to a low-impedance output pin may subject the IC to stress. Always discharge capacitors completely after each process or step. The IC's power supply should always be turned off completely before connecting or removing it from the test setup during the inspection process. To prevent damage from static discharge, ground the IC during assembly and use similar precautions during transport and storage.

8. Inter-pin Short and Mounting Errors

Ensure that the direction and position are correct when mounting the IC on the PCB. Incorrect mounting may result in damaging the IC. Avoid nearby pins being shorted to each other especially to ground, power supply and output pin. Inter-pin shorts could be due to many reasons such as metal particles, water droplets (in very humid environment) and unintentional solder bridge deposited in between pins during assembly to name a few.

9. Unused Input Pins

Input pins of an IC are often connected to the gate of a MOS transistor. The gate has extremely high impedance and extremely low capacitance. If left unconnected, the electric field from the outside can easily charge it. The small charge acquired in this way is enough to produce a significant effect on the conduction through the transistor and cause unexpected operation of the IC. So unless otherwise specified, unused input pins should be connected to the power supply or ground line.

Operational Notes – continued

10. Regarding the Input Pin of the IC

This IC contains P+ isolation and P substrate layers between adjacent elements in order to keep them isolated. P-N junctions are formed at the intersection of the P layers with the N layers of other elements, creating a parasitic diode or transistor. For example (refer to figure below):

When $GND > Pin\ A$ and $GND > Pin\ B$, the P-N junction operates as a parasitic diode.

When $GND > Pin\ B$, the P-N junction operates as a parasitic transistor.

Parasitic diodes inevitably occur in the structure of the IC. The operation of parasitic diodes can result in mutual interference among circuits, operational faults, or physical damage. Therefore, conditions that cause these diodes to operate, such as applying a voltage lower than the GND voltage to an input pin (and thus to the P substrate) should be avoided

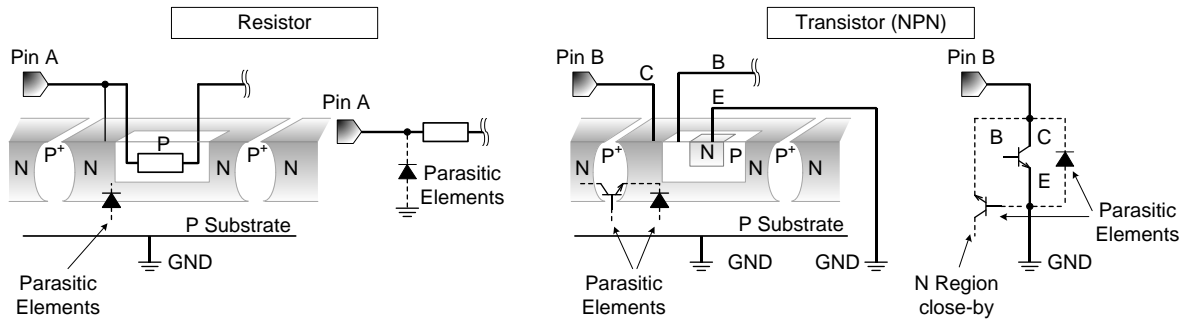

Figure 43. Example of IC Structure

11. Ceramic Capacitor

When using a ceramic capacitor, determine a capacitance value considering the change of capacitance with temperature and the decrease in nominal capacitance due to DC bias and others.

12. Thermal Shutdown Circuit (TSD)

This IC has a built-in thermal shutdown circuit that prevents heat damage to the IC. Normal operation should always be within the IC's maximum junction temperature rating. If however the rating is exceeded for a continued period, the junction temperature (T_j) will rise which will activate the TSD circuit that will turn OFF power output pins. When the T_j falls below the TSD threshold, the circuits are automatically restored to normal operation.

Note that the TSD circuit operates in a situation that exceeds the absolute maximum ratings and therefore, under no circumstances, should the TSD circuit be used in a set design or for any purpose other than protecting the IC from heat damage.

13. Over Current Protection Circuit (OCP)

This IC incorporates an integrated over current protection circuit that is activated when the load is shorted. This protection circuit is effective in preventing damage due to sudden and unexpected incidents. However, the IC should not be used in applications characterized by continuous operation or transitioning of the protection circuit.

Ordering Information

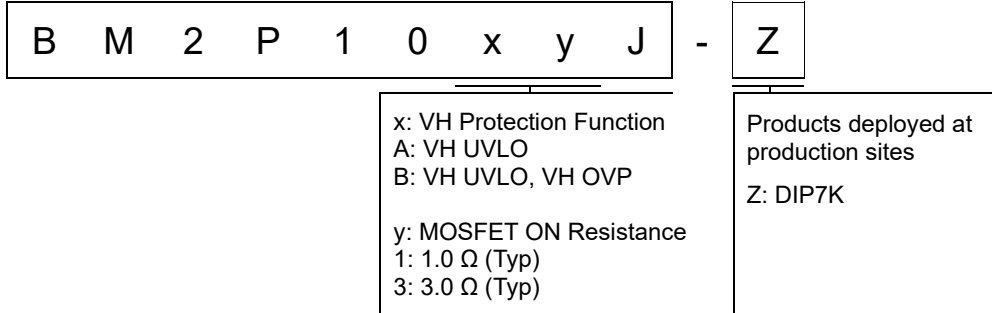

Marking Diagram

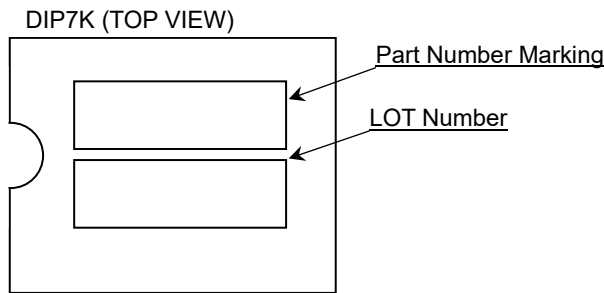

Part Number Marking	Product Name	MOSFET ON Resistance	VH UVLO	VH OVP
BM2P10A1J	BM2P10A1J-Z	1.0 Ω (Typ)	○	-
BM2P10A3J	BM2P10A3J-Z	3.0 Ω (Typ)	○	-
BM2P10B1J	BM2P10B1J-Z	1.0 Ω (Typ)	○	○
BM2P10B3J	BM2P10B3J-Z	3.0 Ω (Typ)	○	○

Physical Dimension and Packing Information

Package Name	DIP7K
--------------	-------

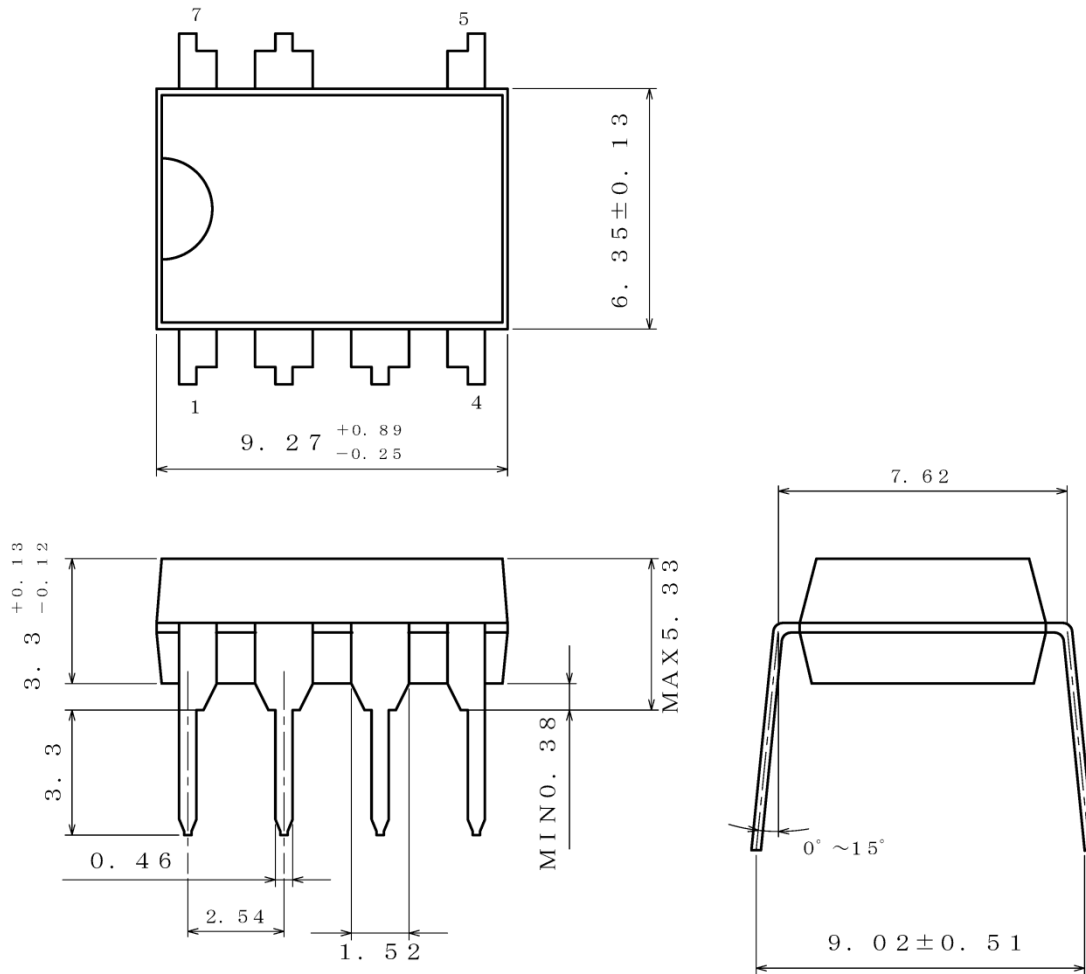

(UNIT : mm)
 PKG : DIP7K
 Drawing No. EX001-0076

< Container Information >

Container	Tube
Quantity	2000pcs
Direction of feed	Packing orientation is same in tube

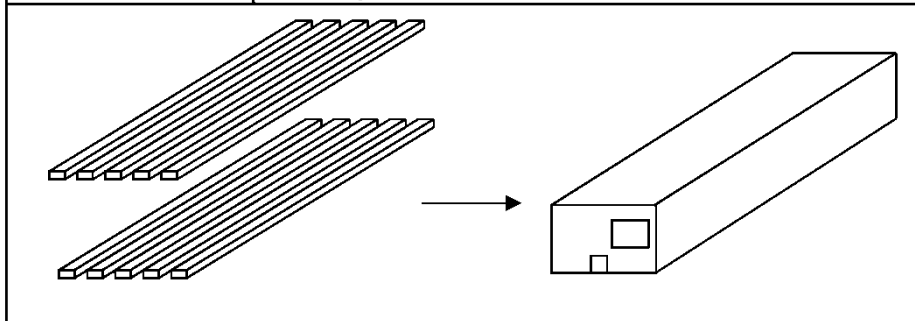

Revision History

Date	Revision	Changes
18.Apr.2022	001	New release
18.Jul.2022	002	Removed the word " under development " for BM2P10A1J-Z and BM2P10A3J-Z. p.1 Expanded applications. p.9 Added explanation of AC correction of over current detection function. Updated Figure 10. p.10 Added explanation of the soft start function. p.10 Added explanation of the dynamic over current detection function. p.15 Changed the description method of the conditions for electrical characteristics of over current detection voltage. p.15 Changed the description of Note 6.

Notice

Precaution on using ROHM Products

- Our Products are designed and manufactured for application in ordinary electronic equipment (such as AV equipment, OA equipment, telecommunication equipment, home electronic appliances, amusement equipment, etc.). If you intend to use our Products in devices requiring extremely high reliability (such as medical equipment ^(Note 1), transport equipment, traffic equipment, aircraft/spacecraft, nuclear power controllers, fuel controllers, car equipment including car accessories, safety devices, etc.) and whose malfunction or failure may cause loss of human life, bodily injury or serious damage to property ("Specific Applications"), please consult with the ROHM sales representative in advance. Unless otherwise agreed in writing by ROHM in advance, ROHM shall not be in any way responsible or liable for any damages, expenses or losses incurred by you or third parties arising from the use of any ROHM's Products for Specific Applications.

(Note1) Medical Equipment Classification of the Specific Applications

JAPAN	USA	EU	CHINA
CLASS III	CLASS III	CLASS II b	CLASS III
CLASS IV		CLASS III	

- ROHM designs and manufactures its Products subject to strict quality control system. However, semiconductor products can fail or malfunction at a certain rate. Please be sure to implement, at your own responsibilities, adequate safety measures including but not limited to fail-safe design against the physical injury, damage to any property, which a failure or malfunction of our Products may cause. The following are examples of safety measures:
 - Installation of protection circuits or other protective devices to improve system safety
 - Installation of redundant circuits to reduce the impact of single or multiple circuit failure
- Our Products are designed and manufactured for use under standard conditions and not under any special or extraordinary environments or conditions, as exemplified below. Accordingly, ROHM shall not be in any way responsible or liable for any damages, expenses or losses arising from the use of any ROHM's Products under any special or extraordinary environments or conditions. If you intend to use our Products under any special or extraordinary environments or conditions (as exemplified below), your independent verification and confirmation of product performance, reliability, etc. prior to use, must be necessary:
 - Use of our Products in any types of liquid, including water, oils, chemicals, and organic solvents
 - Use of our Products outdoors or in places where the Products are exposed to direct sunlight or dust
 - Use of our Products in places where the Products are exposed to sea wind or corrosive gases, including Cl₂, H₂S, NH₃, SO₂, and NO₂
 - Use of our Products in places where the Products are exposed to static electricity or electromagnetic waves
 - Use of our Products in proximity to heat-producing components, plastic cords, or other flammable items
 - Sealing or coating our Products with resin or other coating materials
 - Use of our Products without cleaning residue of flux (Exclude cases where no-clean type fluxes is used. However, recommend sufficiently about the residue.) ; or Washing our Products by using water or water-soluble cleaning agents for cleaning residue after soldering
 - Use of the Products in places subject to dew condensation
- The Products are not subject to radiation-proof design.
- Please verify and confirm characteristics of the final or mounted products in using the Products.
- In particular, if a transient load (a large amount of load applied in a short period of time, such as pulse, is applied, confirmation of performance characteristics after on-board mounting is strongly recommended. Avoid applying power exceeding normal rated power; exceeding the power rating under steady-state loading condition may negatively affect product performance and reliability.
- De-rate Power Dissipation depending on ambient temperature. When used in sealed area, confirm that it is the use in the range that does not exceed the maximum junction temperature.
- Confirm that operation temperature is within the specified range described in the product specification.
- ROHM shall not be in any way responsible or liable for failure induced under deviant condition from what is defined in this document.

Precaution for Mounting / Circuit board design

- When a highly active halogenous (chlorine, bromine, etc.) flux is used, the residue of flux may negatively affect product performance and reliability.
- In principle, the reflow soldering method must be used on a surface-mount products, the flow soldering method must be used on a through hole mount products. If the flow soldering method is preferred on a surface-mount products, please consult with the ROHM representative in advance.

For details, please refer to ROHM Mounting specification

Precautions Regarding Application Examples and External Circuits

1. If change is made to the constant of an external circuit, please allow a sufficient margin considering variations of the characteristics of the Products and external components, including transient characteristics, as well as static characteristics.
2. You agree that application notes, reference designs, and associated data and information contained in this document are presented only as guidance for Products use. Therefore, in case you use such information, you are solely responsible for it and you must exercise your own independent verification and judgment in the use of such information contained in this document. ROHM shall not be in any way responsible or liable for any damages, expenses or losses incurred by you or third parties arising from the use of such information.

Precaution for Electrostatic

This Product is electrostatic sensitive product, which may be damaged due to electrostatic discharge. Please take proper caution in your manufacturing process and storage so that voltage exceeding the Products maximum rating will not be applied to Products. Please take special care under dry condition (e.g. Grounding of human body / equipment / solder iron, isolation from charged objects, setting of Ionizer, friction prevention and temperature / humidity control).

Precaution for Storage / Transportation

1. Product performance and soldered connections may deteriorate if the Products are stored in the places where:
 - [a] the Products are exposed to sea winds or corrosive gases, including Cl₂, H₂S, NH₃, SO₂, and NO₂
 - [b] the temperature or humidity exceeds those recommended by ROHM
 - [c] the Products are exposed to direct sunshine or condensation
 - [d] the Products are exposed to high Electrostatic
2. Even under ROHM recommended storage condition, solderability of products out of recommended storage time period may be degraded. It is strongly recommended to confirm solderability before using Products of which storage time is exceeding the recommended storage time period.
3. Store / transport cartons in the correct direction, which is indicated on a carton with a symbol. Otherwise bent leads may occur due to excessive stress applied when dropping of a carton.
4. Use Products within the specified time after opening a humidity barrier bag. Baking is required before using Products of which storage time is exceeding the recommended storage time period.

Precaution for Product Label

A two-dimensional barcode printed on ROHM Products label is for ROHM's internal use only.

Precaution for Disposition

When disposing Products please dispose them properly using an authorized industry waste company.

Precaution for Foreign Exchange and Foreign Trade act

Since concerned goods might be fallen under listed items of export control prescribed by Foreign exchange and Foreign trade act, please consult with ROHM in case of export.

Precaution Regarding Intellectual Property Rights

1. All information and data including but not limited to application example contained in this document is for reference only. ROHM does not warrant that foregoing information or data will not infringe any intellectual property rights or any other rights of any third party regarding such information or data.
2. ROHM shall not have any obligations where the claims, actions or demands arising from the combination of the Products with other articles such as components, circuits, systems or external equipment (including software).
3. No license, expressly or implied, is granted hereby under any intellectual property rights or other rights of ROHM or any third parties with respect to the Products or the information contained in this document. Provided, however, that ROHM will not assert its intellectual property rights or other rights against you or your customers to the extent necessary to manufacture or sell products containing the Products, subject to the terms and conditions herein.

Other Precaution

1. This document may not be reprinted or reproduced, in whole or in part, without prior written consent of ROHM.
2. The Products may not be disassembled, converted, modified, reproduced or otherwise changed without prior written consent of ROHM.
3. In no event shall you use in any way whatsoever the Products and the related technical information contained in the Products or this document for any military purposes, including but not limited to, the development of mass-destruction weapons.
4. The proper names of companies or products described in this document are trademarks or registered trademarks of ROHM, its affiliated companies or third parties.

General Precaution

1. Before you use our Products, you are requested to carefully read this document and fully understand its contents. ROHM shall not be in any way responsible or liable for failure, malfunction or accident arising from the use of any ROHM's Products against warning, caution or note contained in this document.
2. All information contained in this document is current as of the issuing date and subject to change without any prior notice. Before purchasing or using ROHM's Products, please confirm the latest information with a ROHM sales representative.
3. The information contained in this document is provided on an "as is" basis and ROHM does not warrant that all information contained in this document is accurate and/or error-free. ROHM shall not be in any way responsible or liable for any damages, expenses or losses incurred by you or third parties resulting from inaccuracy or errors of or concerning such information.