

Comparator for Automotive

Rail-to-Rail Input Push-Pull Output Low Supply Current CMOS Comparator

BU7232YFVM-C

General Description

BU7232YFVM-C is Rail-to-Rail input, Push-Pull output, dual comparators. It has a wide operating temperature range. It features low operating supply voltage from 1.8 V to 5.5 V, low supply current and extremely low input bias current.

Features

- AEC-Q100 Qualified^(Note 1)
 - Rail-to-Rail Input
 - Push-Pull Output
- (Note 1) Grade 1*

Applications

- Voltage Detection Equipment
- Automotive Electronics Equipment

Pin Configuration

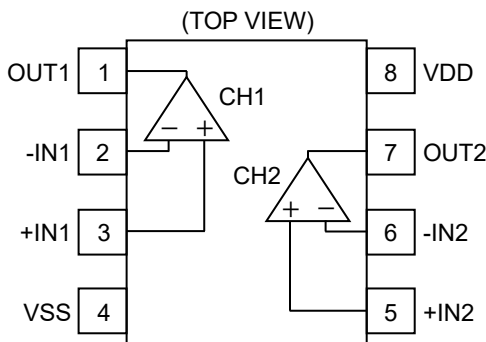

Key Specifications

- Operating Supply Voltage Range:
 - Single Supply 1.8 V to 5.5 V
 - Dual Supply ± 0.90 V to ± 2.75 V
- Temperature Range: -40 °C to +125 °C
- Supply Current: 10 μ A(Typ)
- Input Bias Current: 1 pA(Typ)

Special Characteristic

- Input Offset Voltage -40 °C to +125 °C: 15 mV(Max)

Package

MSOP8

W(Typ) x D(Typ) x H(Max)
2.90 mm x 4.00 mm x 0.90 mm



Pin Descriptions

Pin No.	Pin Name	Function
1	OUT1	Output 1
2	-IN1	Inverting input 1
3	+IN1	Non-inverting input 1
4	VSS	Ground/Negative power supply
5	+IN2	Non-inverting input 2
6	-IN2	Inverting input 2
7	OUT2	Output 2
8	VDD	Positive power supply

Block Diagram

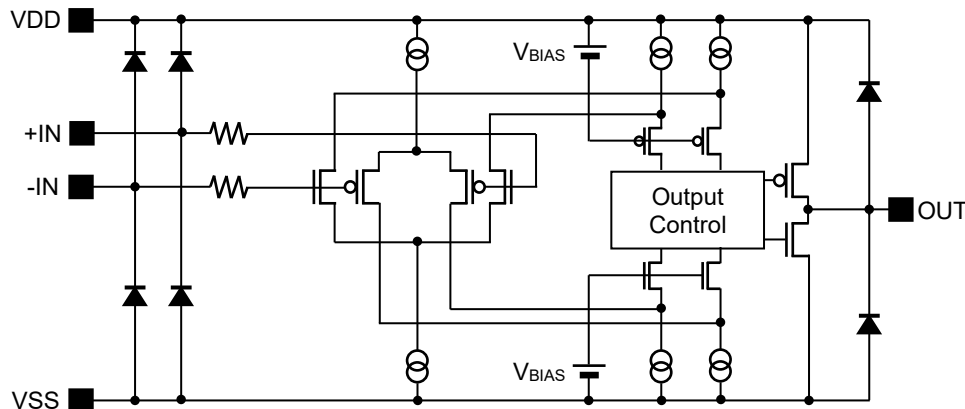

Block Diagram (One channel only)

○Product structure : Silicon monolithic integrated circuit ○This product has no designed protection against radioactive rays

Absolute Maximum Ratings (Ta=25 °C)

Parameter	Symbol	Rating	Unit
Supply Voltage	V _{DD} -V _{SS}	7	V
Differential Input Voltage ^(Note 1)	V _{ID}	V _{DD} - V _{SS}	V
Common-mode Input Voltage Range	V _{ICM}	(V _{SS} - 0.3) to (V _{DD} + 0.3)	V
Input Current	I _I	±10	mA
Storage Temperature Range	T _{stg}	-55 to +150	°C
Maximum Junction Temperature	T _{jmax}	150	°C

Caution 1: Operating the IC over the absolute maximum ratings may damage the IC. The damage can either be a short circuit between pins or an open circuit between pins and the internal circuitry. Therefore, it is important to consider circuit protection measures, such as adding a fuse, in case the IC is operated over the absolute maximum ratings.

Caution 2: Should by any chance the maximum junction temperature rating be exceeded the rise in temperature of the chip may result in deterioration of the properties of the chip. In case of exceeding this absolute maximum rating, design a PCB with thermal resistance taken into consideration by increasing board size and copper area so as not to exceed the maximum junction temperature rating.

(Note 1) The differential input voltage indicates the voltage difference between inverting input and non-inverting input.
The input pin voltage is set to more than V_{SS}.

Thermal Resistance^(Note 1)

Parameter	Symbol	Thermal Resistance (Typ)		Unit
		1s ^(Note 3)	2s2p ^(Note 4)	
MSOP8				
Junction to Ambient	θ _{JA}	284.1	135.4	°C/W
Junction to Top Characterization Parameter ^(Note 2)	Ψ _{JT}	21	11	°C/W

(Note 1) Based on JESD51-2A(Still-Air).

(Note 2) The thermal characterization parameter to report the difference between junction temperature and the temperature at the top center of the outside surface of the component package.

(Note 3) Using a PCB board based on JESD51-3.

(Note 4) Using a PCB board based on JESD51-7.

Layer Number of Measurement Board	Material	Board Size
Single	FR-4	114.3 mm x 76.2 mm x 1.57 mmt

Top	
Copper Pattern	Thickness
Footprints and Traces	70 μm

Layer Number of Measurement Board	Material	Board Size
4 Layers	FR-4	114.3 mm x 76.2 mm x 1.6 mmt

Top		2 Internal Layers		Bottom	
Copper Pattern	Thickness	Copper Pattern	Thickness	Copper Pattern	Thickness
Footprints and Traces	70 μm	74.2 mm x 74.2 mm	35 μm	74.2 mm x 74.2 mm	70 μm

Recommended Operating Conditions

Parameter	Symbol	Min	Typ	Max	Unit
Operating Supply Voltage	V _{opr}	1.8 ±0.90	3.0 ±1.50	5.5 ±2.75	V
Operating Temperature	T _{opr}	-40	+25	+125	°C

Electrical Characteristics (Unless otherwise specified $V_{DD}=3.0\text{ V}$, $V_{SS}=0.0\text{ V}$, $T_a=25\text{ }^\circ\text{C}$)

Parameter	Symbol	Temperature Range	Limit			Unit	Conditions
			Min	Typ	Max		
Input Offset Voltage ^(Note 1,2)	V_{IO}	25 °C	-	1	14	mV	-
		Full range	-	-	15		
Input Offset Current ^(Note 1)	I_{IO}	25 °C	-	1	-	pA	-
Input Bias Current ^(Note 1,2)	I_B	25 °C	-	1	-	pA	-
Supply Current ^(Note 2)	I_{DD}	25 °C	-	10	25	μA	$R_L=\infty$, All comparators
		Full range	-	-	50		
Output Voltage (High) ^(Note 2)	V_{OH}	25 °C	$V_{DD}-0.10$	-	-	V	$R_L=10\text{ k}\Omega$, $V_{RL}=V_{DD}/2\text{ V}$
		Full range	$V_{DD}-0.15$	-	-		
Output Voltage (Low) ^(Note 2)	V_{OL}	25 °C	-	-	$V_{SS}+0.05$	V	$R_L=10\text{ k}\Omega$, $V_{RL}=V_{DD}/2\text{ V}$
		Full range	-	-	$V_{SS}+0.10$		
Large Signal Voltage Gain	A_V	25 °C	-	100	-	dB	$R_L=10\text{ k}\Omega$
Common-mode Input Voltage Range	V_{ICM}	25 °C	0	-	3	V	-
Common-mode Rejection Ratio	CMRR	25 °C	-	80	-	dB	-
Power Supply Rejection Ratio	PSRR	25 °C	-	80	-	dB	-
Output Source Current ^(Note 1,2,3)	I_{SOURCE}	25 °C	1.0	2.0	-	mA	$V_{OUT}=V_{DD}-0.4\text{ V}$
		Full range	0.8	-	-		
Output Sink Current ^(Note 1,2,3)	I_{SINK}	25 °C	3	7	-	mA	$V_{OUT}=V_{SS}+0.4\text{ V}$
		Full range	1	-	-		
Output Rise Time	t_R	25 °C	-	50	-	ns	$C_L=15\text{ pF}$, $V_{-IN}=1.5\text{ V}$, 100 mV Overdrive
Output Fall Time	t_F	25 °C	-	20	-	ns	
Propagation Delay Time L to H ^(Note 2)	t_{PLH}	25 °C	-	1.7	-	μs	
		Full range	-	-	5		
Propagation Delay Time H to L ^(Note 2)	t_{PHL}	25 °C	-	0.6	-	μs	
		Full range	-	-	3		

(Note 1) Absolute value

(Note 2) Full range: $T_a=-40\text{ }^\circ\text{C}$ to $+125\text{ }^\circ\text{C}$

(Note 3) Consider the power dissipation of the IC under high temperature environment when selecting the output current value. When the output pins are short-circuited continuously, the output current may decrease due to the temperature rise by the heat generation of inside the IC.

Typical Performance Curves

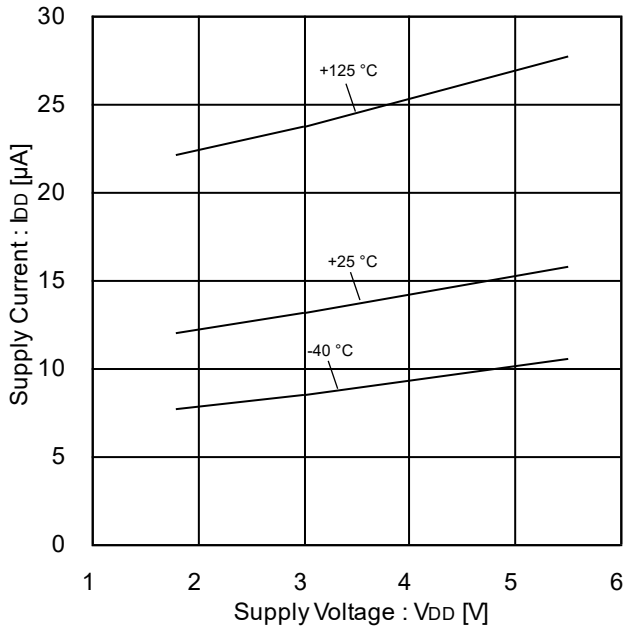

Figure 1. Supply Current vs Supply Voltage

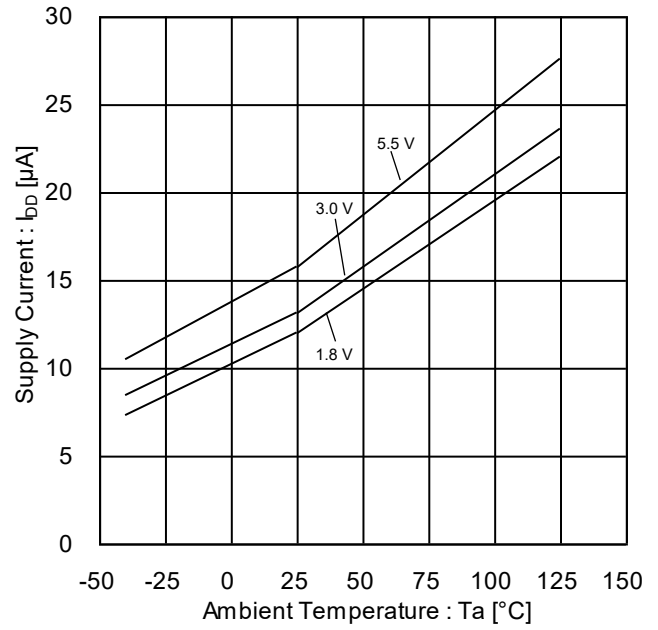

Figure 2. Supply Current vs Ambient Temperature

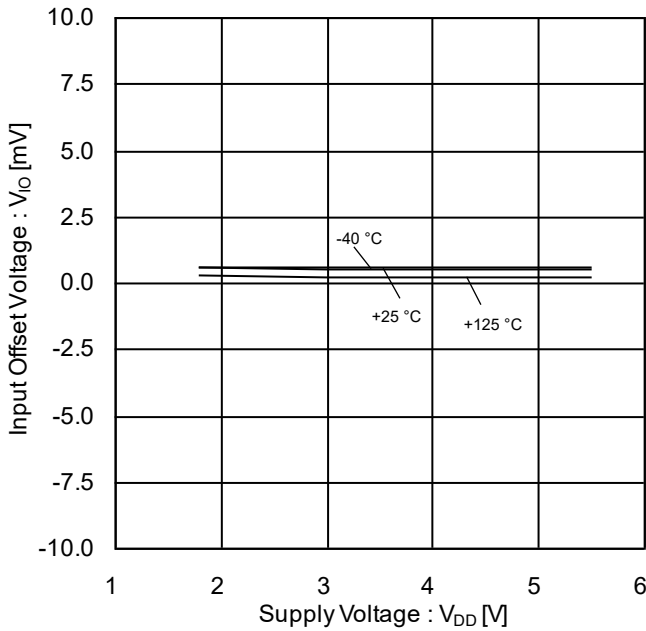

Figure 3. Input Offset Voltage vs Supply Voltage
($V_{ICM}=V_{DD}$, $E_K=-V_{DD}/2$)

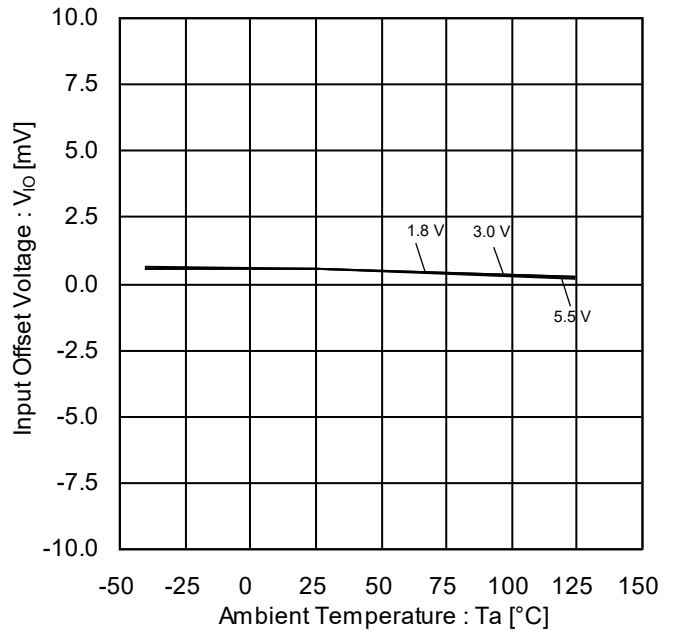

Figure 4. Input Offset Voltage vs Ambient Temperature
($V_{ICM}=V_{DD}$, $E_K=-V_{DD}/2$)

(Note) The above characteristics are measurements of typical sample, they are not guaranteed.

Typical Performance Curves - continued

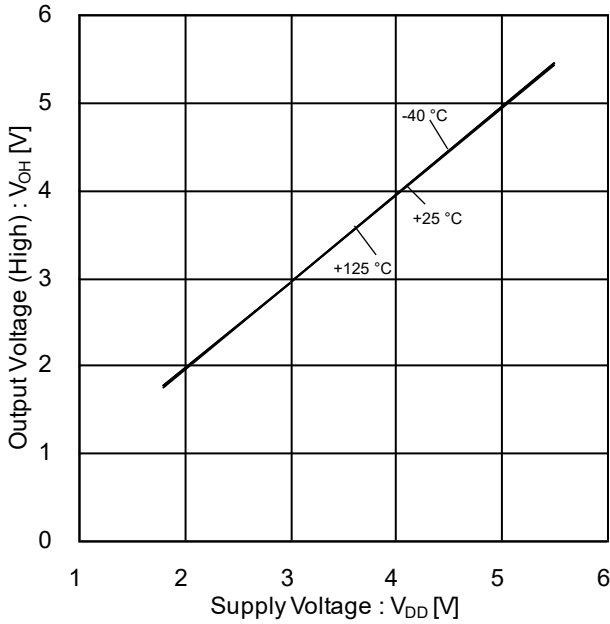

Figure 5. Output Voltage (High) vs Supply Voltage (R_L=10 kΩ)

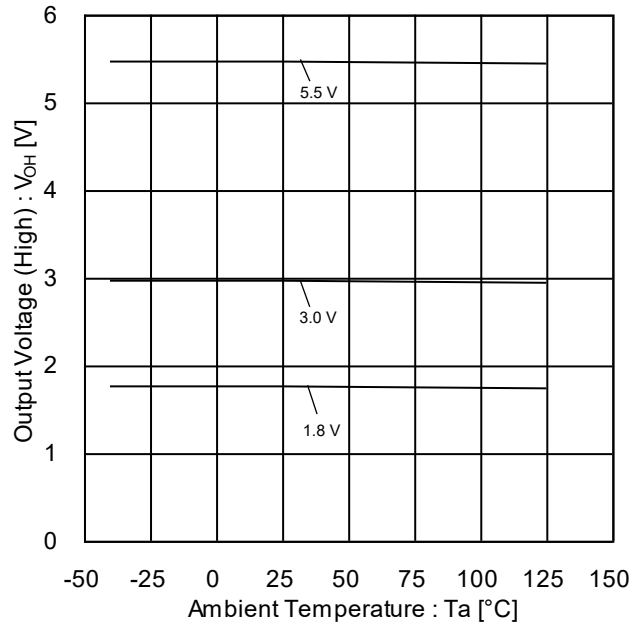

Figure 6. Output Voltage (High) vs Ambient Temperature (R_L=10 kΩ)

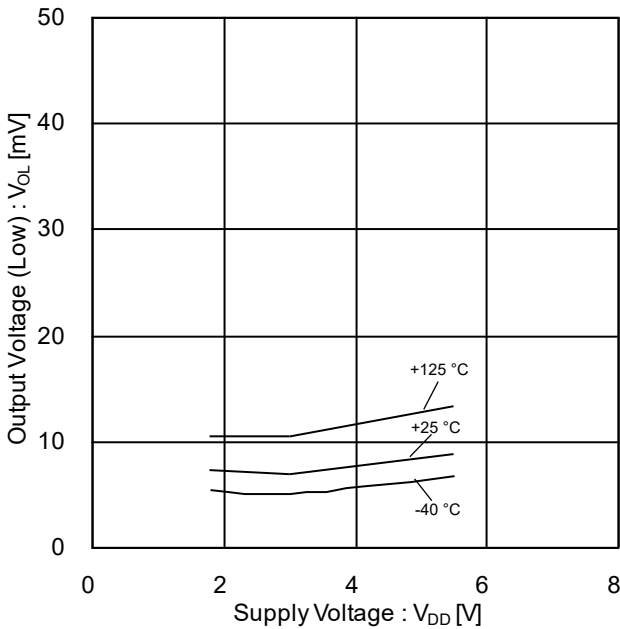

Figure 7. Output Voltage(Low) vs Supply Voltage (R_L=10 kΩ)

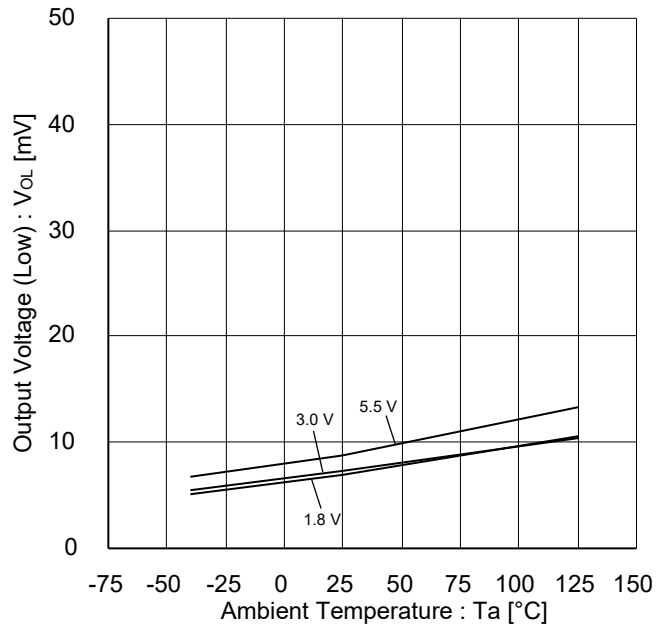

Figure 8. Output Voltage (Low) vs Ambient Temperature (R_L=10 kΩ)

(Note) The above characteristics are measurements of typical sample, they are not guaranteed.

Typical Performance Curves - continued

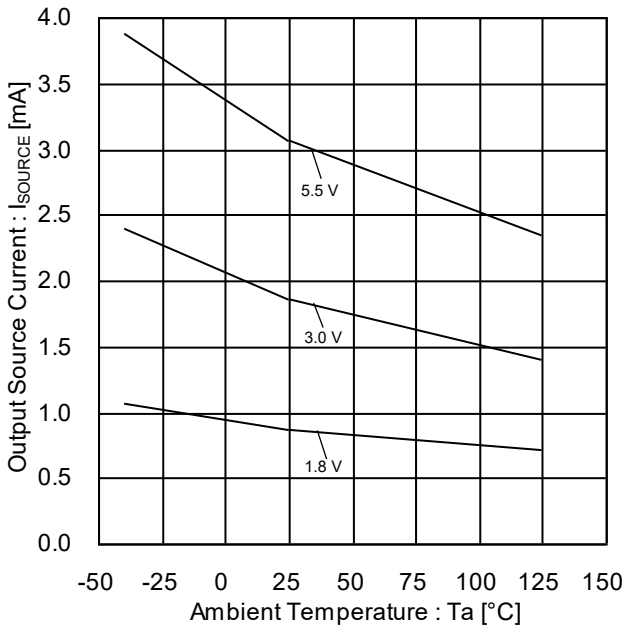

Figure 9. Output Source Current vs Ambient Temperature ($V_{OUT}=V_{DD}-0.4\text{ V}$)

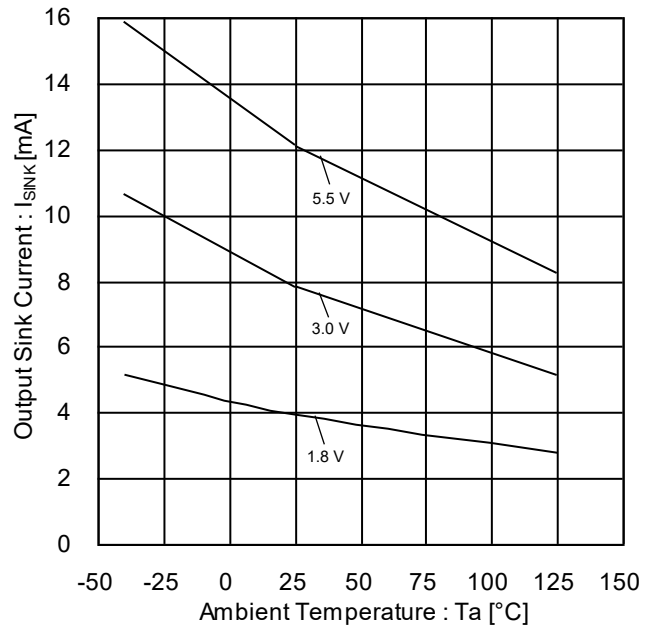

Figure 10. Output Sink Current vs Ambient Temperature ($V_{OUT}=V_{SS}+0.4\text{ V}$)

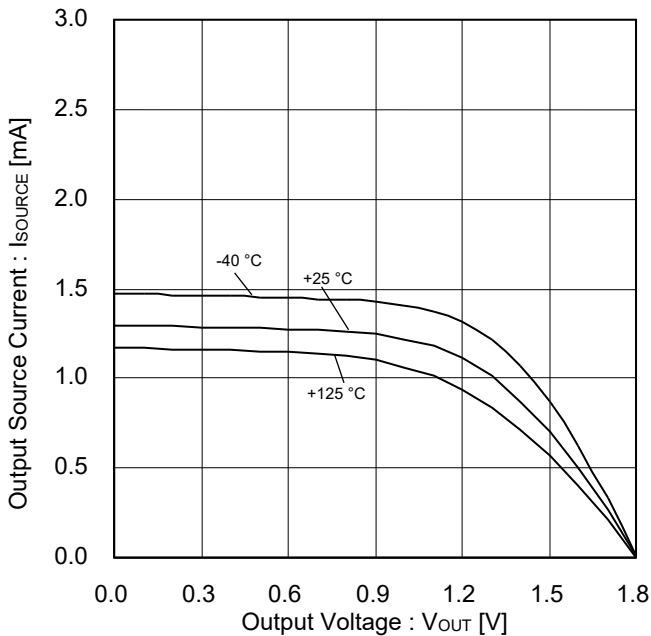

Figure 11. Output Source Current vs Output Voltage ($V_{DD}=1.8\text{ V}$)

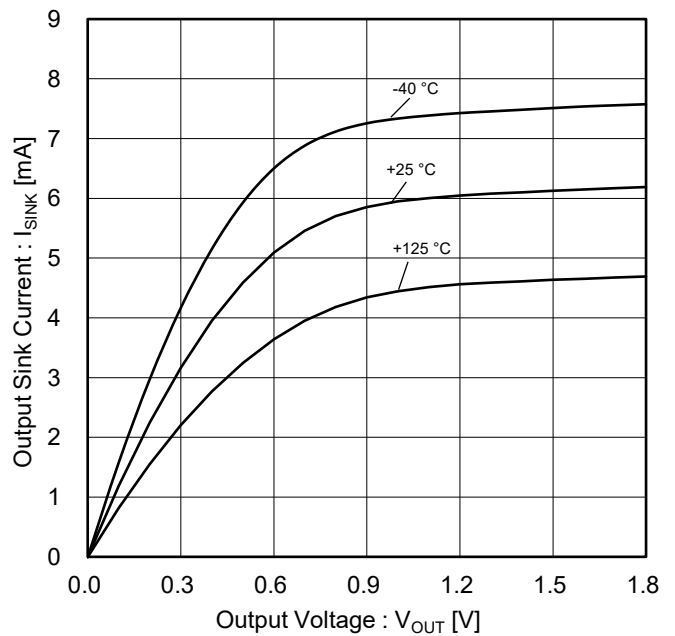

Figure 12. Output Sink Current vs Output Voltage ($V_{DD}=1.8\text{ V}$)

(Note) The above characteristics are measurements of typical sample, they are not guaranteed.

Typical Performance Curves - continued

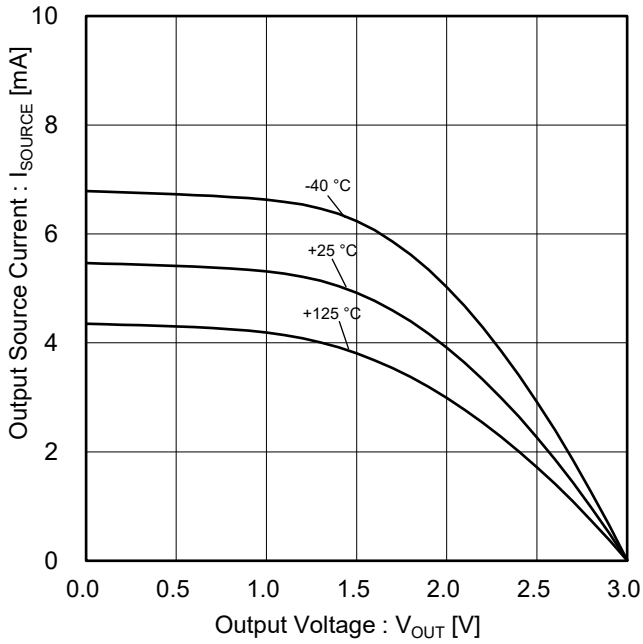

Figure 13. Output Source Current vs Output Voltage (V_{DD}=3.0 V)

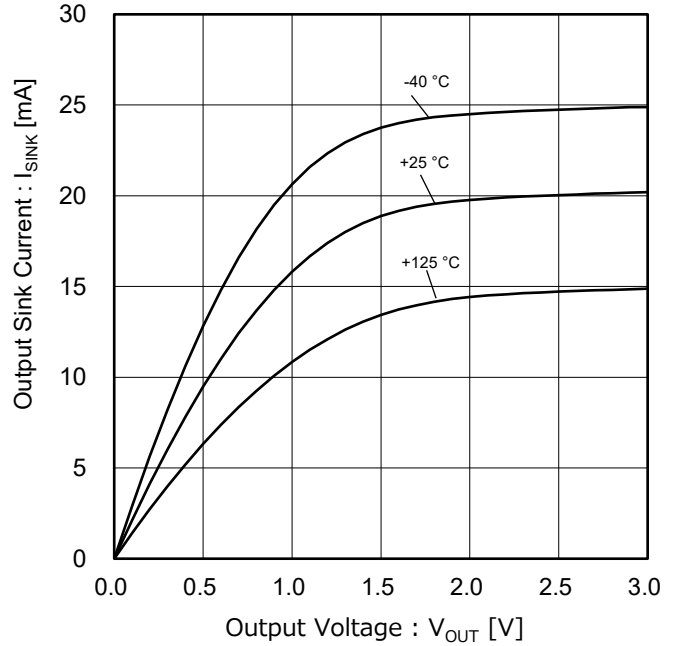

Figure 14. Output Sink Current vs Output Voltage (V_{DD}=3.0 V)

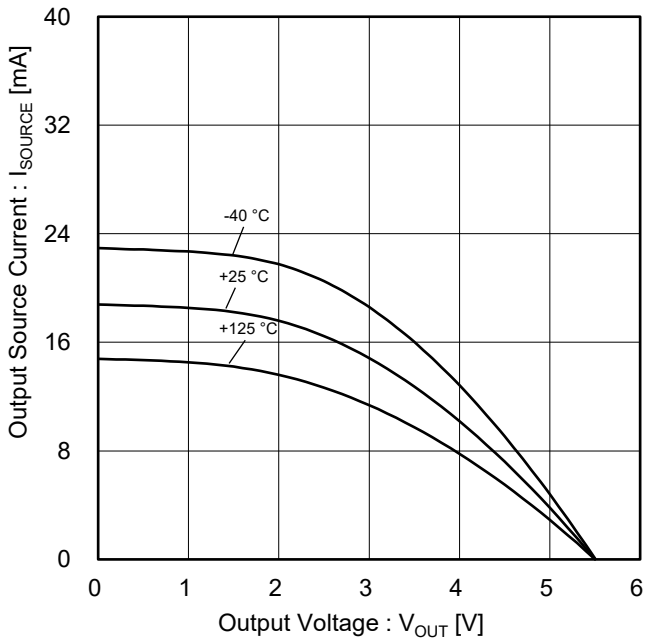

Figure 15. Output Source Current vs Output Voltage (V_{DD}=5.5 V)

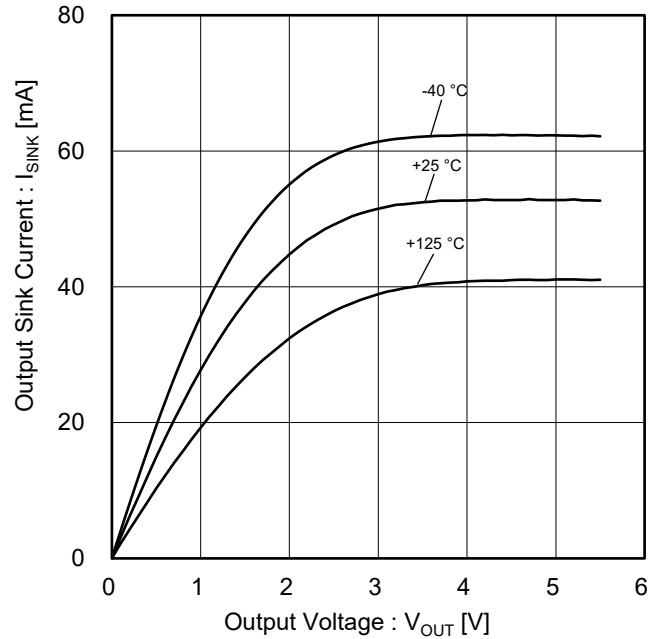

Figure 16. Output Sink Current vs Output Voltage (V_{DD}=5.5 V)

(Note) The above characteristics are measurements of typical sample, they are not guaranteed.

Typical Performance Curves - continued

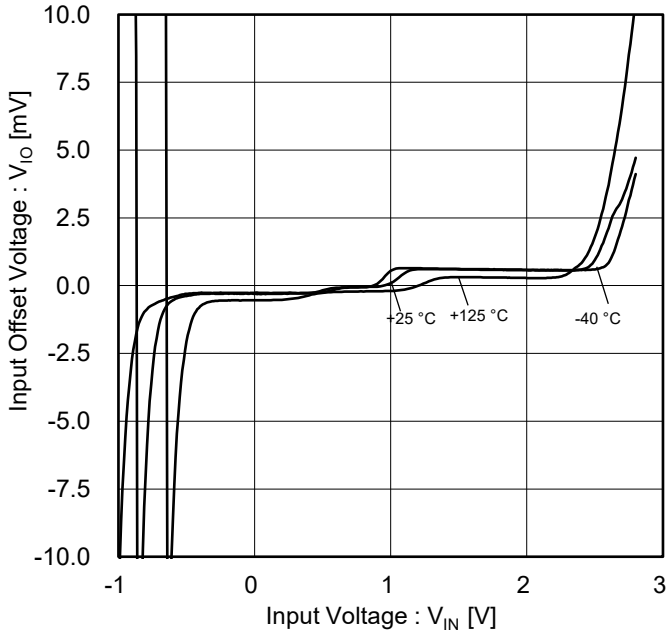

Figure 17. Input Offset Voltage vs Input Voltage (V_{DD}=1.8 V)

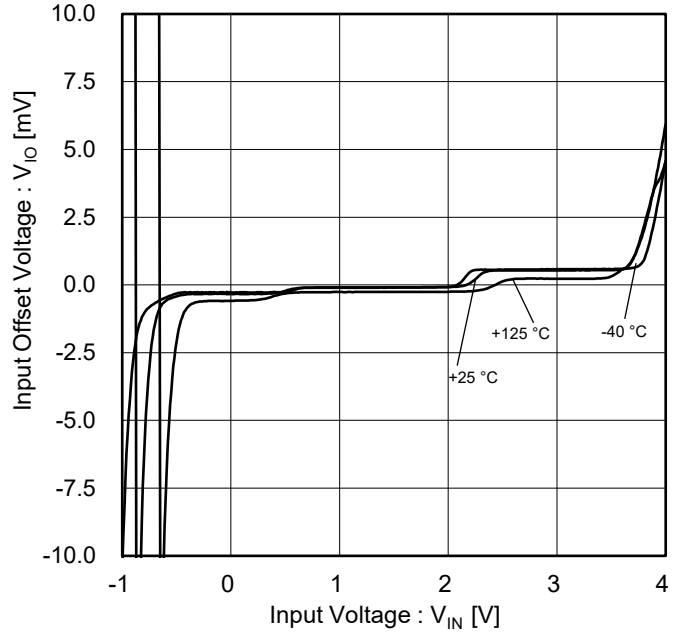

Figure 18. Input Offset Voltage vs Input Voltage (V_{DD}=3.0 V)

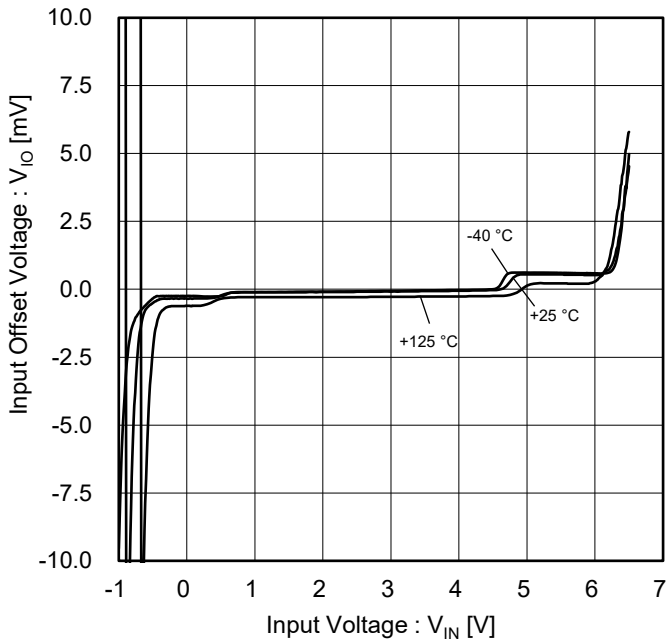

Figure 19. Input Offset Voltage vs Input Voltage (V_{DD}=5.5 V)

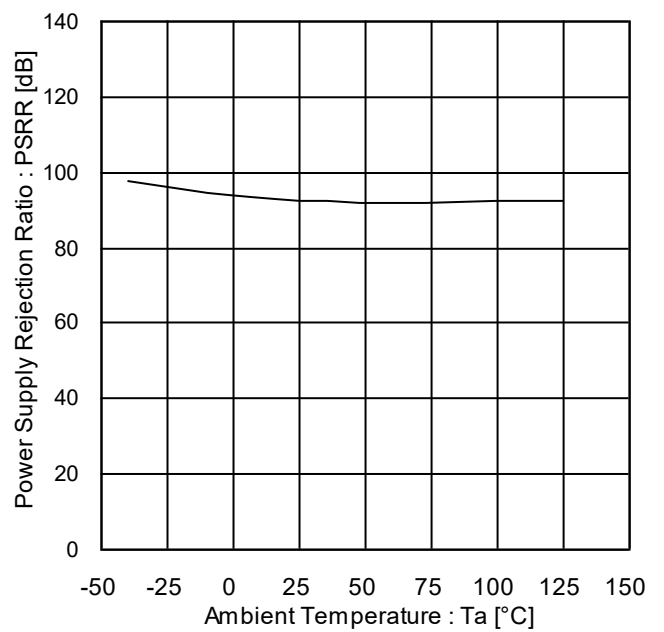

Figure 20. Power Supply Rejection Ratio vs Ambient Temperature

(Note) The above characteristics are measurements of typical sample, they are not guaranteed.

Typical Performance Curves - continued

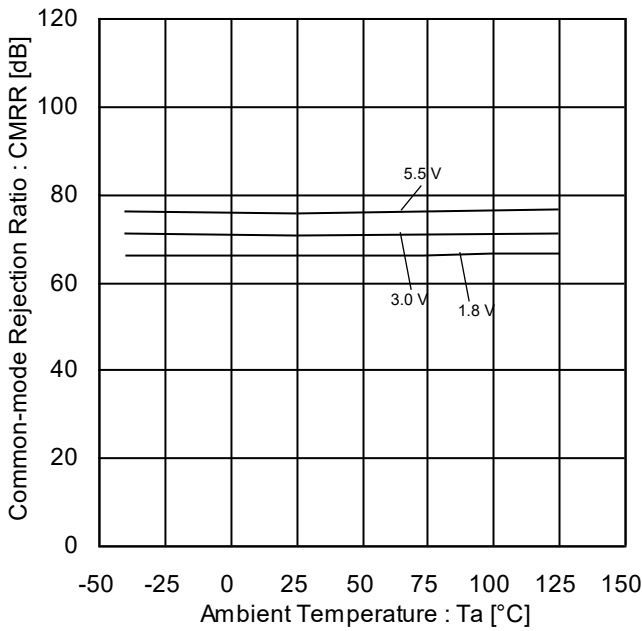

Figure 21. Common-mode Rejection Ratio vs Ambient Temperature

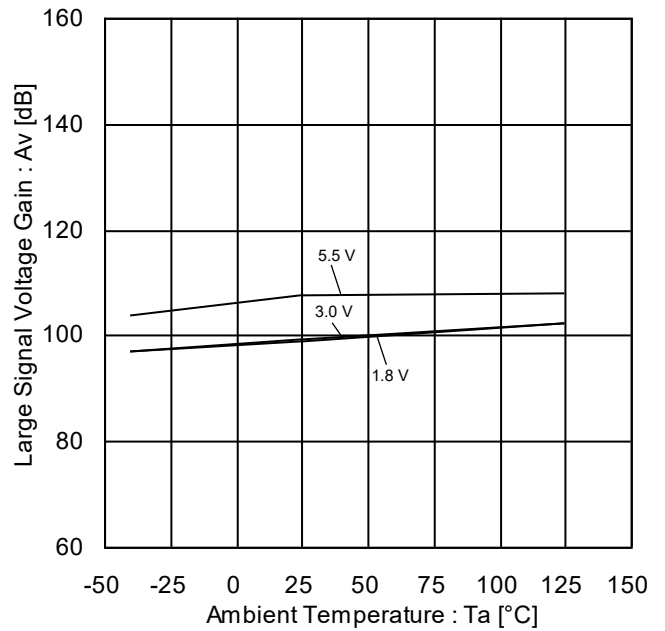

Figure 22. Large Signal Voltage Gain vs Ambient Temperature

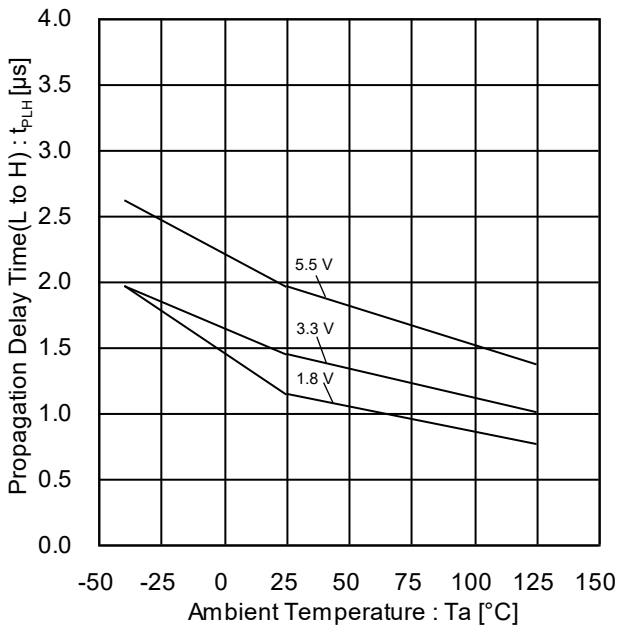

Figure 23. Propagation Delay Time(L to H) vs Ambient Temperature

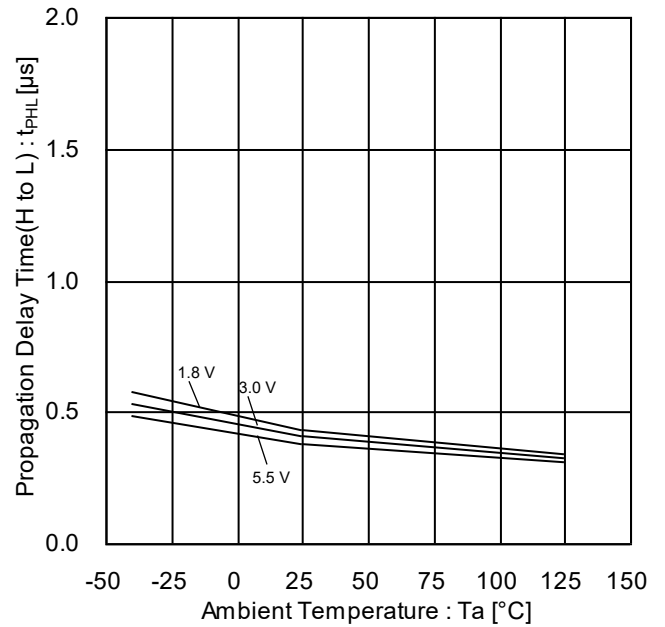

Figure 24. Propagation Delay Time(H to L) vs Ambient Temperature

(Note) The above characteristics are measurements of typical sample, they are not guaranteed.

Application Information

1. Unused Circuits

If there are unused comparators, we recommend connecting as shown below, connecting the non-inverting input pin to the VDD pin and connecting the inverting input pin to the VSS pin.

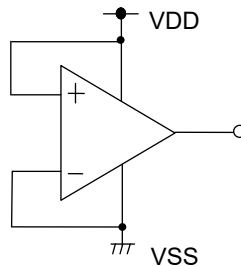

2. Input Voltage

Regardless of the power supply voltage, a voltage of $V_{SS}-0.3\text{ V}$ to $V_{DD}+0.3\text{ V}$ can be applied to the input pin without deteriorating characteristics or destruction.

However, this does not guarantee circuit operation.

Please note that the circuit will not operate properly if it is not within the common-mode input voltage range described in the electrical characteristics.

3. Power Supply (Single / Dual)

The comparator operates when the voltage supplied is between the VDD and VSS pin. Therefore, the single supply comparator can also be used as a dual supply comparator.

4. About the External Capacitor of the Output Pin

When the VDD pin is shorted to the VSS(GND) potential, the accumulated charge of the external capacitor goes through the parasitic element inside the circuit or the pin protection element and is discharged to the VDD pin, so that the elements inside the IC may be damaged (thermal destruction).

When used for applications that do not cause oscillation due to output capacitive load (such as a voltage comparator that does not constitute a negative feedback circuit), in order to prevent damage to the IC due to accumulated charge of the external capacitor, the capacitance of the external capacitor must be $0.1\ \mu\text{F}$ or less.

5. Latch-up

Do not set the voltage of the input/output pin to V_{DD} or more and V_{SS} or less because there is a possibility of latch-up state peculiar to the CMOS device. Also, be careful that the abnormal noise and etc. are not added to the IC.

6. Start-up the Supply Voltage

This IC has ESD protection diode between input pin and the VDD and VSS pin. When apply the voltage to input pin before start-up the supply voltage, then a current flows in the VDD or VSS pin through this diode. The current is depending on applied voltage. This phenomena causes breakdown the IC or malfunction. Therefore, give a special consideration to input pin protection and start-up order of supply voltage.

Also, after turning on the power supply, this IC outputs High level voltage regardless of the state of input up to around 1 V of the start-up voltage of the circuit. Pay attention to the sequence of turning on the power supply and the etc., because there is a possibility of the set malfunction.

Operational Notes

1. Reverse Connection of Power Supply

Connecting the power supply in reverse polarity can damage the IC. Take precautions against reverse polarity when connecting the power supply, such as mounting an external diode between the power supply and the IC's power supply pins.

2. Power Supply Lines

Design the PCB layout pattern to provide low impedance supply lines. Furthermore, connect a capacitor to ground at all power supply pins. Consider the effect of temperature and aging on the capacitance value when using electrolytic capacitors.

3. Ground Voltage

Ensure that no pins are at a voltage below that of the ground pin at any time, even during transient condition.

4. Ground Wiring Pattern

When using both small-signal and large-current ground traces, the two ground traces should be routed separately but connected to a single ground at the reference point of the application board to avoid fluctuations in the small-signal ground caused by large currents. Also ensure that the ground traces of external components do not cause variations on the ground voltage. The ground lines must be as short and thick as possible to reduce line impedance.

5. Recommended Operating Conditions

The function and operation of the IC are guaranteed within the range specified by the recommended operating conditions. The characteristic values are guaranteed only under the conditions of each item specified by the electrical characteristics.

6. Inrush Current

When power is first supplied to the IC, it is possible that the internal logic may be unstable and inrush current may flow instantaneously due to the internal powering sequence and delays, especially if the IC has more than one power supply. Therefore, give special consideration to power coupling capacitance, power wiring, width of ground wiring, and routing of connections.

7. Operation Under Strong Electromagnetic Field

Operating the IC in the presence of a strong electromagnetic field may cause the IC to malfunction.

8. Testing on Application Boards

When testing the IC on an application board, connecting a capacitor directly to a low-impedance output pin may subject the IC to stress. Always discharge capacitors completely after each process or step. The IC's power supply should always be turned off completely before connecting or removing it from the test setup during the inspection process. To prevent damage from static discharge, ground the IC during assembly and use similar precautions during transport and storage.

9. Inter-pin Short and Mounting Errors

Ensure that the direction and position are correct when mounting the IC on the PCB. Incorrect mounting may result in damaging the IC. Avoid nearby pins being shorted to each other especially to ground, power supply and output pin. Inter-pin shorts could be due to many reasons such as metal particles, water droplets (in very humid environment) and unintentional solder bridge deposited in between pins during assembly to name a few.

10. Unused Input Pins

Input pins of an IC are often connected to the gate of a MOS transistor. The gate has extremely high impedance and extremely low capacitance. If left unconnected, the electric field from the outside can easily charge it. The small charge acquired in this way is enough to produce a significant effect on the conduction through the transistor and cause unexpected operation of the IC. So unless otherwise specified, unused input pins should be connected to the power supply or ground line.

11. Regarding the Input Pin of the IC

In the construction of this IC, P-N junctions are inevitably formed creating parasitic diodes or transistors. The operation of these parasitic elements can result in mutual interference among circuits, operational faults, or physical damage. Therefore, conditions which cause these parasitic elements to operate, such as applying a voltage to an input pin lower than the ground voltage should be avoided. Furthermore, do not apply a voltage to the input pins when no power supply voltage is applied to the IC. Even if the power supply voltage is applied, make sure that the input pins have voltages within the values specified in the electrical characteristics of this IC.

12. Ceramic Capacitor

When using a ceramic capacitor, determine a capacitance value considering the change of capacitance with temperature and the decrease in nominal capacitance due to DC bias and others.

Ordering Information

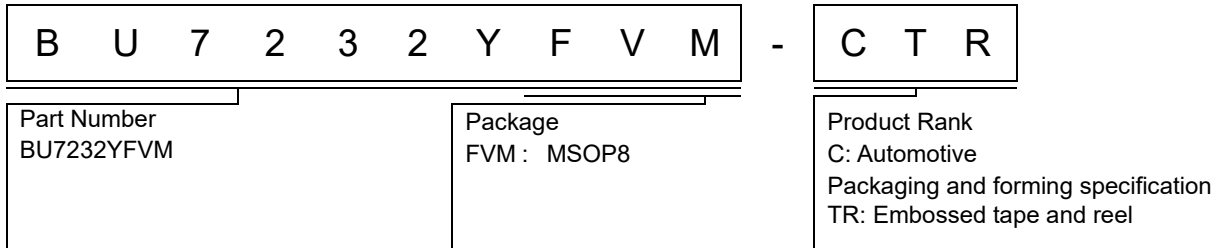

Marking Diagram

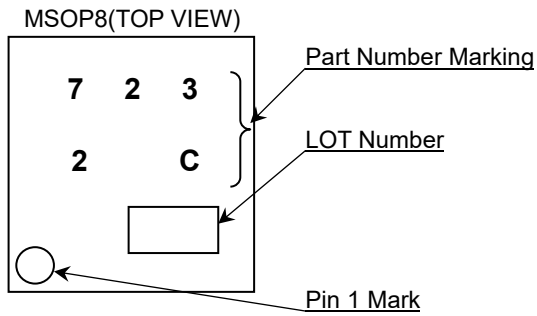

Physical Dimension and Packing Information

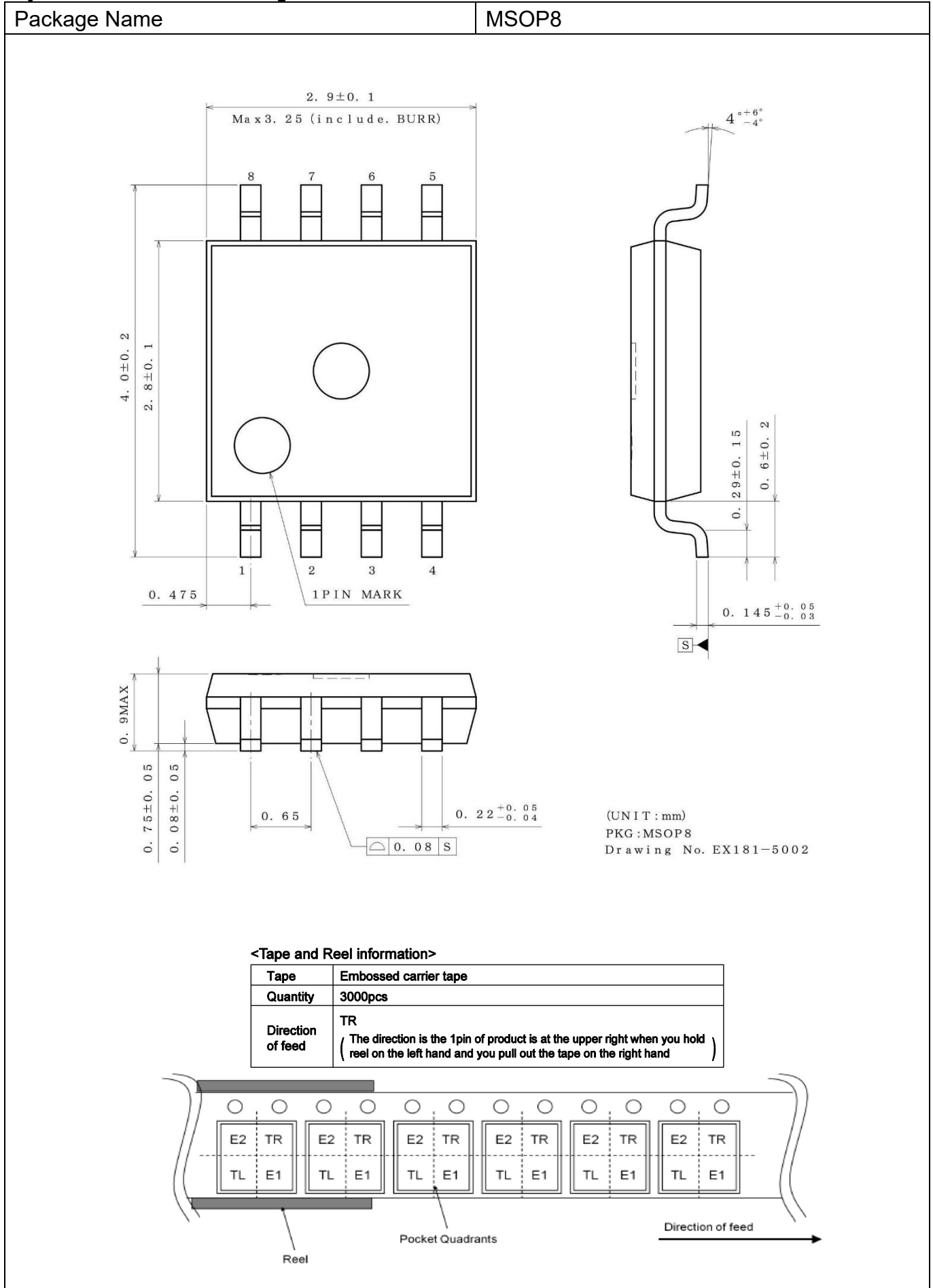

Revision History

Date	Revision	Changes
20.June.2018	001	New Release
06.Sep.2018	002	Electrical Characteristics(IB) : Delete description in the full temperature range
30.Sep.2021	003	Electrical Characteristics(IB) : Delete Max Limit Value

Notice

Precaution on using ROHM Products

1. If you intend to use our Products in devices requiring extremely high reliability (such as medical equipment ^(Note 1), aircraft/spacecraft, nuclear power controllers, etc.) and whose malfunction or failure may cause loss of human life, bodily injury or serious damage to property ("Specific Applications"), please consult with the ROHM sales representative in advance. Unless otherwise agreed in writing by ROHM in advance, ROHM shall not be in any way responsible or liable for any damages, expenses or losses incurred by you or third parties arising from the use of any ROHM's Products for Specific Applications.

(Note1) Medical Equipment Classification of the Specific Applications

JAPAN	USA	EU	CHINA
CLASS III	CLASS III	CLASS II b	CLASS III
CLASS IV		CLASS III	

2. ROHM designs and manufactures its Products subject to strict quality control system. However, semiconductor products can fail or malfunction at a certain rate. Please be sure to implement, at your own responsibilities, adequate safety measures including but not limited to fail-safe design against the physical injury, damage to any property, which a failure or malfunction of our Products may cause. The following are examples of safety measures:
 - [a] Installation of protection circuits or other protective devices to improve system safety
 - [b] Installation of redundant circuits to reduce the impact of single or multiple circuit failure
3. Our Products are not designed under any special or extraordinary environments or conditions, as exemplified below. Accordingly, ROHM shall not be in any way responsible or liable for any damages, expenses or losses arising from the use of any ROHM's Products under any special or extraordinary environments or conditions. If you intend to use our Products under any special or extraordinary environments or conditions (as exemplified below), your independent verification and confirmation of product performance, reliability, etc. prior to use, must be necessary:
 - [a] Use of our Products in any types of liquid, including water, oils, chemicals, and organic solvents
 - [b] Use of our Products outdoors or in places where the Products are exposed to direct sunlight or dust
 - [c] Use of our Products in places where the Products are exposed to sea wind or corrosive gases, including Cl₂, H₂S, NH₃, SO₂, and NO₂
 - [d] Use of our Products in places where the Products are exposed to static electricity or electromagnetic waves
 - [e] Use of our Products in proximity to heat-producing components, plastic cords, or other flammable items
 - [f] Sealing or coating our Products with resin or other coating materials
 - [g] Use of our Products without cleaning residue of flux (Exclude cases where no-clean type fluxes is used. However, recommend sufficiently about the residue.); or Washing our Products by using water or water-soluble cleaning agents for cleaning residue after soldering
 - [h] Use of the Products in places subject to dew condensation
4. The Products are not subject to radiation-proof design.
5. Please verify and confirm characteristics of the final or mounted products in using the Products.
6. In particular, if a transient load (a large amount of load applied in a short period of time, such as pulse, is applied, confirmation of performance characteristics after on-board mounting is strongly recommended. Avoid applying power exceeding normal rated power; exceeding the power rating under steady-state loading condition may negatively affect product performance and reliability.
7. De-rate Power Dissipation depending on ambient temperature. When used in sealed area, confirm that it is the use in the range that does not exceed the maximum junction temperature.
8. Confirm that operation temperature is within the specified range described in the product specification.
9. ROHM shall not be in any way responsible or liable for failure induced under deviant condition from what is defined in this document.

Precaution for Mounting / Circuit board design

1. When a highly active halogenous (chlorine, bromine, etc.) flux is used, the residue of flux may negatively affect product performance and reliability.
2. In principle, the reflow soldering method must be used on a surface-mount products, the flow soldering method must be used on a through hole mount products. If the flow soldering method is preferred on a surface-mount products, please consult with the ROHM representative in advance.

For details, please refer to ROHM Mounting specification

Precautions Regarding Application Examples and External Circuits

1. If change is made to the constant of an external circuit, please allow a sufficient margin considering variations of the characteristics of the Products and external components, including transient characteristics, as well as static characteristics.
2. You agree that application notes, reference designs, and associated data and information contained in this document are presented only as guidance for Products use. Therefore, in case you use such information, you are solely responsible for it and you must exercise your own independent verification and judgment in the use of such information contained in this document. ROHM shall not be in any way responsible or liable for any damages, expenses or losses incurred by you or third parties arising from the use of such information.

Precaution for Electrostatic

This Product is electrostatic sensitive product, which may be damaged due to electrostatic discharge. Please take proper caution in your manufacturing process and storage so that voltage exceeding the Products maximum rating will not be applied to Products. Please take special care under dry condition (e.g. Grounding of human body / equipment / solder iron, isolation from charged objects, setting of Ionizer, friction prevention and temperature / humidity control).

Precaution for Storage / Transportation

1. Product performance and soldered connections may deteriorate if the Products are stored in the places where:
 - [a] the Products are exposed to sea winds or corrosive gases, including Cl₂, H₂S, NH₃, SO₂, and NO₂
 - [b] the temperature or humidity exceeds those recommended by ROHM
 - [c] the Products are exposed to direct sunshine or condensation
 - [d] the Products are exposed to high Electrostatic
2. Even under ROHM recommended storage condition, solderability of products out of recommended storage time period may be degraded. It is strongly recommended to confirm solderability before using Products of which storage time is exceeding the recommended storage time period.
3. Store / transport cartons in the correct direction, which is indicated on a carton with a symbol. Otherwise bent leads may occur due to excessive stress applied when dropping of a carton.
4. Use Products within the specified time after opening a humidity barrier bag. Baking is required before using Products of which storage time is exceeding the recommended storage time period.

Precaution for Product Label

A two-dimensional barcode printed on ROHM Products label is for ROHM's internal use only.

Precaution for Disposition

When disposing Products please dispose them properly using an authorized industry waste company.

Precaution for Foreign Exchange and Foreign Trade act

Since concerned goods might be fallen under listed items of export control prescribed by Foreign exchange and Foreign trade act, please consult with ROHM in case of export.

Precaution Regarding Intellectual Property Rights

1. All information and data including but not limited to application example contained in this document is for reference only. ROHM does not warrant that foregoing information or data will not infringe any intellectual property rights or any other rights of any third party regarding such information or data.
2. ROHM shall not have any obligations where the claims, actions or demands arising from the combination of the Products with other articles such as components, circuits, systems or external equipment (including software).
3. No license, expressly or implied, is granted hereby under any intellectual property rights or other rights of ROHM or any third parties with respect to the Products or the information contained in this document. Provided, however, that ROHM will not assert its intellectual property rights or other rights against you or your customers to the extent necessary to manufacture or sell products containing the Products, subject to the terms and conditions herein.

Other Precaution

1. This document may not be reprinted or reproduced, in whole or in part, without prior written consent of ROHM.
2. The Products may not be disassembled, converted, modified, reproduced or otherwise changed without prior written consent of ROHM.
3. In no event shall you use in any way whatsoever the Products and the related technical information contained in the Products or this document for any military purposes, including but not limited to, the development of mass-destruction weapons.
4. The proper names of companies or products described in this document are trademarks or registered trademarks of ROHM, its affiliated companies or third parties.

General Precaution

1. Before you use our Products, you are requested to carefully read this document and fully understand its contents. ROHM shall not be in any way responsible or liable for failure, malfunction or accident arising from the use of any ROHM's Products against warning, caution or note contained in this document.
2. All information contained in this document is current as of the issuing date and subject to change without any prior notice. Before purchasing or using ROHM's Products, please confirm the latest information with a ROHM sales representative.
3. The information contained in this document is provided on an "as is" basis and ROHM does not warrant that all information contained in this document is accurate and/or error-free. ROHM shall not be in any way responsible or liable for any damages, expenses or losses incurred by you or third parties resulting from inaccuracy or errors of or concerning such information.