

Secondary Buck DC/DC Converter

Single Synchronous Buck DC/DC Converter For Automotive BD9S109NUX-C Evaluation Board

BD9S109NUX-TSB-001 (5.0V Input, 1.2V Output, 1A)

Introduction

This user's guide will provide the necessary steps to operate the Evaluation Board of ROHM's BD9S109NUX-C Buck DC/DC converter. This includes the external parts, operating procedures and application data.

Description

This Evaluation Board was developed for ROHM's single Synchronous buck DC/DC converter BD9S109NUX-C. It is a synchronous buck DC/DC converter with built-in low On Resistance power MOSFETs. BD9S109NUX-C accepts a power supply input range of 2.7 V to 5.5 V and generates a maximum output current of 1 A. Small inductor is applicable due to high switching frequency of 2.2 MHz. It is a current mode control DC/DC Converter and features high-speed transient response. It has a built-in phase compensation circuit. Applications can be created with a few external components.

Application

- Automotive Equipment
- Other Electronic Equipment

Recommended Operating Conditions

Table 1. Recommended Operating Conditions

Parameter	Min	Typ	Max	Units	Conditions
Input Voltage	2.7	-	5.5	V	
Output Voltage (Note1)	0.8	-	VIN	V	
Output Current Range	-	-	1.0	A	
Switching Frequency	-	2.2	-	MHz	
Maximum Efficiency (Vo = 1.2 V)	-	87.32	-	%	VIN = 3.3 V, Io = 0.4A, Ta = 25 °C

(Note 1) Although the minimum output voltage is configurable up to 0.8 V, it may be limited by the SW min ON pulse width. SW Minimum ON Time that BD9S109NUX-C can output stably in the entire load range is 80 ns. Use the value to calculate the input

and output conditions that satisfy the equation of $80 \text{ [ns]} \leq \frac{V_{OUT}}{V_{IN} \times f_{SW}}$

Evaluation Board

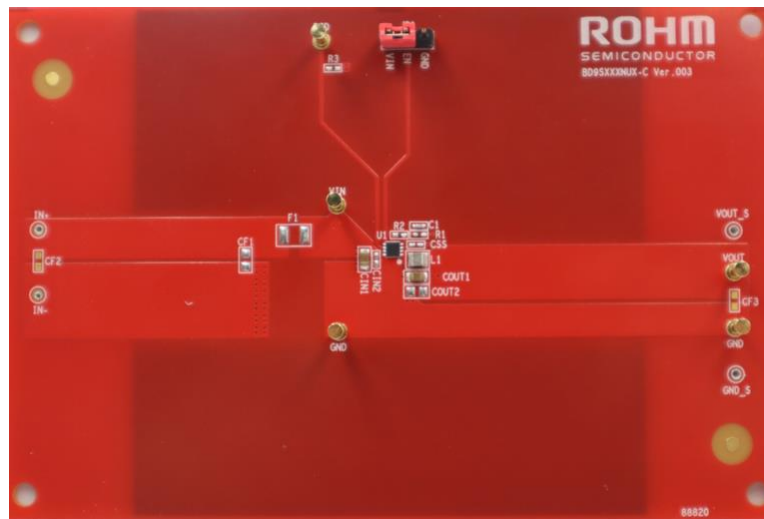

Figure 1. Evaluation Board Top View

Evaluation Board Schematic

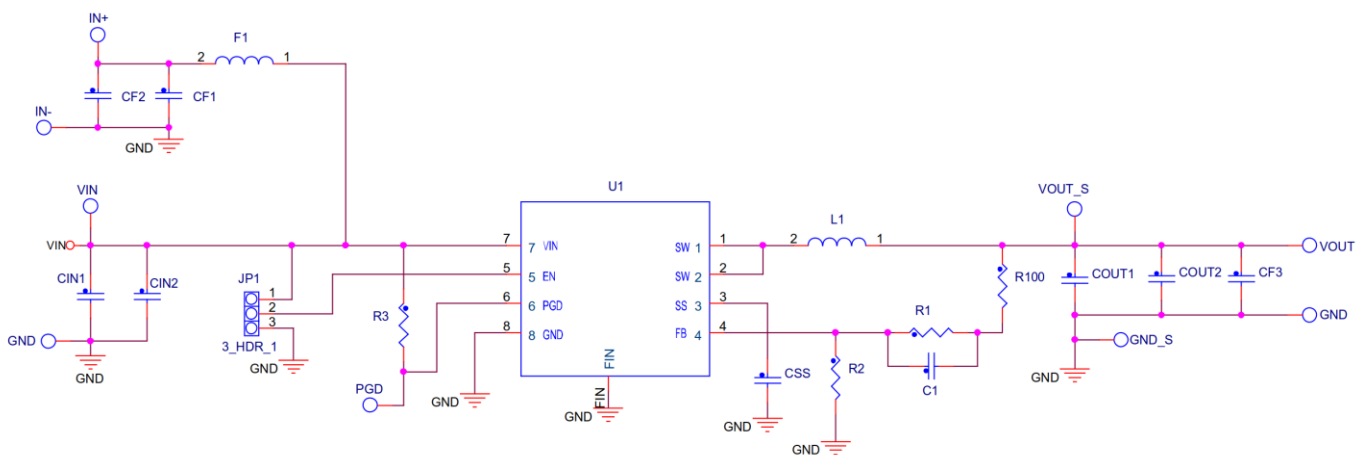

Figure 2. Circuit Diagram

Operating Procedure

1. Turn off EN and connect the GND terminal of the power supply to the GND terminal of Evaluation Board.
2. Connect power supply to the VIN terminal of the Evaluation Board.
3. Connect the load to the Evaluation Board's VOUT and GND terminals. When using an electronic load, connect with the load turned off.
4. Connect a voltmeter to the Evaluation Board's VOUT and GND terminals.
5. Turn on the Power supply of VIN. Turn ON the switch of EN terminal.
6. Make sure that the voltmeter is set to measure voltage.
7. Turn on the electronic load.

(Caution) This Evaluation Board does not support hot plug. Do not perform hot plug test.

(Note) If EN = High (EN short to VIN) before Power ON, the turn ON and turn OFF is controlled by VIN only.

Pin Configuration

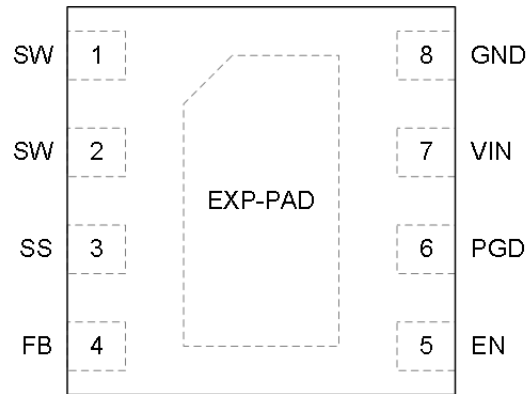

Figure 3. Pin Configuration

Parts list

Table 2. Parts List (VOUT=1.0V, VIN=5.0V, 3.3V)

No	Package	Parameters	Part Name (Series)	Type	Manufacturer
L1	2520	0.68 μ H	DFE252012PD-R68M	Inductor	Murata
COUT1	2012	10 μ F, X7R, 10 V	GCM21BR71A106KE21	Ceramic Capacitor	Murata
CIN1	2012	10 μ F, X7R, 10 V	GCM21BR71A106KE21	Ceramic Capacitor	Murata
R100	-	SHORT	-	-	-
R1 (Note1)	0603	7.5 k Ω , 1 %, 1/20 W	MCR006 series	Chip Resistor	ROHM
R2 (Note1)	0603	30 k Ω , 1 %, 1/20 W	MCR006 series	Chip Resistor	ROHM
R3	0603	100 k Ω , 1 %, 1/20 W	MCR006 series	Chip Resistor	ROHM
CSS	-	-	-	-	-
C1	1005	100 pF, C0G, 50 V	GCM1555C1H101JA16	Ceramic Capacitor	Murata
COUT2	-	-	-	-	-
CIN2	-	-	-	-	-
CF1	-	-	-	-	-
CF2	-	-	-	-	-
F1	-	-	-	-	-
CF3	-	-	-	-	-

Table 3. Parts List (VOUT=1.2V, VIN=5.0V, 3.3V)

No	Package	Parameters	Part Name (Series)	Type	Manufacturer
L1	2520	0.68 μ H	DFE252012PD-R68M	Inductor	Murata
COUT1	2012	10 μ F, X7R, 10 V	GCM21BR71A106KE21	Ceramic Capacitor	Murata
CIN1	2012	10 μ F, X7R, 10 V	GCM21BR71A106KE21	Ceramic Capacitor	Murata
R100	-	SHORT	-	-	-
R1 (Note1)	0603	10 k Ω , 1 %, 1/20 W	MCR006 series	Chip Resistor	ROHM
R2 (Note1)	0603	20 k Ω , 1 %, 1/20 W	MCR006 series	Chip Resistor	ROHM
R3	0603	100 k Ω , 1 %, 1/20 W	MCR006 series	Chip Resistor	ROHM
CSS	-	-	-	-	-
C1	1005	100 pF, C0G, 50 V	GCM1555C1H101JA16	Ceramic Capacitor	Murata
COUT2	-	-	-	-	-
CIN2	-	-	-	-	-
CF1	-	-	-	-	-
CF2	-	-	-	-	-
F1	-	-	-	-	-
CF3	-	-	-	-	-

Table 4. Parts List (VOUT=1.5V, VIN=5.0V, 3.3V)

No	Package	Parameters	Part Name (Series)	Type	Manufacturer
L1	2520	0.68 μ H	DFE252012PD-R68M	Inductor	Murata
COUT1	2012	10 μ F, X7R, 10 V	GCM21BR71A106KE21	Ceramic Capacitor	Murata
CIN1	2012	10 μ F, X7R, 10 V	GCM21BR71A106KE21	Ceramic Capacitor	Murata
R100	-	SHORT	-	-	-
R1 (Note1)	0603	16 k Ω , 1 %, 1/20 W	MCR006 series	Chip Resistor	ROHM
R2 (Note1)	0603	18 k Ω , 1 %, 1/20 W	MCR006 series	Chip Resistor	ROHM
R3	0603	100 k Ω , 1 %, 1/20 W	MCR006 series	Chip Resistor	ROHM
CSS	-	-	-	-	-
C1	1005	100 pF, C0G, 50 V	GCM1555C1H101JA16	Ceramic Capacitor	Murata
COUT2	-	-	-	-	-
CIN2	-	-	-	-	-
CF1	-	-	-	-	-
CF2	-	-	-	-	-
F1	-	-	-	-	-
CF3	-	-	-	-	-

Table 5. Parts List (VOUT=1.8V, VIN=5.0V, 3.3V)

No	Package	Parameters	Part Name (Series)	Type	Manufacturer
L1	2520	1.0 μ H	TFM252012ALMA1R0M	Inductor	TDK
COUT1	2012	10 μ F, X7R, 10 V	GCM21BR71A106KE21	Ceramic Capacitor	Murata
CIN1	2012	10 μ F, X7R, 10 V	GCM21BR71A106KE21	Ceramic Capacitor	Murata
R100	-	SHORT	-	-	-
R1 (Note1)	0603	30 k Ω , 1 %, 1/20 W	MCR006 series	Chip Resistor	ROHM
R2 (Note1)	0603	24 k Ω , 1 %, 1/20 W	MCR006 series	Chip Resistor	ROHM
R3	0603	100 k Ω , 1 %, 1/20 W	MCR006 series	Chip Resistor	ROHM
CSS	-	-	-	-	-
C1	1005	100 pF, C0G, 50 V	GCM1555C1H101JA16	Ceramic Capacitor	Murata
COUT2	-	-	-	-	-
CIN2	-	-	-	-	-
CF1	-	-	-	-	-
CF2	-	-	-	-	-
F1	-	-	-	-	-
CF3	-	-	-	-	-

Table 6. Parts List (VOUT=3.3V, VIN=5.0V)

No	Package	Parameters	Part Name (Series)	Type	Manufacturer
L1	2520	1.0 μ H	TFM252012ALMA1R0M	Inductor	TDK
COUT1	2012	10 μ F, X7R, 10 V	GCM21BR71A106KE21	Ceramic Capacitor	Murata
CIN1	2012	10 μ F, X7R, 10 V	GCM21BR71A106KE21	Ceramic Capacitor	Murata
R100	-	SHORT	-	-	-
R1 (Note1)	0603	75 k Ω , 1 %, 1/20 W	MCR006 series	Chip Resistor	ROHM
R2 (Note1)	0603	24 k Ω , 1 %, 1/20 W	MCR006 series	Chip Resistor	ROHM
R3	0603	100 k Ω , 1 %, 1/20 W	MCR006 series	Chip Resistor	ROHM
CSS	-	-	-	-	-
C1	1005	100 pF, C0G, 50 V	GCM1555C1H101JA16	Ceramic Capacitor	Murata
COUT2	-	-	-	-	-
CIN2	-	-	-	-	-
CF1	-	-	-	-	-
CF2	-	-	-	-	-
F1	-	-	-	-	-
CF3	-	-	-	-	-

(Note 1) $V_{OUT} = \frac{R1+R2}{R2} \times 0.8$ [V]

(Note 2) CSS, COUT2, CIN2, CF1, CF2, F1, CF3 patterns are only optional. They can be utilized for adjusting the characteristics constants.

(Note 3) If the recommended parts on tables 2, 3, 4, 5 and 6 are not available anymore due to end of production, different parts will be used on the test board because the end of production parts are deprecated.

Board Layout

Evaluation Board PCB information

Number of Layers	Material	Board Size	Copper Thickness
4	FR4 High TG	114.3mm x 76.2mm x 1.6mm	2oz(70μm) / 1oz (35μm) / 1oz (35μm) / 2oz(70μm)

The layout of BD9SXXXNUX-C series board is shown below.

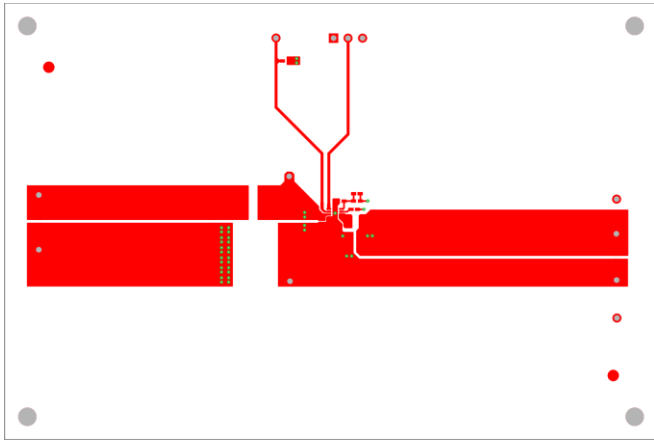

Figure 4. Top Layer Layout

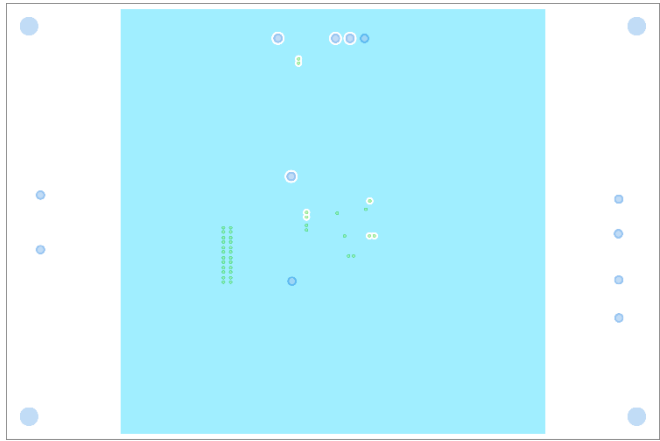

Figure 5. Middle1 Layer Layout

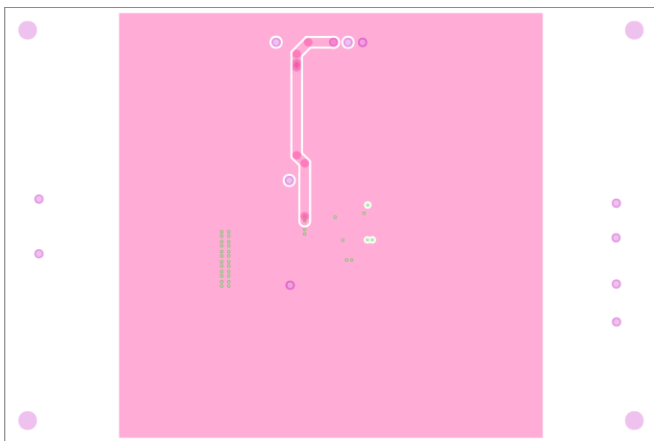

Figure 6. Middle2 Layer Layout

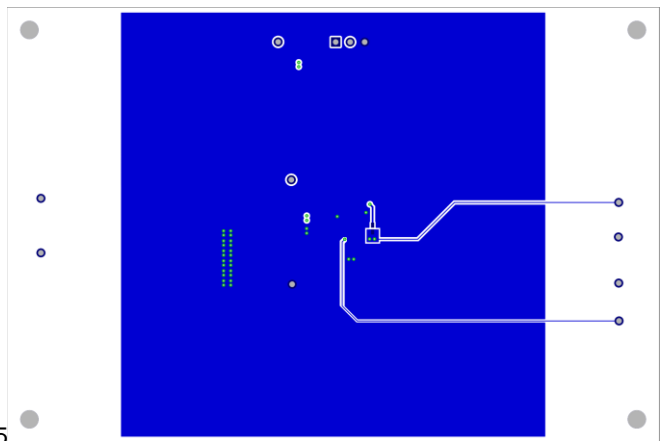

Figure 7. Bottom Layer Layout

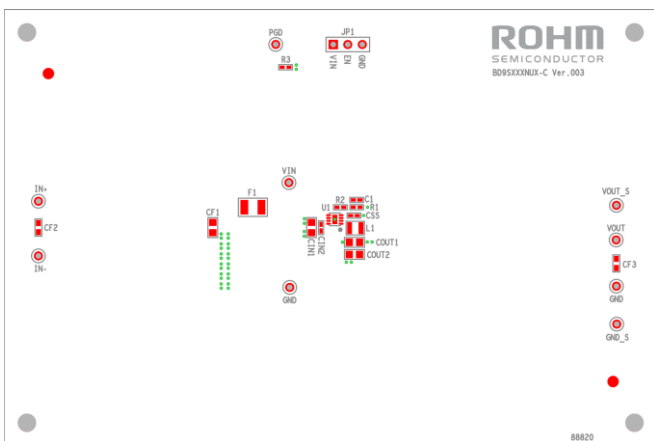

Figure 8. Top Parts Placement

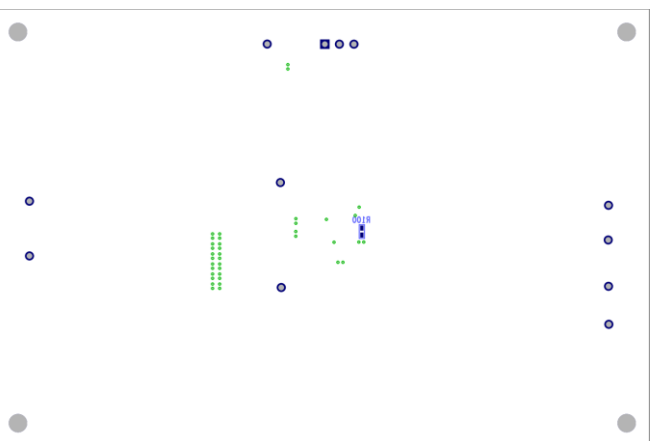

Figure 9. Bottom Parts Placement

Revision History

Date	Revision Number	Description
16.Apr.2024	001	New Release

Notice

- 1) The information contained in this document is intended to introduce ROHM Group (hereafter referred to as ROHM) products. When using ROHM products, please verify the latest specifications or datasheets before use.
- 2) ROHM products are designed and manufactured for use in general electronic equipment and applications (such as Audio Visual equipment, Office Automation equipment, telecommunication equipment, home appliances, amusement devices, etc.) or specified in the datasheets. Therefore, please contact the ROHM sales representative before using ROHM products in equipment or devices requiring extremely high reliability and whose failure or malfunction may cause danger or injury to human life or body or other serious damage (such as medical equipment, transportation, traffic, aircraft, spacecraft, nuclear power controllers, fuel control, automotive equipment including car accessories, etc. hereafter referred to as Specific Applications). Unless otherwise agreed in writing by ROHM in advance, ROHM shall not be in any way responsible or liable for any damages, expenses, or losses incurred by you or third parties arising from the use of ROHM Products for Specific Applications.
- 3) Electronic components, including semiconductors, can fail or malfunction at a certain rate. Please be sure to implement, at your own responsibilities, adequate safety measures including but not limited to fail-safe design against physical injury, and damage to any property, which a failure or malfunction of products may cause.
- 4) The information contained in this document, including application circuit examples and their constants, is intended to explain the standard operation and usage of ROHM products, and is not intended to guarantee, either explicitly or implicitly, the operation of the product in the actual equipment it will be used. As a result, you are solely responsible for it, and you must exercise your own independent verification and judgment in the use of such information contained in this document. ROHM shall not be in any way responsible or liable for any damages, expenses, or losses incurred by you or third parties arising from the use of such information.
- 5) When exporting ROHM products or technologies described in this document to other countries, you must abide by the procedures and provisions stipulated in all applicable export laws and regulations, such as the Foreign Exchange and Foreign Trade Act and the US Export Administration Regulations, and follow the necessary procedures in accordance with these provisions.
- 6) The technical information and data described in this document, including typical application circuits, are examples only and are not intended to guarantee to be free from infringement of third parties intellectual property or other rights. ROHM does not grant any license, express or implied, to implement, use, or exploit any intellectual property or other rights owned or controlled by ROHM or any third parties with respect to the information contained herein.
- 7) No part of this document may be reprinted or reproduced in any form by any means without the prior written consent of ROHM.
- 8) All information contained in this document is current as of the date of publication and subject to change without notice. Before purchasing or using ROHM products, please confirm the latest information with the ROHM sales representative.
- 9) ROHM does not warrant that the information contained herein is error-free. ROHM shall not be in any way responsible or liable for any damages, expenses, or losses incurred by you or third parties resulting from errors contained in this document.



Thank you for your accessing to ROHM product informations.
More detail product informations and catalogs are available, please contact us.

ROHM Customer Support System

<https://www.rohm.com/contactus>