

Switching Regulator Series

Integrated MOSFET Single Synchronous Buck DC/DC Converter

BD9E201FP4-Z Evaluation Board

BD9E201FP4-EVK-001 (12V Input, 5V Output, 2A)

Introduction

This user's guide will provide the necessary steps to operate the Evaluation Board of ROHM's BD9E201FP4-Z Single Synchronous Buck DC/DC converter. This includes the external parts and operating procedures. For the reference application data please refer to the datasheet.

Description

This Evaluation Board was developed for ROHM's single Synchronous buck DC/DC converter BD9E201FP4-Z. BD9E201FP4-Z is a synchronous buck DC/DC converter with built-in low On Resistance power MOSFETs. The BD9E201FP4-Z accepts a power supply input range of 4.5 V to 28 V and generates a maximum output current of 2 A. BD9E201FP4-Z includes internal phase compensation. It achieves the high power density and offers a small footprint on the PCB by employing small package.

Application

- Home Appliance Products
- Secondary Power Supply and Adapter Equipment
- Telecommunication Devices

Recommended Operating Conditions

Table 1. Recommended Operating Conditions

Parameter	Min	Typ	Max	Units	Conditions
Input Voltage	4.5	-	28	V	
Output Voltage	0.7	-	$V_{IN} \times 0.8$	V	(Note 2)
Output Current Range	0	-	2.0	A	
Switching Frequency	-	350	-	kHz	
Maximum Efficiency	-	95.5	-	%	$V_{IN} = 12.0\text{ V}$, $V_o = 5.0\text{ V}$, $I_o = 0.7\text{ A}$, $T_a = 25\text{ }^\circ\text{C}$

(Note 1) T_j must be 150 °C or less under the actual operating environment. Lifetime is derated at junction temperature greater than 125 °C.

(Note 2) Please use within the range of $V_{OUT} \geq V_{IN} \times 0.1\text{ V}$.

Evaluation Board

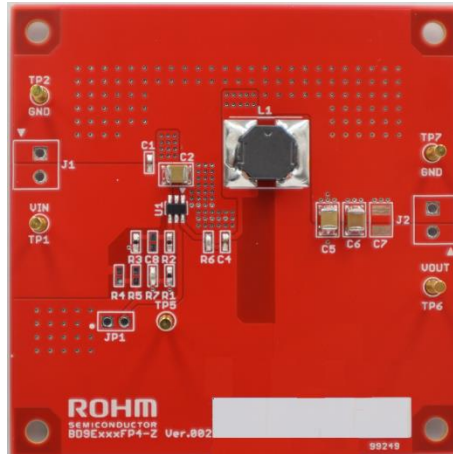

Figure 1. Evaluation Board Top View

Evaluation Board Schematic

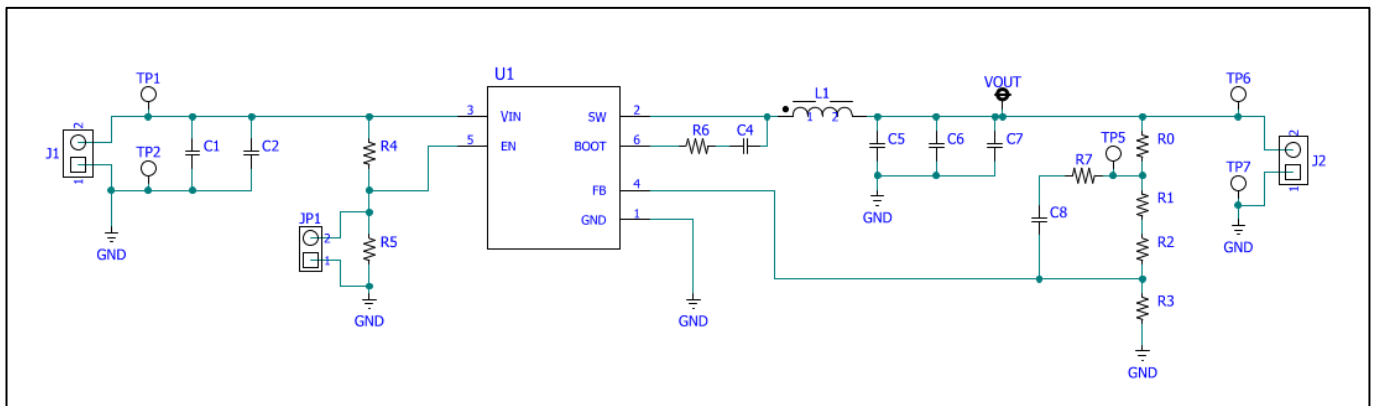

Figure 2. Circuit Diagram

Operating Procedure

1. Connect the GND terminal of the power supply to the GND terminal of Evaluation Board.
2. Connect power supply to the VIN pin of the Evaluation Board.
3. Connect the load to the Evaluation Board's VOUT and GND terminals. When using an electronic load, connect with the load turned off.
4. Connect a voltmeter to the Evaluation Board's VOUT and GND terminals.
5. Turn on the Power supply of VIN.
6. Make sure that the voltmeter is set to measure voltage.
7. Turn on the electronic load.

(Caution) This Evaluation Board does not support hot plug. Do not perform hot plug test.

(Note 1) Enable pin's initial setting is open. The IC's power is controlled only by VIN, because EN is internally pulled-up to the internal regulator voltage by a 1 M Ω (Typ) resistor.

Pin Configuration

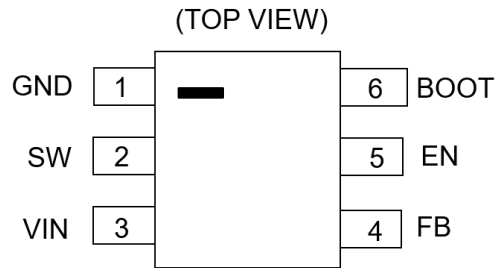

Figure 3. Pin Configuration

Parts List

Table 2. Parts list (VOUT = 3.3 V)

No	Package	Parameters	Part Name (Series)	Type	Manufacturer
L1	8080	10 μ H	1217AS-H-100M	Inductor	Murata
C1 (Note1)	1005	0.1 μ F (50 V, X5R, \pm 10 %)	GRM155R61H104KE14	Ceramic Capacitor	Murata
C2 (Note2)	3225	10 μ F (100 V, X7S, \pm 10 %)	GRM32EC72A106KE05	Ceramic Capacitor	Murata
C4 (Note3)	1005	0.1 μ F (50 V, X5R, \pm 10 %)	GRM155R61H104KE14	Ceramic Capacitor	Murata
R6	-	Short	-	-	-
C5 (Note4)	3225	22 μ F (25 V, X7R, \pm 10 %)	GRM32ER71E226KE15	Ceramic Capacitor	Murata
C6 (Note4)	3225	22 μ F (25 V, X7R, \pm 10 %)	GRM32ER71E226KE15	Ceramic Capacitor	Murata
C7 (Note4)	-	-	-	-	-
C8	-	-	-	-	-
R7	-	Short	-	-	-
R1	-	Short	-	-	-
R2	1005	100 k Ω (1 %, 1/16 W)	MCR01MZPF1003	Chip Resistor	ROHM
R3	1005	22 k Ω (1 %, 1/16 W)	MCR01MZPF2202	Chip Resistor	ROHM
R4	-	-	-	-	-
R5	-	-	-	-	-
R0 (Note5)	-	Short	-	-	-

Table 3. Parts list (VOUT = 5.0 V)

No	Package	Parameters	Part Name (Series)	Type	Manufacturer
L1	8080	15 μ H	1217AS-H-150M	Inductor	Murata
C1 (Note1)	1005	0.1 μ F (50 V, X5R, \pm 10 %)	GRM155R61H104KE14	Ceramic Capacitor	Murata
C2 (Note2)	3225	10 μ F (100 V, X7S, \pm 10 %)	GRM32EC72A106KE05	Ceramic Capacitor	Murata
C4 (Note3)	1005	0.1 μ F (50 V, X5R, \pm 10 %)	GRM155R61H104KE14	Ceramic Capacitor	Murata
R6	-	Short	-	-	-
C5 (Note4)	3225	22 μ F (25 V, X7R, \pm 10 %)	GRM32ER71E226KE15	Ceramic Capacitor	Murata
C6 (Note4)	3225	22 μ F (25 V, X7R, \pm 10 %)	GRM32ER71E226KE15	Ceramic Capacitor	Murata
C7 (Note4)	-	-	-	-	-
C8	-	-	-	-	-
R7	-	Short	-	-	-
R1	1005	0.82 k Ω (1 %, 1/16 W)	MCR01MZPF8200	Chip Resistor	ROHM
R2	1005	110 k Ω (1 %, 1/16 W)	MCR01MZPF1103	Chip Resistor	ROHM
R3	1005	15 k Ω (1 %, 1/16 W)	MCR01MZPF1502	Chip Resistor	ROHM
R4	-	-	-	-	-
R5	-	-	-	-	-
R0 (Note5)	-	Short	-	-	-

Table 4. Parts list (VOUT = 12.0 V)

No	Package	Parameters	Part Name (Series)	Type	Manufacturer
L1	8080	22 μ H	1217AS-H-220M	Inductor	Murata
C1 (Note1)	1005	0.1 μ F (50 V, X5R, \pm 10 %)	GRM155R61H104KE14	Ceramic Capacitor	Murata
C2 (Note2)	3225	10 μ F (100 V, X7S, \pm 10 %)	GRM32EC72A106KE05	Ceramic Capacitor	Murata
C4 (Note3)	1005	0.1 μ F (50 V, X5R, \pm 10 %)	GRM155R61H104KE14	Ceramic Capacitor	Murata
R6	-	Short	-	-	-
C5 (Note4)	3225	22 μ F (25 V, X7R, \pm 10 %)	GRM32ER71E226KE15	Ceramic Capacitor	Murata
C6 (Note4)	3225	22 μ F (25 V, X7R, \pm 10 %)	GRM32ER71E226KE15	Ceramic Capacitor	Murata
C7 (Note4)	-	-	-	-	-
C8	-	-	-	-	-
R7	-	Short	-	-	-
R1	-	Short	-	-	-
R2	1005	130 k Ω (1 %, 1/16 W)	MCR01MZPF1303	Chip Resistor	ROHM
R3	1005	6.8 k Ω (1 %, 1/16 W)	MCR01MZPF6801	Chip Resistor	ROHM
R4	-	-	-	-	-
R5	-	-	-	-	-
R0 (Note5)	-	Short	-	-	-

(Note 1) In order to reduce the influence of high frequency noise, connect a 0.1 μ F ceramic capacitor C1 as close as possible to the VIN pin and the GND pin.

(Note 2) For the input capacitor C2, take temperature characteristics, DC bias characteristics, etc. into consideration and set the actual capacitance to no less than 3.0 μ F.

(Note 3) For the bootstrap capacitor C4, take temperature characteristics, DC bias characteristics, etc. into consideration and set the actual capacitance to no less than 0.022 μ F.

(Note 4) Because the actual capacitance value is changing due to temperature characteristics, DC bias characteristics, etc. of the output capacitor C5, C6 and C7, the loop response characteristics may change. Please confirm the actual application.

(Note 5) R0 is an option used for feedback's frequency response measurement. By inserting a resistor at R0, it is possible to measure the frequency response (phase margin) using an FRA. However, the resistor should not be used in actual application so please short this resistor pattern during actual application.

(Note 6) If the recommended parts on tables 2, 3 and 4 are not available anymore due to end of production, different parts will be used on the test board because the end of production parts are deprecated.

Board Layout

Evaluation Board PCB information

Number of Layers	Material	Board Size	Copper Thickness
4	FR-4	114.3mm x 76.2mm x 1.6mm	2oz(70μm) / 1oz (35μm) / 1oz (35μm) / 2oz(70μm)

The layout of BD9E201FP4-Z is shown below:

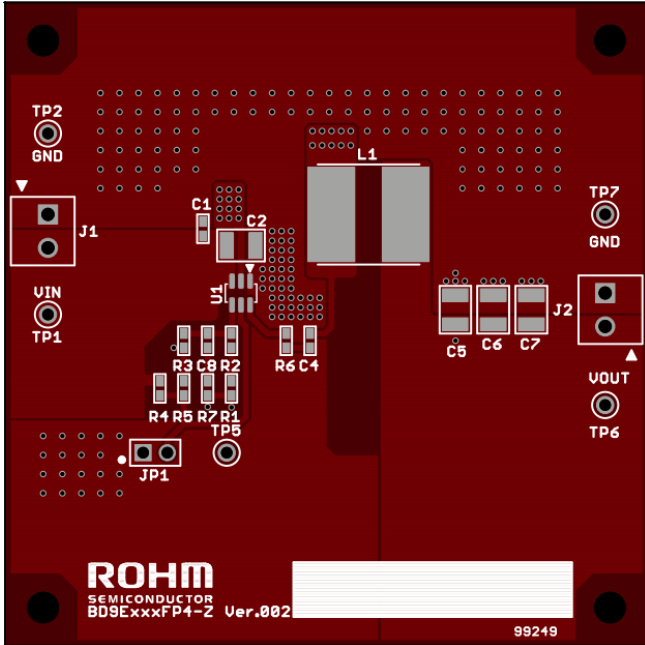

Figure 4. Top PCB Image

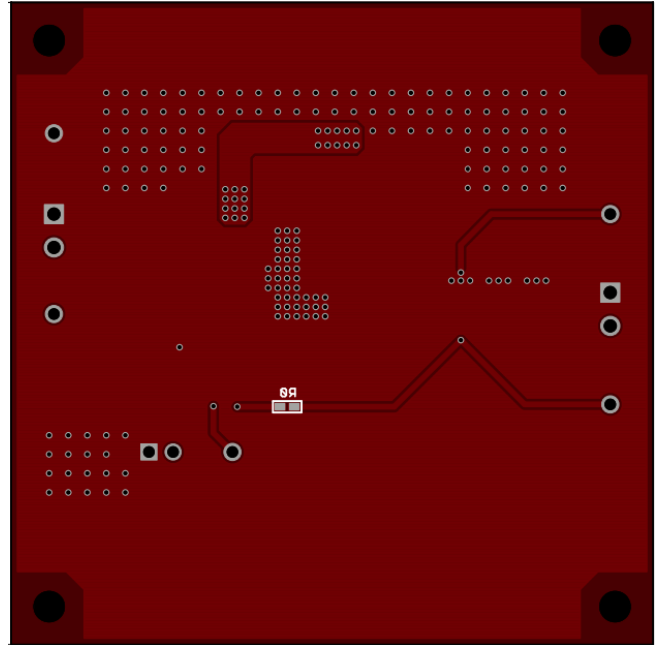

Figure 5. Bottom PCB Image

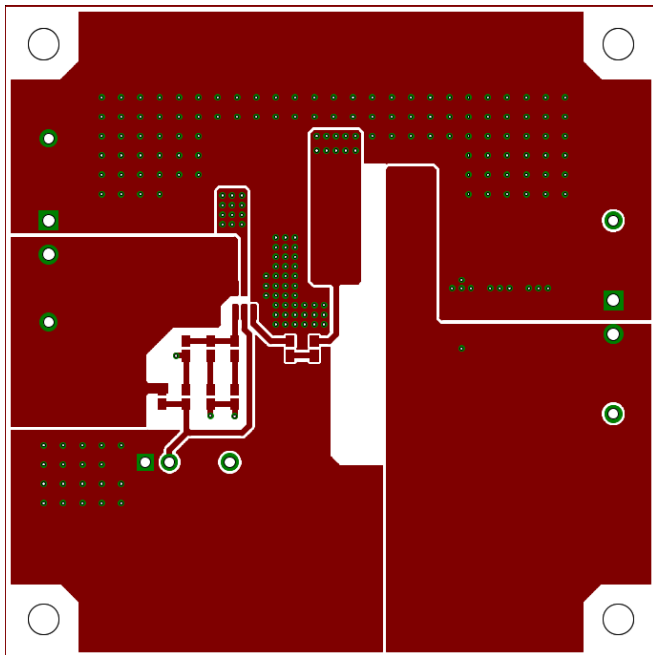

Figure 6. Top Layer Layout

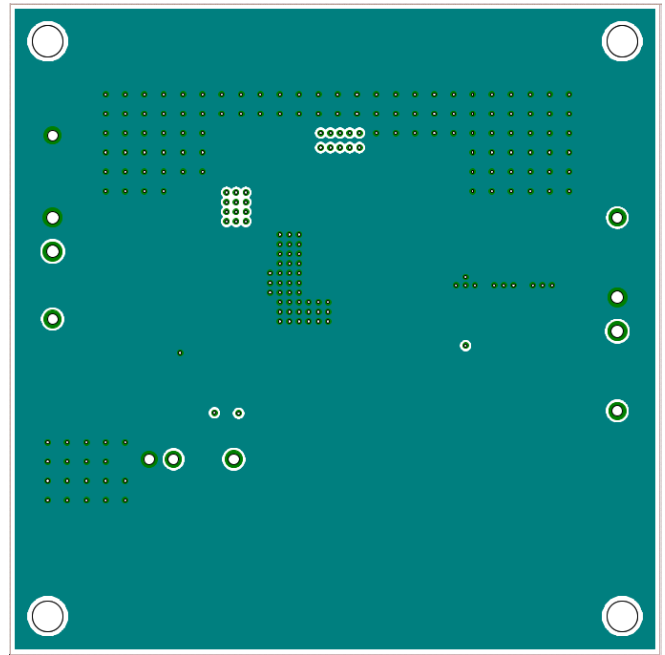

Figure 7. Middle1 Layer Layout

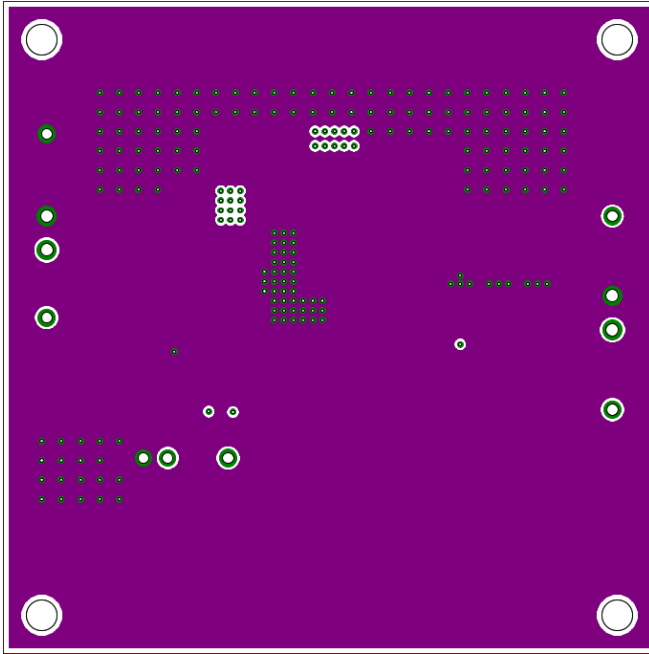

Figure 8. Middle2 Layer Layout

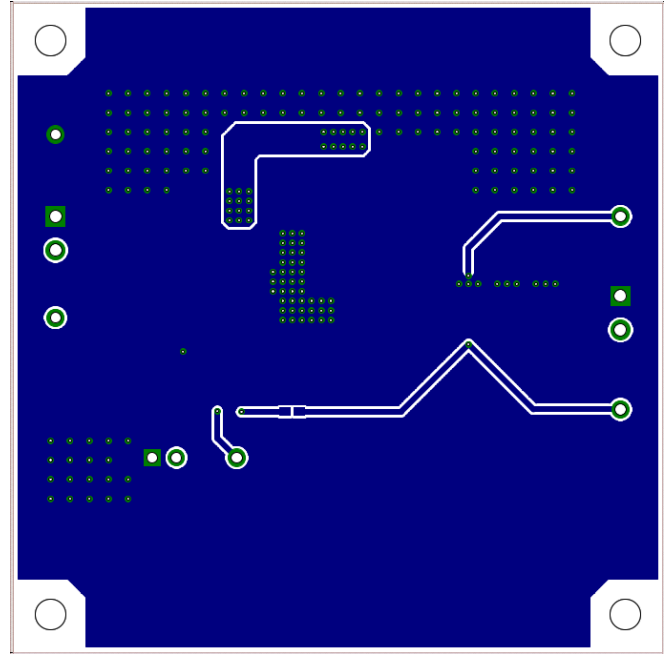

Figure 9. Bottom Layer Layout

Revision History

Date	Revision Number	Description
6. Jul. 2023	001	New release
10. Apr. 2024	002	Add board Input and output conditions to subtitle

Notice

- 1) The information contained in this document is intended to introduce ROHM Group (hereafter referred to as ROHM) products. When using ROHM products, please verify the latest specifications or datasheets before use.
- 2) ROHM products are designed and manufactured for use in general electronic equipment and applications (such as Audio Visual equipment, Office Automation equipment, telecommunication equipment, home appliances, amusement devices, etc.) or specified in the datasheets. Therefore, please contact the ROHM sales representative before using ROHM products in equipment or devices requiring extremely high reliability and whose failure or malfunction may cause danger or injury to human life or body or other serious damage (such as medical equipment, transportation, traffic, aircraft, spacecraft, nuclear power controllers, fuel control, automotive equipment including car accessories, etc. hereafter referred to as Specific Applications). Unless otherwise agreed in writing by ROHM in advance, ROHM shall not be in any way responsible or liable for any damages, expenses, or losses incurred by you or third parties arising from the use of ROHM Products for Specific Applications.
- 3) Electronic components, including semiconductors, can fail or malfunction at a certain rate. Please be sure to implement, at your own responsibilities, adequate safety measures including but not limited to fail-safe design against physical injury, and damage to any property, which a failure or malfunction of products may cause.
- 4) The information contained in this document, including application circuit examples and their constants, is intended to explain the standard operation and usage of ROHM products, and is not intended to guarantee, either explicitly or implicitly, the operation of the product in the actual equipment it will be used. As a result, you are solely responsible for it, and you must exercise your own independent verification and judgment in the use of such information contained in this document. ROHM shall not be in any way responsible or liable for any damages, expenses, or losses incurred by you or third parties arising from the use of such information.
- 5) When exporting ROHM products or technologies described in this document to other countries, you must abide by the procedures and provisions stipulated in all applicable export laws and regulations, such as the Foreign Exchange and Foreign Trade Act and the US Export Administration Regulations, and follow the necessary procedures in accordance with these provisions.
- 6) The technical information and data described in this document, including typical application circuits, are examples only and are not intended to guarantee to be free from infringement of third parties intellectual property or other rights. ROHM does not grant any license, express or implied, to implement, use, or exploit any intellectual property or other rights owned or controlled by ROHM or any third parties with respect to the information contained herein.
- 7) No part of this document may be reprinted or reproduced in any form by any means without the prior written consent of ROHM.
- 8) All information contained in this document is current as of the date of publication and subject to change without notice. Before purchasing or using ROHM products, please confirm the latest information with the ROHM sales representative.
- 9) ROHM does not warrant that the information contained herein is error-free. ROHM shall not be in any way responsible or liable for any damages, expenses, or losses incurred by you or third parties resulting from errors contained in this document.



Thank you for your accessing to ROHM product informations.
More detail product informations and catalogs are available, please contact us.

ROHM Customer Support System

<https://www.rohm.com/contactus>