

Switching Regulator Series
Isolated Flyback DC/DC Converter
BD7J200EFJ-LB EVK
BD7J200EFJ-EVK-001 (48V→5V, 2.4A)

<High Voltage Safety Precautions>

◇ Read all safety precautions before use

Please note that this document covers only the **BD7J200EFJ-LB** evaluation board (BD7J200EFJ-EVK-001) and its functions. For additional information, please refer to the datasheet.

To ensure safe operation, please carefully read all precautions before handling the evaluation board



Depending on the configuration of the board and voltages used,

Potentially lethal voltages may be generated.

Therefore, please make sure to read and observe all safety precautions described in the red box below.

Before Use

- [1] Verify that the parts/components are not damaged or missing (i.e. due to the drops).
- [2] Check that there are no conductive foreign objects on the board.
- [3] Be careful when performing soldering on the module and/or evaluation board to ensure that solder splash does not occur.
- [4] Check that there is no condensation or water droplets on the circuit board.

During Use

- [5] Be careful to not allow conductive objects to come into contact with the board.
- [6] **Brief accidental contact or even bringing your hand close to the board may result in discharge and lead to severe injury or death.**

Therefore, DO NOT touch the board with your bare hands or bring them too close to the board.

In addition, as mentioned above please exercise extreme caution when using conductive tools such as tweezers and screwdrivers.

- [7] If used under conditions beyond its rated voltage, it may cause defects such as short-circuit or, depending on the circumstances, explosion or other permanent damages.
- [8] Be sure to wear insulated gloves when handling is required during operation.

After Use

- [9] The ROHM Evaluation Board contains the circuits which store the high voltage. Since it stores the charges even after the connected power circuits are cut, please discharge the electricity after using it, and please deal with it after confirming such electric discharge.
- [10] Protect against electric shocks by wearing insulated gloves when handling.

This evaluation board is intended for use only in research and development facilities and should be handled **only by qualified personnel familiar with all safety and operating procedures.**

We recommend carrying out operation in a safe environment that includes the use of high voltage signage at all entrances, safety interlocks, and protective glasses.

Switching Regulator Series

Isolated Flyback DC/DC Converter BD7J200EFJ-LB EVK

BD7J200EFJ-EVK-001 (48V→5V, 2.4A)

BD7J200EFJ-EVK-001 delivers an output 5 volts from an input 48 volts using BD7J200EFJ-LB, Isolated Flyback DC/DC converter integrated circuit, with output current rating of maximum 2.4A.

Performance specification

These are representative values, and it is not a guaranteed against the characteristics.

$V_{IN} = 48V$, $V_{OUT} = 5V$, unless otherwise specified.

Parameter	Min	Typ	Max	Units	Conditions
Input Voltage		48.0		V	
Output Voltage		5.0		V	R4=2k Ω , R5=82.5k Ω
Output Current Range	150		2400	mA	Maximum Output Power: 12W
Operating Frequency		400		kHz	
Maximum Efficiency		73		%	$I_o = 2400mA$

EVK

PCB size: 70mm×50mm×1.6mm

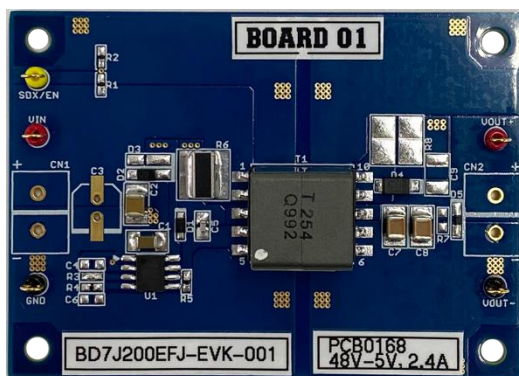

Figure 1. BD7J200EFJ-EVK-001

Top View

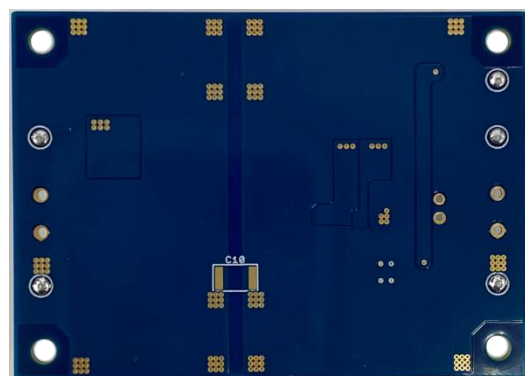

Figure 2. BD7J200EFJ-EVK-001

Bottom View

Operation Procedures

1. Necessary equipments
 - (1) DC power-supply capable of supplying 48V / 0.5A
 - (2) Maximum 2.4A load
 - (3) DC voltmeter
2. Connecting the equipments (as shown in Figure 3)
 - (1) Preset DC power-supply to 48V and turn off.
 - (2) Set the load less than 2.4A and disable.
 - (3) Connect the power-supply to VIN and GND pins with a pair of wire.
 - (4) Connect the load to VOUT+ and VOUT- pins with a pair of wire.
 - (5) Connect the voltmeter1 to VIN and GND pins to measure input voltage.
 - (6) Connect the voltmeter2 to VOUT+ and VOUT- pins to measure output voltage.
 - (7) Turn on the power supply.
 - (8) Check if the value of voltmeter2 is 5V.
 - (9) Enable the load.

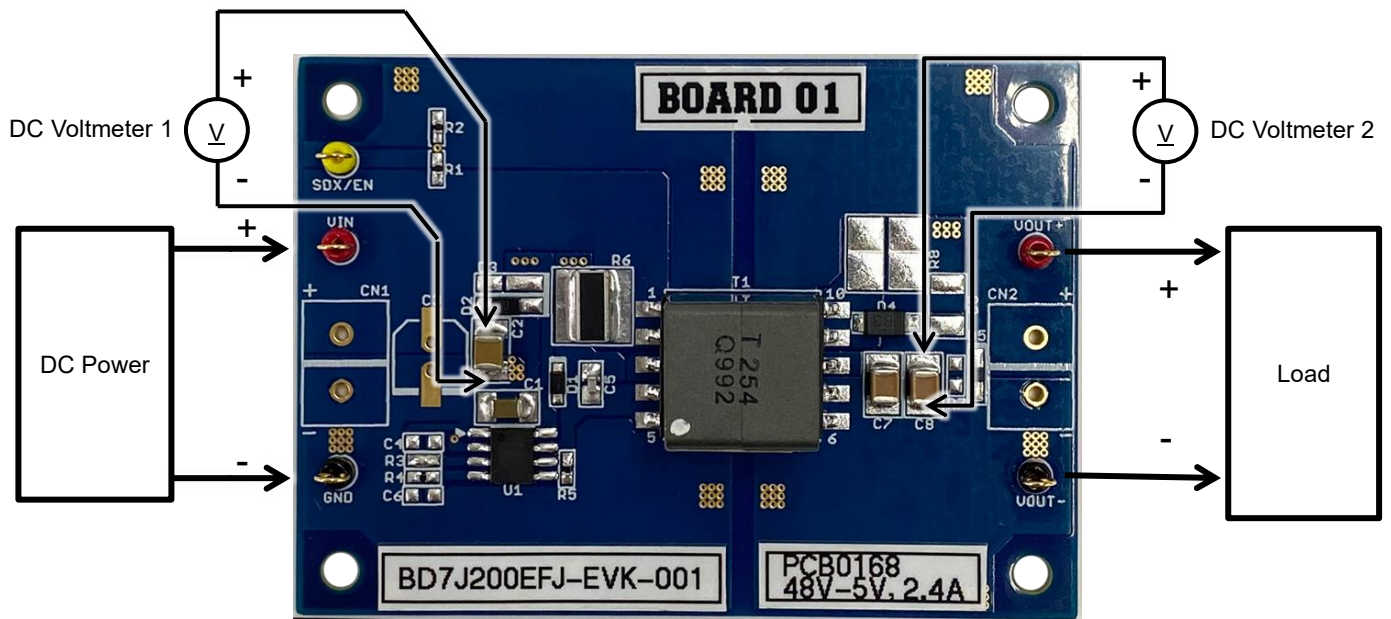

Figure 3. Connection Diagram

Circuit Diagram

V_{IN} = 48V, V_{OUT} = 5V

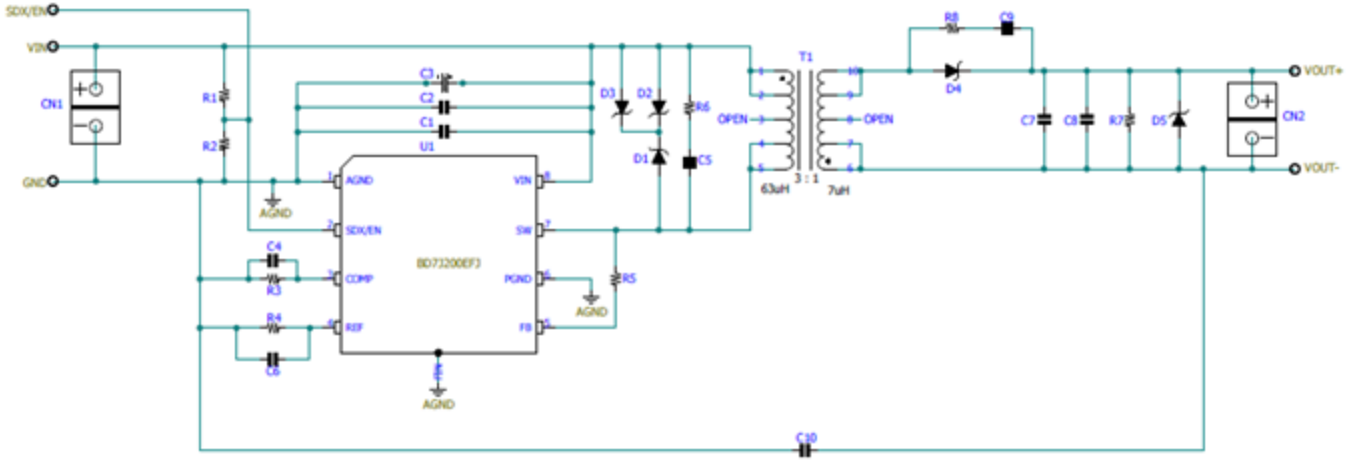

Figure 4. BD7J200EFJ-EVK-001 Circuit Diagram

Bill of Materials

Table 1. Bill of Materials

No.	Value	Description	Size	Part Number / Series	Manufacturer
C1	1μF	Capacitor, Chip, 100V, X7R	3216	GRM31CR72A105KA01	MURATA
C2	10μF	Capacitor, Chip, 100V, X7S	3225	GRM32EC72A106KE05	MURATA
C3	-	Notinstalled	-	-	-
C4	-	Notinstalled	-	-	-
C5	100pF	Capacitor, Chip, 100V, C0G	1608	GCM1885C2A101JA16	MURATA
C6	-	Notinstalled	-	-	-
C7	47μF	Capacitor, Chip, 10V, X7R	3225	GRM32ER71A476KE15	MURATA
C8	47μF	Capacitor, Chip, 10V, X7R	3225	GRM32ER71A476KE15	MURATA
C9	-	Notinstalled	-	-	-
C10	-	Notinstalled	-	-	-
D1	1A/60V	Diode, Schottky	1608	RB160VAM-60	ROHM
D2	Vz=36.0~	Diode, Zener, Vz=36.0~40.0V	3516	KDZV36B	ROHM
D3	-	Notinstalled	-	-	-
D4	5A/20V	Diode, Schottky	4725	RSX501LAM20	ROHM
D5	Vz=5.45V~	Diode, Zener, Vz=5.49~5.73V	1005	EDZV5.6B	ROHM
R1	1MΩ	Resistor, Chip, 1/16W, 1%	1005	MCR01MZPF1004	ROHM
R2	68kΩ	Resistor, Chip, 1/16W, 1%	1005	MCR01MZPF6802	ROHM
R3	-	Short	-	-	-
R4	2kΩ	Resistor, Chip, 1/16W, 1%	1005	MCR01MZPF2001	ROHM
R5	82.5kΩ	Resistor, Chip, 1/16W, 1%	1005	MCR01MZPF8252	ROHM
R6	1kΩ	Resistor, Chip, 2W, 5%	3264	LTR100JZPJ102	ROHM
R7	-	Notinstalled	-	-	-
R8	-	Notinstalled	-	-	-
T1	72μH	Transformer, Np:Ns=6:1, ±20%	13.5 x 18.0 x 12.5mm	CEP1311F-4805121R	sumida
U1	BD7J200EFJ	I.C. BD7J200EFJ, HTSOP-J8	4.90x6.00x1.00mm	BD7J200EFJ	ROHM

Board Layout

EVK PCB information

Number of Layers	Material	Board Size
4	FR-4	70mm x 50mm x 1.6mmt

The following are layers of the BD7J200EFJ-EVK-001

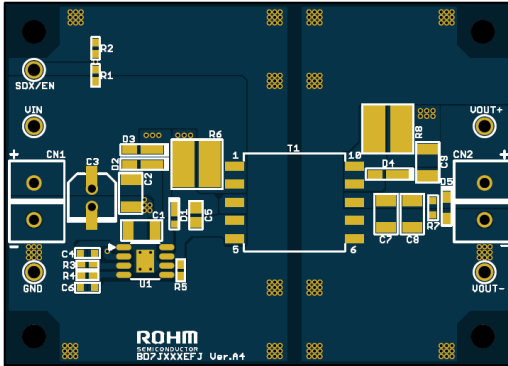

Figure 5. Top silk screen, layout
(Top View)

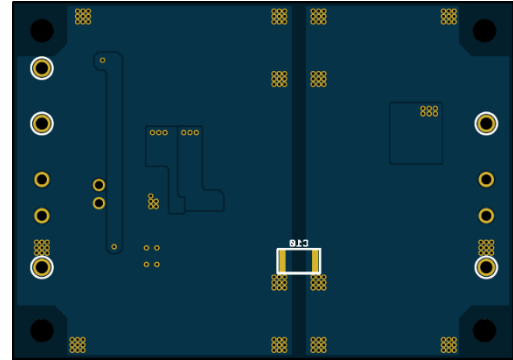

Figure 6. Bottom silk screen, layout
(Top View)

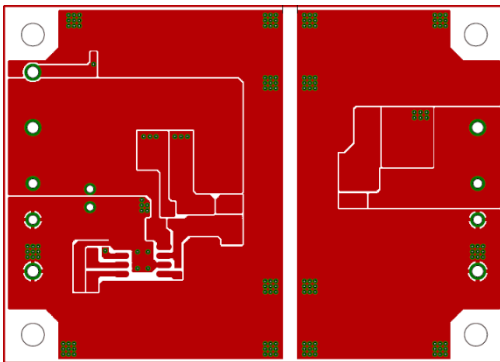

Figure 7. Top Layer layout
(Top View)

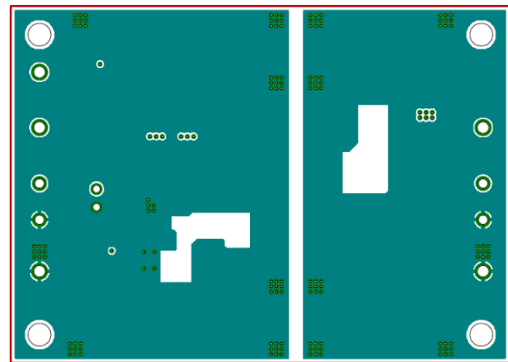

Figure 8. Middle Layer1 layout
(Top View)

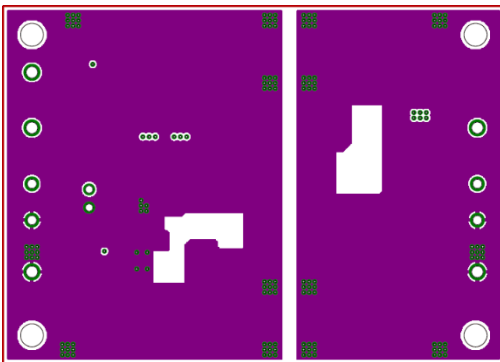

Figure 9. Middle Layer2 Layout
(Top View)

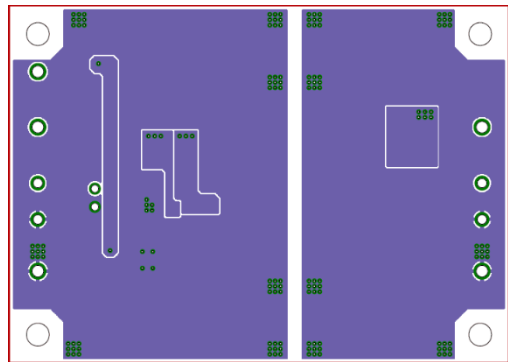

Figure 10. Bottom Layer Layout
(Top View)

Reference Application Data

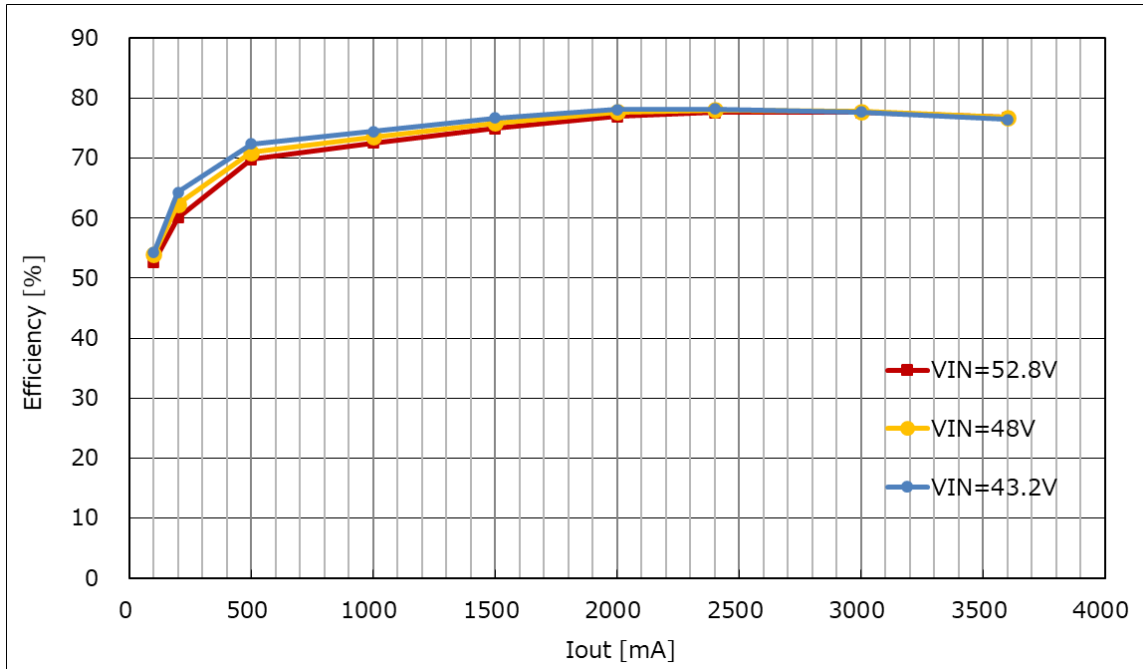

Figure 11. Power Conversion Efficiency vs Output Current

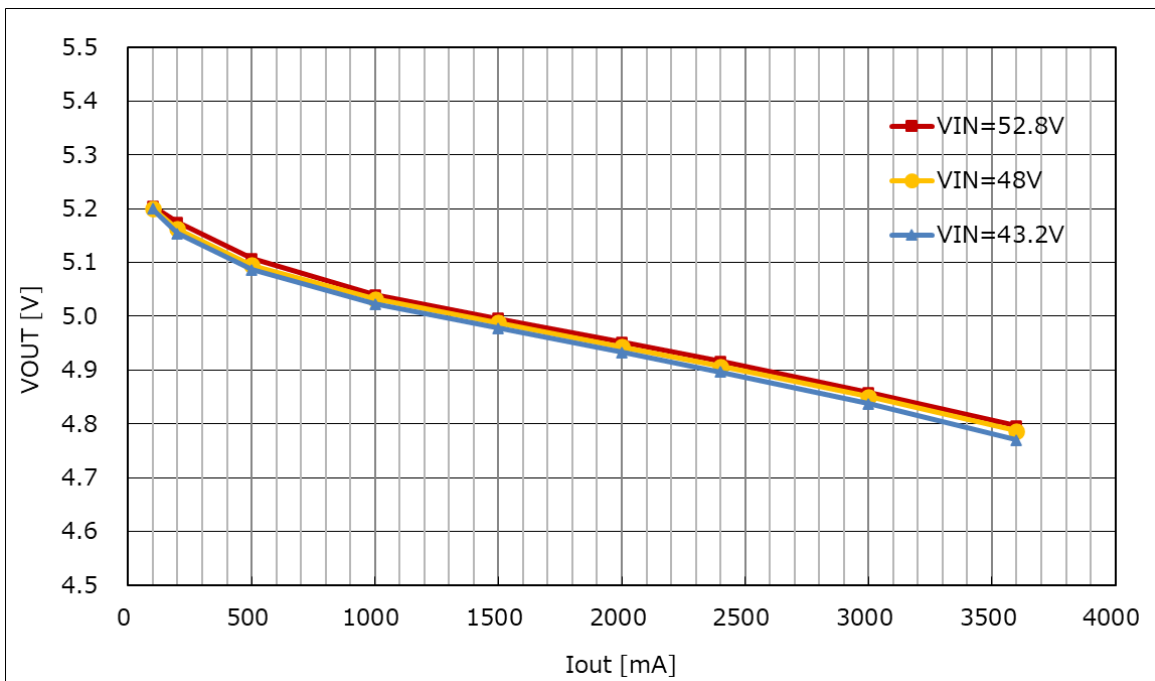

Figure 12. Load Regulation

Revision History

Date	Revision Number	Description
9. Sep. 2021	001	Initial release

Notes

- 1) The information contained herein is subject to change without notice.
- 2) Before you use our Products, please contact our sales representative and verify the latest specifications :
- 3) Although ROHM is continuously working to improve product reliability and quality, semiconductors can break down and malfunction due to various factors.
Therefore, in order to prevent personal injury or fire arising from failure, please take safety measures such as complying with the derating characteristics, implementing redundant and fire prevention designs, and utilizing backups and fail-safe procedures. ROHM shall have no responsibility for any damages arising out of the use of our Products beyond the rating specified by ROHM.
- 4) Examples of application circuits, circuit constants and any other information contained herein are provided only to illustrate the standard usage and operations of the Products. The peripheral conditions must be taken into account when designing circuits for mass production.
- 5) The technical information specified herein is intended only to show the typical functions of and examples of application circuits for the Products. ROHM does not grant you, explicitly or implicitly, any license to use or exercise intellectual property or other rights held by ROHM or any other parties. ROHM shall have no responsibility whatsoever for any dispute arising out of the use of such technical information.
- 6) The Products specified in this document are not designed to be radiation tolerant.
- 7) For use of our Products in applications requiring a high degree of reliability (as exemplified below), please contact and consult with a ROHM representative : transportation equipment (i.e. cars, ships, trains), primary communication equipment, traffic lights, fire/crime prevention, safety equipment, medical systems, servers, solar cells, and power transmission systems.
- 8) Do not use our Products in applications requiring extremely high reliability, such as aerospace equipment, nuclear power control systems, and submarine repeaters.
- 9) ROHM shall have no responsibility for any damages or injury arising from non-compliance with the recommended usage conditions and specifications contained herein.
- 10) ROHM has used reasonable care to ensure the accuracy of the information contained in this document. However, ROHM does not warrants that such information is error-free, and ROHM shall have no responsibility for any damages arising from any inaccuracy or misprint of such information.
- 11) Please use the Products in accordance with any applicable environmental laws and regulations, such as the RoHS Directive. For more details, including RoHS compatibility, please contact a ROHM sales office. ROHM shall have no responsibility for any damages or losses resulting non-compliance with any applicable laws or regulations.
- 12) When providing our Products and technologies contained in this document to other countries, you must abide by the procedures and provisions stipulated in all applicable export laws and regulations, including without limitation the US Export Administration Regulations and the Foreign Exchange and Foreign Trade Act.
- 13) This document, in part or in whole, may not be reprinted or reproduced without prior consent of ROHM.



Thank you for your accessing to ROHM product informations.
More detail product informations and catalogs are available, please contact us.

ROHM Customer Support System

<http://www.rohm.com/contact/>