

## Linear Regulator Series

# Thermal Resistance Data: SSOP5

## BD9xxN1G-C Series

This application note provides the thermal resistance data of the SSOP5 package used for the thermal design of the BD9xxN1G-C series linear regulator IC.

### Product Summary

Model name: BD9xxN1G-C series

Package name: SSOP5

Function: Linear regulator (LDO) IC

See Datasheet for more details.

### Package

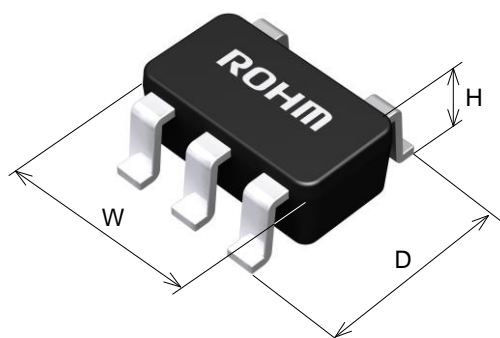

SSOP5

W (typ) D (typ) H (max)  
2.9 mm × 2.8 mm × 1.25 mm

### Measurement environment

Content	Standard
Measurement environment	JEDEC STANDARD JESD51-2A (Still Air)
Measurement board standard	JEDEC STANDARD JESD51-3 JESD51-7

### Thermal resistance

Configuration	$\theta_{JA}$ (°C/W)	$\Psi_{JT}$ (°C/W)
1-layer	271.3	46
2-layers	194.2	39
4-layers	146.7	37

$\theta_{JA}$ : Thermal resistance between  
junction temperature  $T_J$  -  
ambient temperature  $T_A$

$\Psi_{JT}$ : Thermal characterization parameter between  
Junction temperature  $T_J$  -  
package surface center temperature  $T_T$

Note: The thermal resistances and thermal characterization parameters in this application note are based on measurement under a JEDEC environment and may not always be consistent with the values for actual equipment. It is necessary to consider variations in the values due to the PCB characteristics, PCB layout, parts layout, chassis shape, surrounding environment, and so on.

PCB specification, 1 layer (1s)

Conforms to JEDEC standard JESD51-3

Item	Value
Board thickness	1.57 mm
Board outline dimensions	76.2 mm × 114.3 mm
Board material	FR-4
Trace thickness (Finished thickness)	70 μm (2 oz)
Lead width	0.254 mm
Copper foil area	Footprint [ 50 mm <sup>2</sup> to 600 mm <sup>2</sup> ]

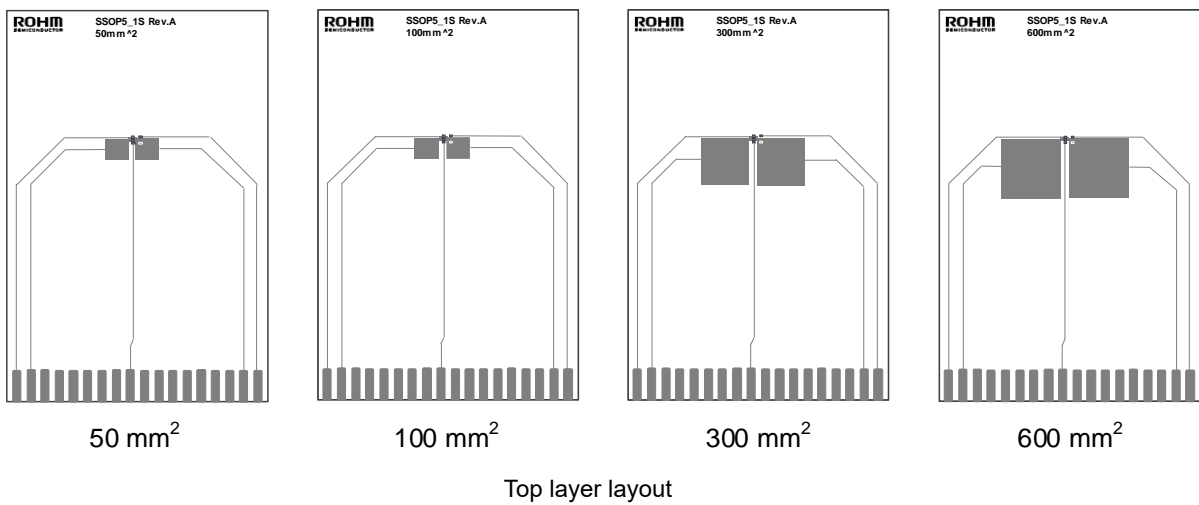
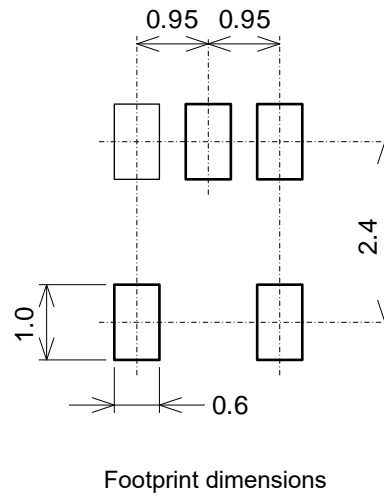
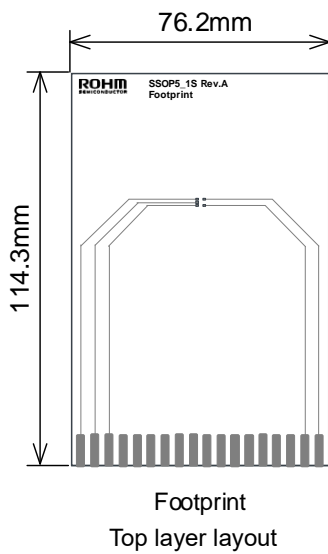
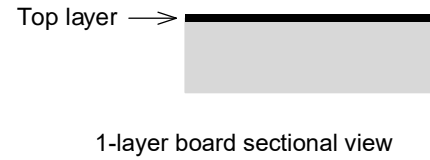

PCB specification, 2-layers

Conforms to JEDEC standard JESD51-7

Item		Value
Board thickness		1.60 mm
Board outline dimensions		76.2 mm × 114.3 mm
Board material		FR-4
Trace thickness (Finished thickness)	Top	70 μm (2 oz)
	Bottom	70 μm (2 oz)
Lead width		0.254 mm
Copper foil area	Top	Footprint 5505 mm <sup>2</sup> (74.2 mm × 74.2 mm) [ 50 mm <sup>2</sup> to 3000 mm <sup>2</sup> ]
	Bottom	

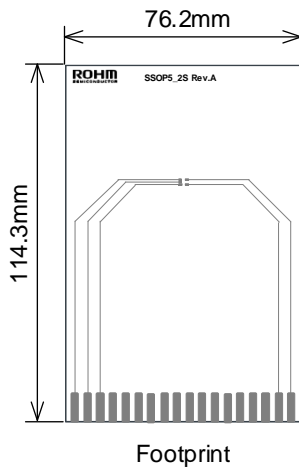
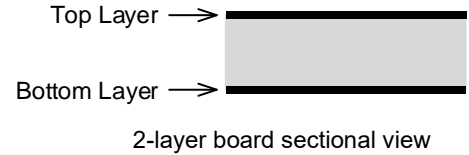

Top layer layout



Bottom layer layout

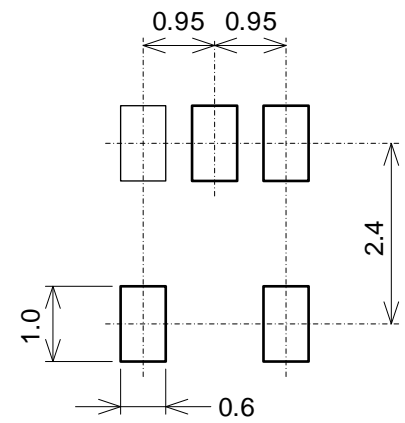

Footprint dimensions

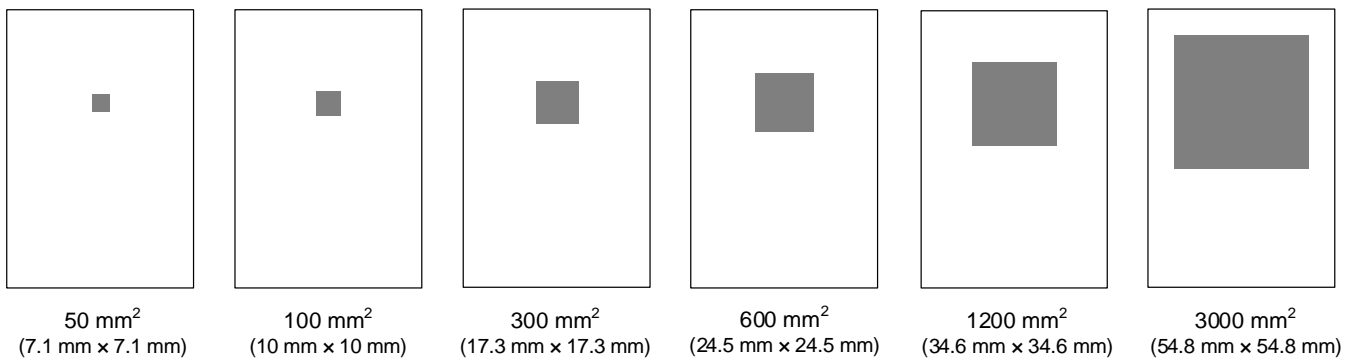

Bottom layer layout

**PCB specification, 4-layers (2s2p)**

Conforms to JEDEC standard JESD51-7

Item		Value
Board thickness		1.60 mm
Board outline dimensions		76.2 mm × 114.3 mm
Board material		FR-4
Trace thickness (Finished thickness)	Top	70 μm (2 oz)
	Middle 1	35 μm (1 oz)
	Middle 2	35 μm (1 oz)
	Bottom	70 μm (2 oz)
Lead width		0.254 mm
Copper foil area	Top	Footprint
	Middle 1	5505 mm <sup>2</sup> (74.2 mm × 74.2 mm)
	Middle 2	5505 mm <sup>2</sup> (74.2 mm × 74.2 mm)
	Bottom	5505 mm <sup>2</sup> (74.2 mm × 74.2 mm)

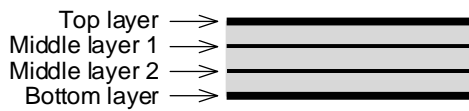

4-layer board sectional view

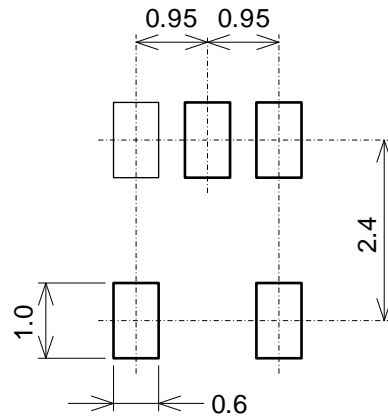

Footprint dimensions

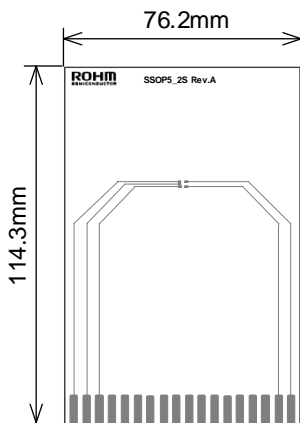

Footprint

Top layer layout



5505 mm<sup>2</sup>  
(74.2 mm × 74.2 mm)

Middle 1 layer layout



5505 mm<sup>2</sup>  
(74.2 mm × 74.2 mm)

Middle 2 layer layout

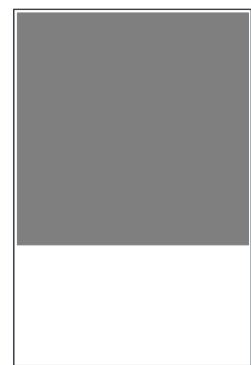

5505 mm<sup>2</sup>  
(74.2 mm × 74.2 mm)

Bottom layer layout

Thermal resistance data, 1-layer (1s)

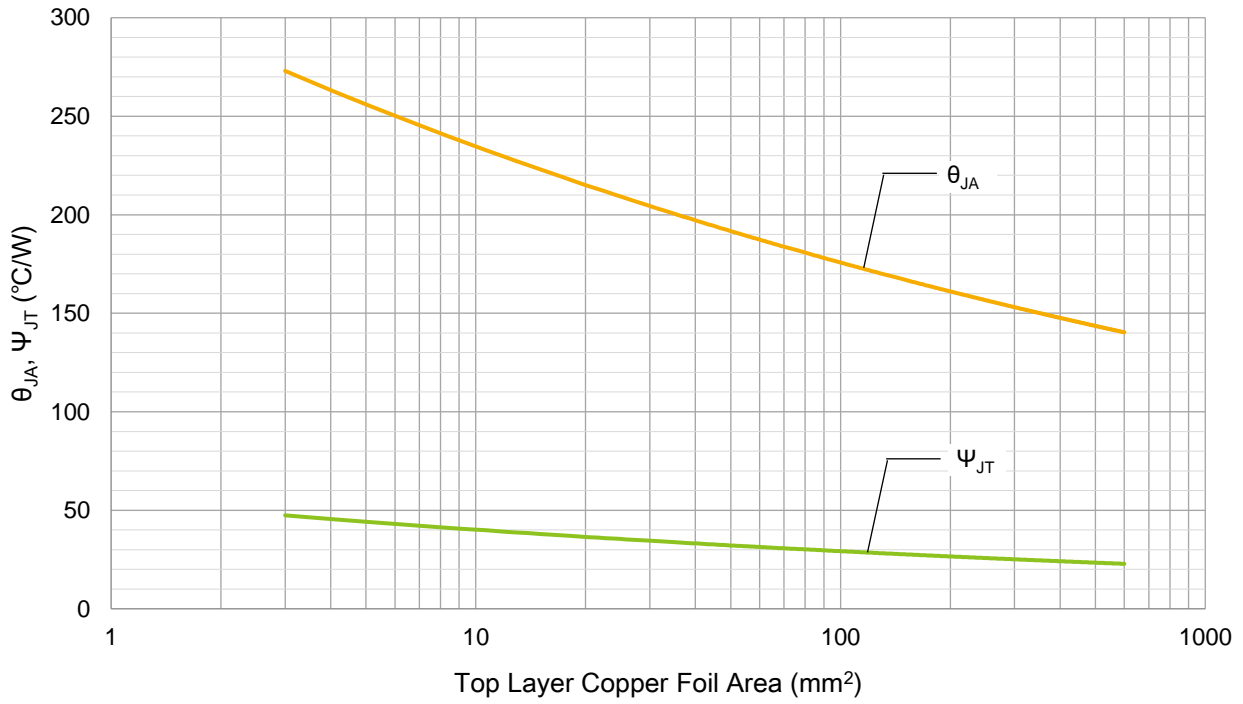

Figure 1.  $\theta_{JA}$ ,  $\psi_{JT}$  vs. Top Layer Copper Foil Area

Thermal resistance data, 2-layers

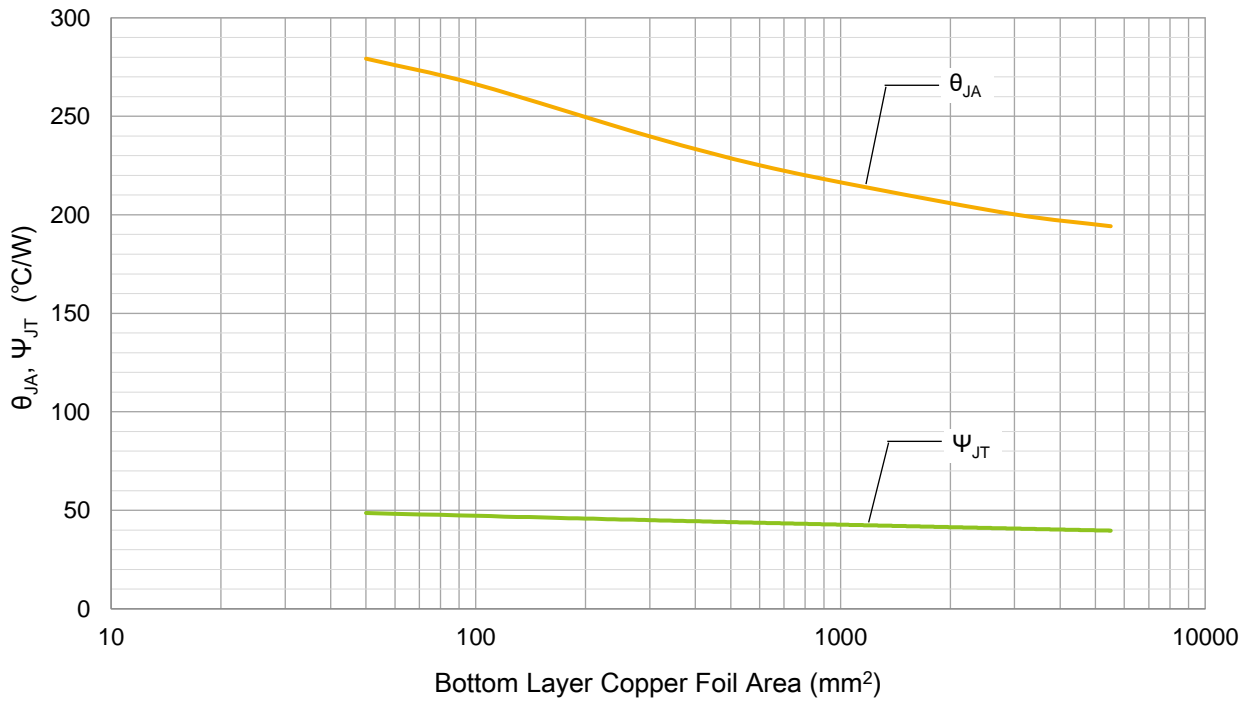
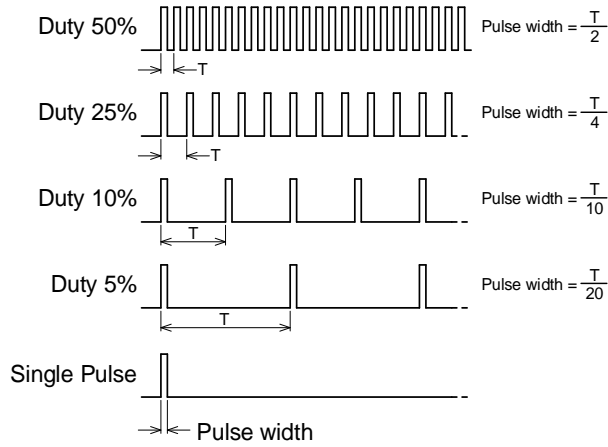

Figure 2.  $\theta_{JA}$ ,  $\psi_{JT}$  vs. Bottom Layer Copper Foil Area

### Transient thermal resistance

Conforms to JEDEC standard JESD51

X axis: The length of time electrical power is applied to the device-under-test



Y axis: Transient thermal resistance

### Transient thermal resistance data, 1-layer (1s)

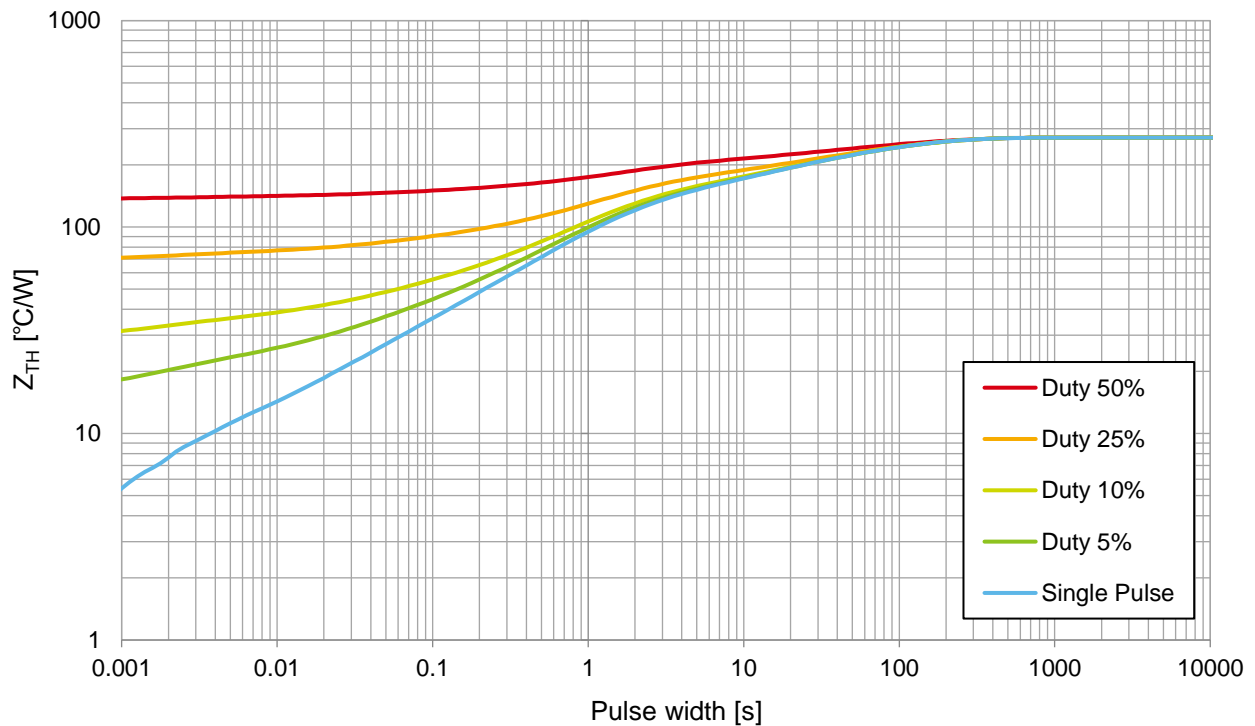

Figure 3. Transient thermal resistance, 1 layer, Copper foil surface area Footprint

Transient thermal resistance data, 1-layer (1s), continued

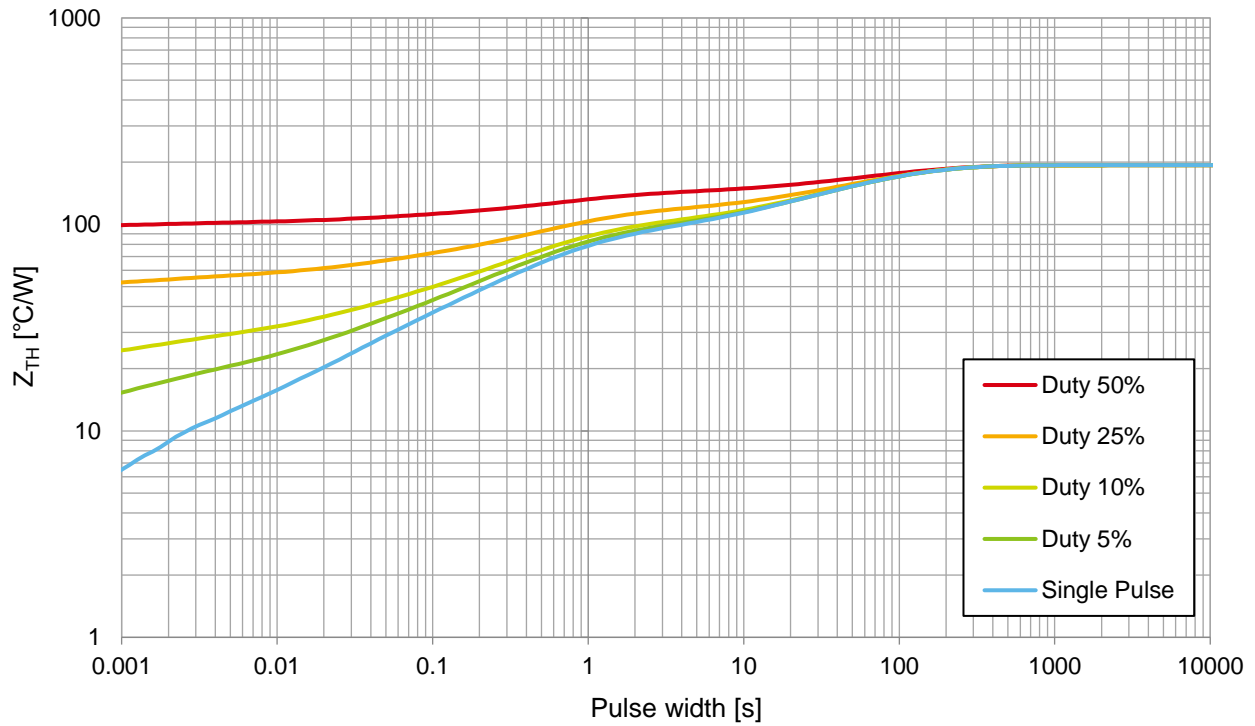

Figure 4. Transient thermal resistance, 1-layer, Copper foil surface area 50 mm<sup>2</sup>

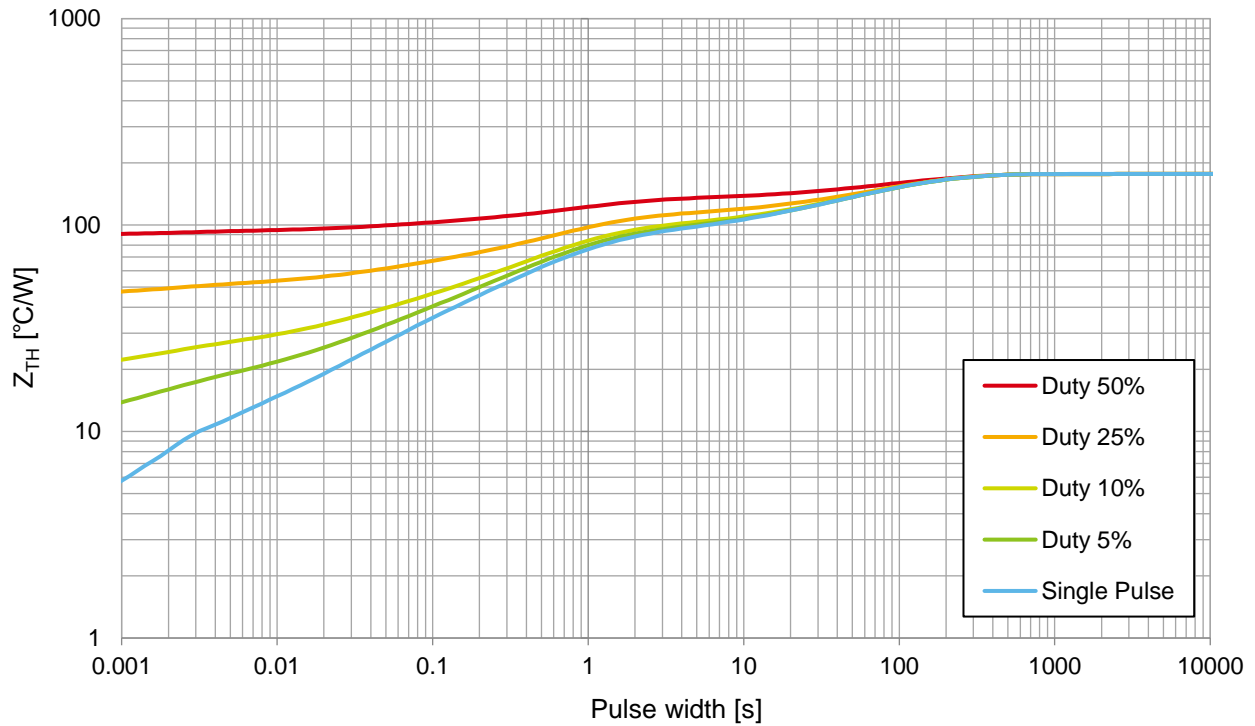

Figure 5. Transient thermal resistance, 1-layer, Copper foil surface area 100 mm<sup>2</sup>

Transient thermal resistance data, 1-layer (1s), continued

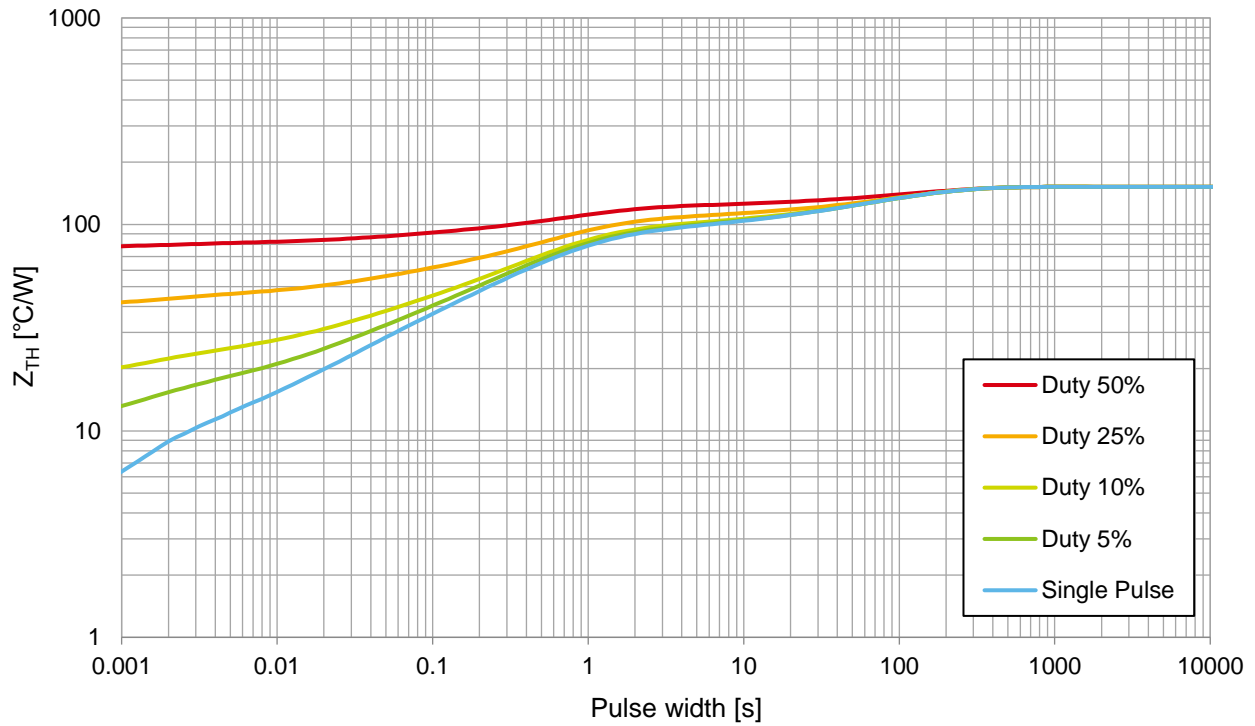

Figure 6. Transient thermal resistance, 1-layer, Copper foil surface area 300 mm²

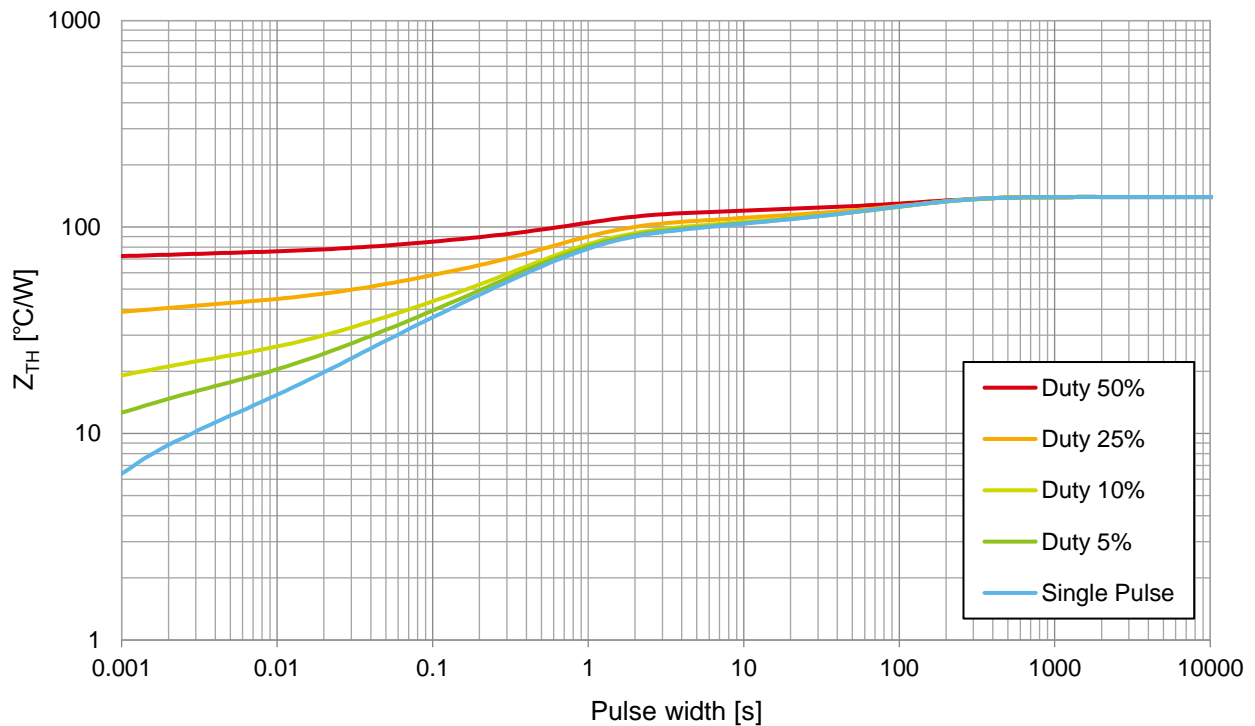

Figure 7. Transient thermal resistance, 1-layer, Copper foil surface area 600 mm²



Transient thermal resistance data, 2-layers

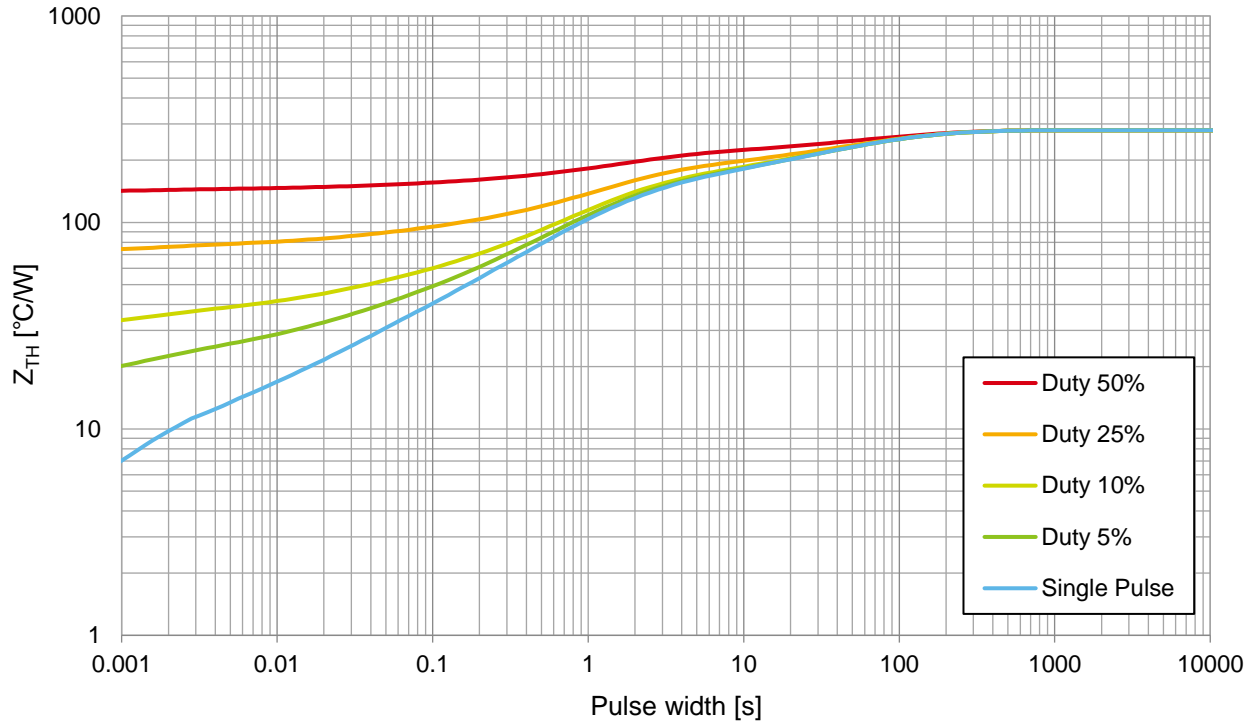

Figure 8. Transient thermal resistance, 2-layers, Copper foil bottom area 50 mm<sup>2</sup>

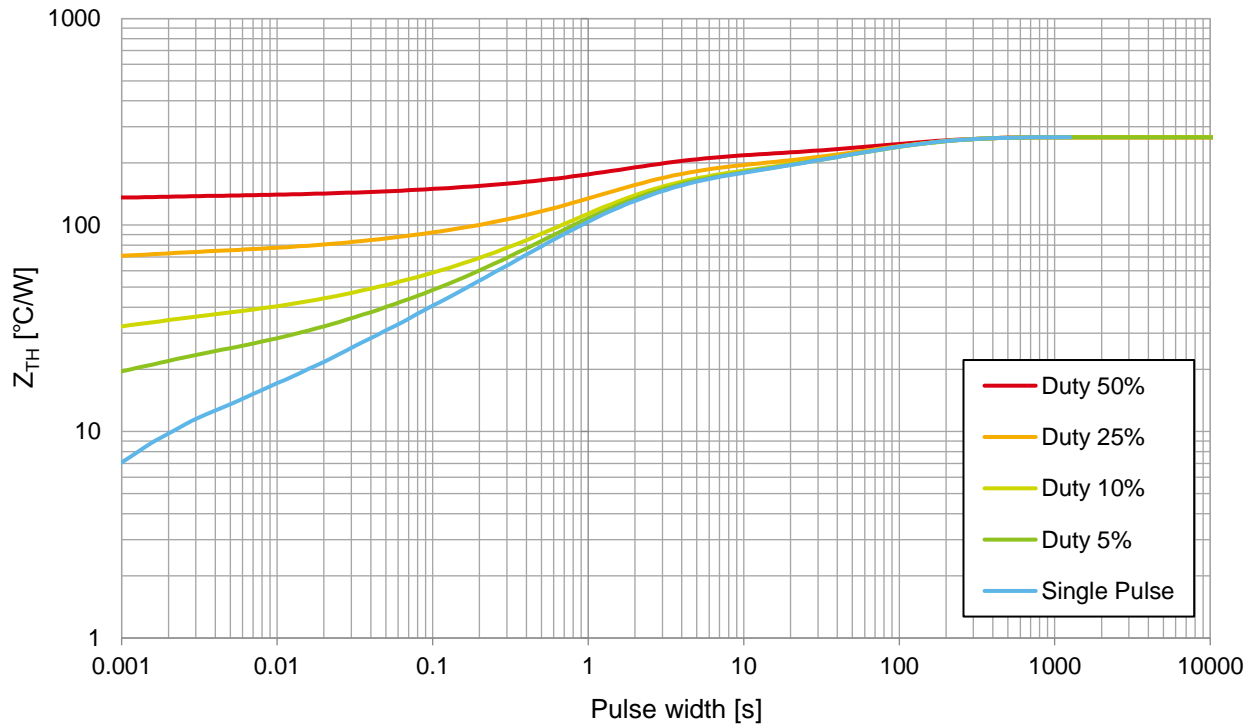

Figure 9. Transient thermal resistance, 2-layers, Copper foil bottom area 100 mm<sup>2</sup>

Transient thermal resistance data, 2 layers, continued

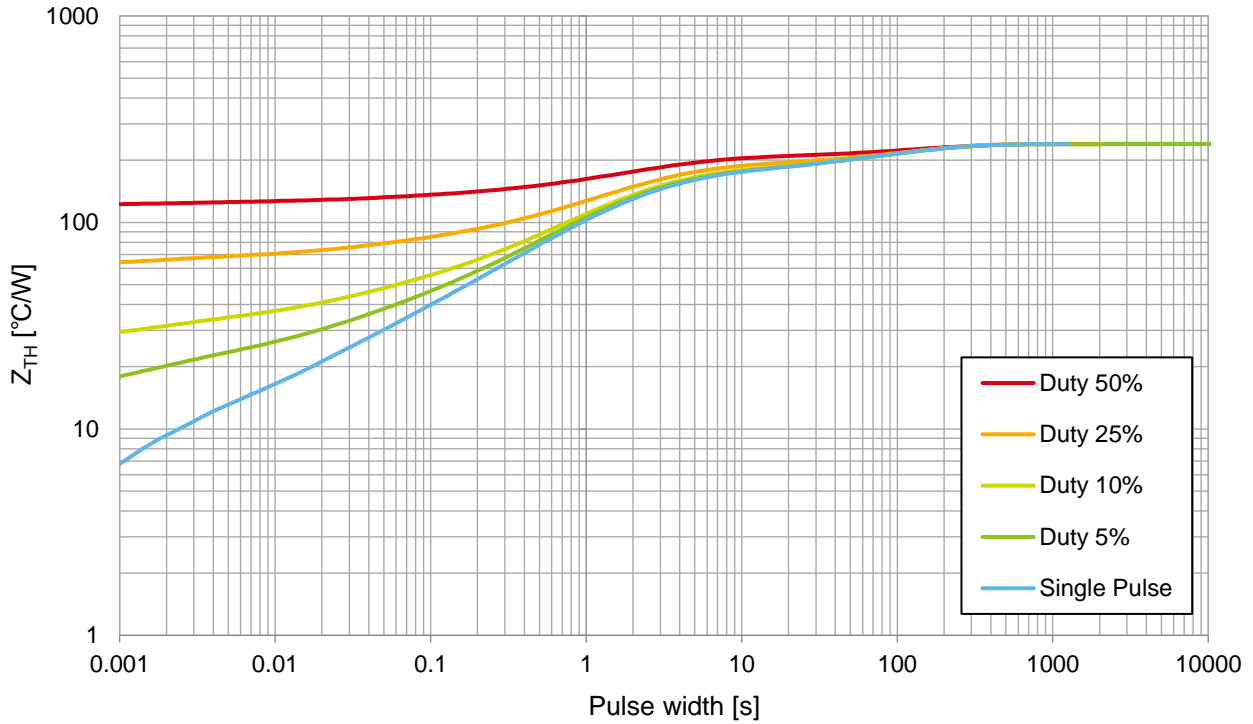

Figure 10. Transient thermal resistance, 2-layers, Copper foil bottom area 300 mm<sup>2</sup>

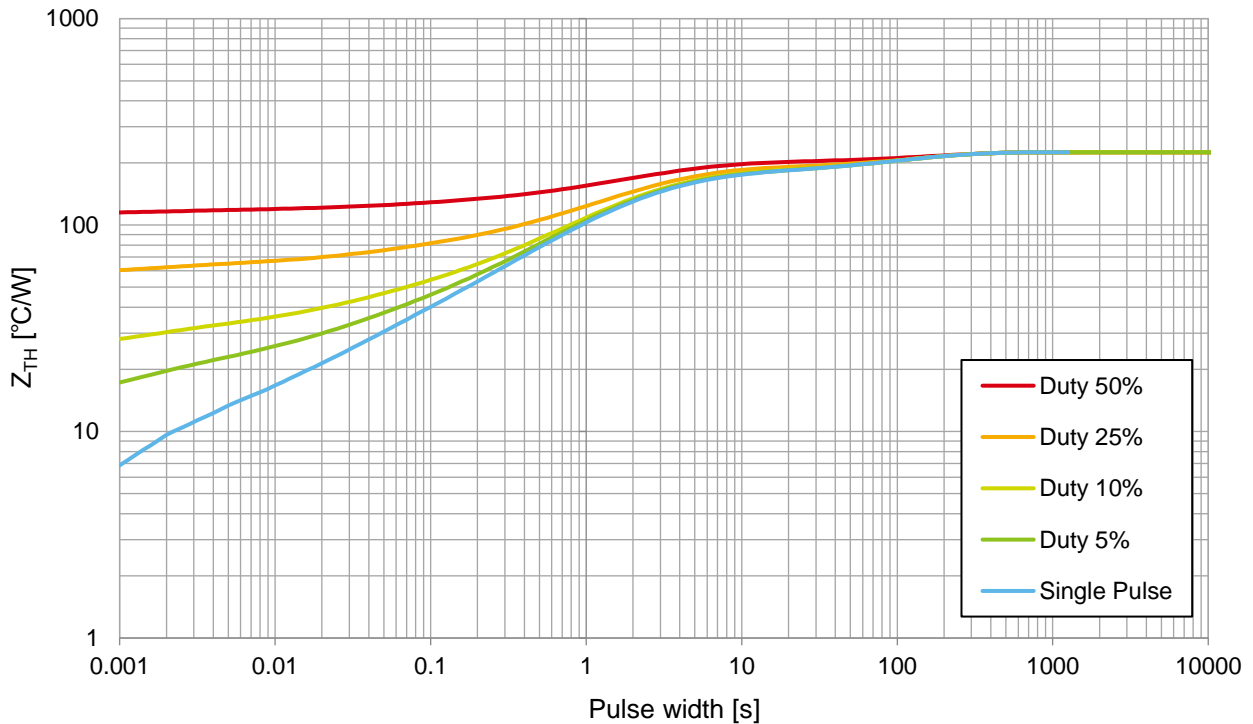

Figure 11. Transient thermal resistance, 2-layers, Copper foil bottom area 600 mm<sup>2</sup>

Transient thermal resistance data, 2-layers, continued

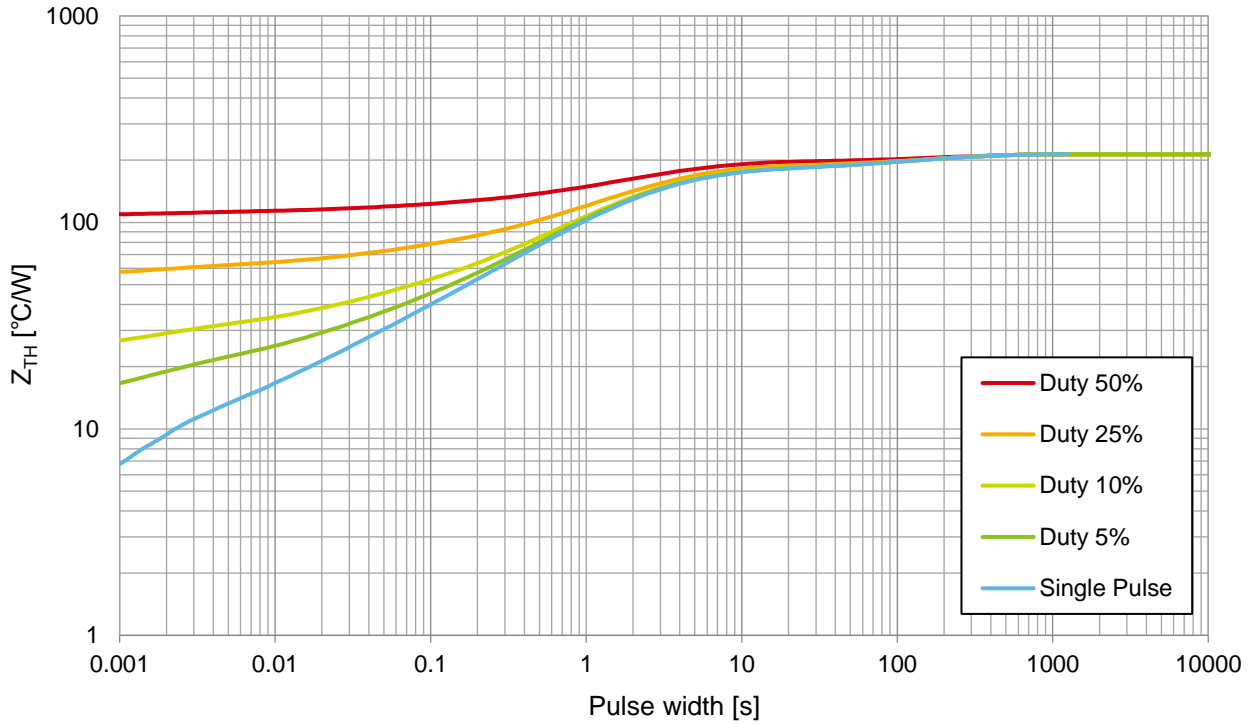

Figure 12. Transient thermal resistance, 2-layers, Copper foil bottom area 1200 mm<sup>2</sup>

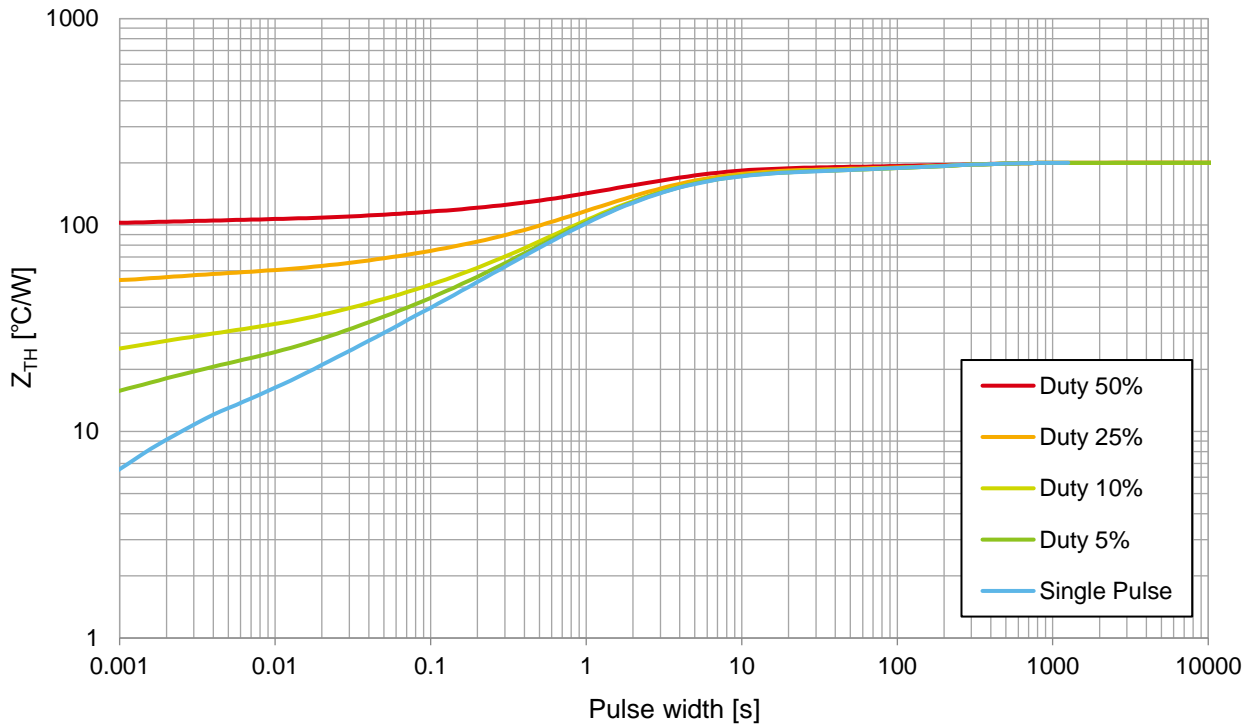

Figure 13. Transient thermal resistance, 2-layers, Copper foil bottom area 3000 mm<sup>2</sup>

Transient thermal resistance data, 2-layers, continued

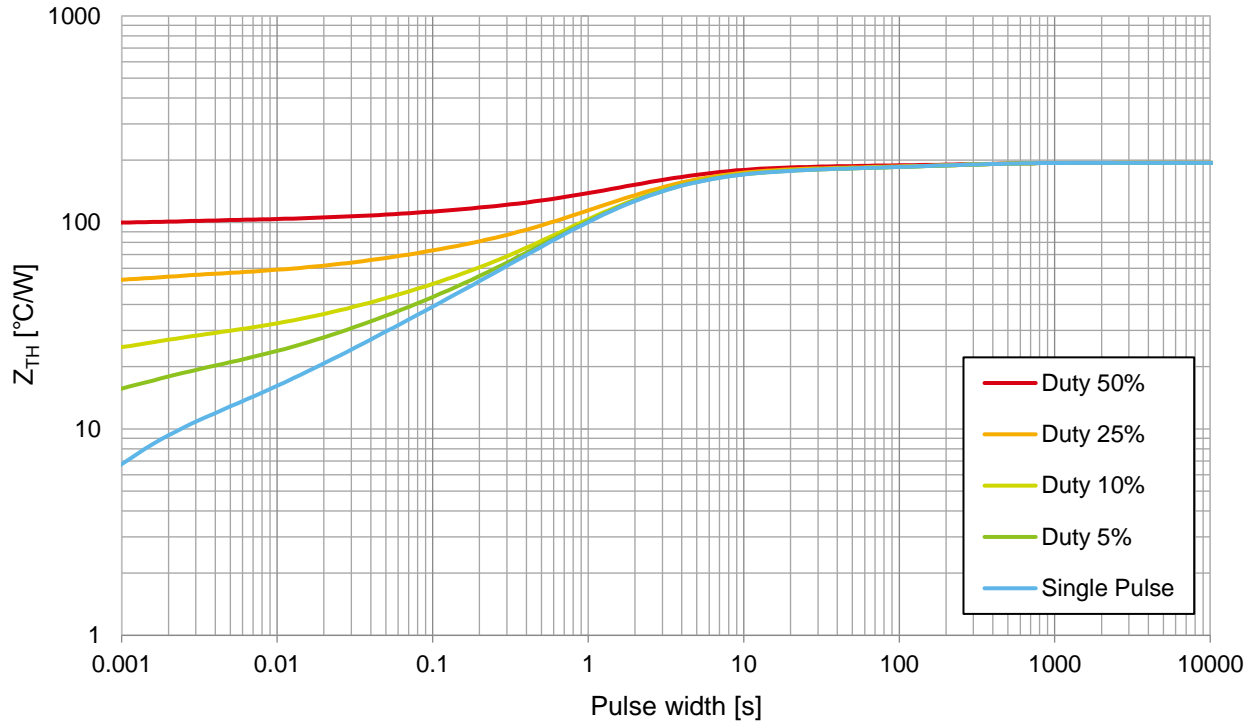

Figure 14. Transient thermal resistance, 2-layers, Copper foil bottom area 5505 mm<sup>2</sup>

Transient thermal resistance data, 4-layers (2s2p)

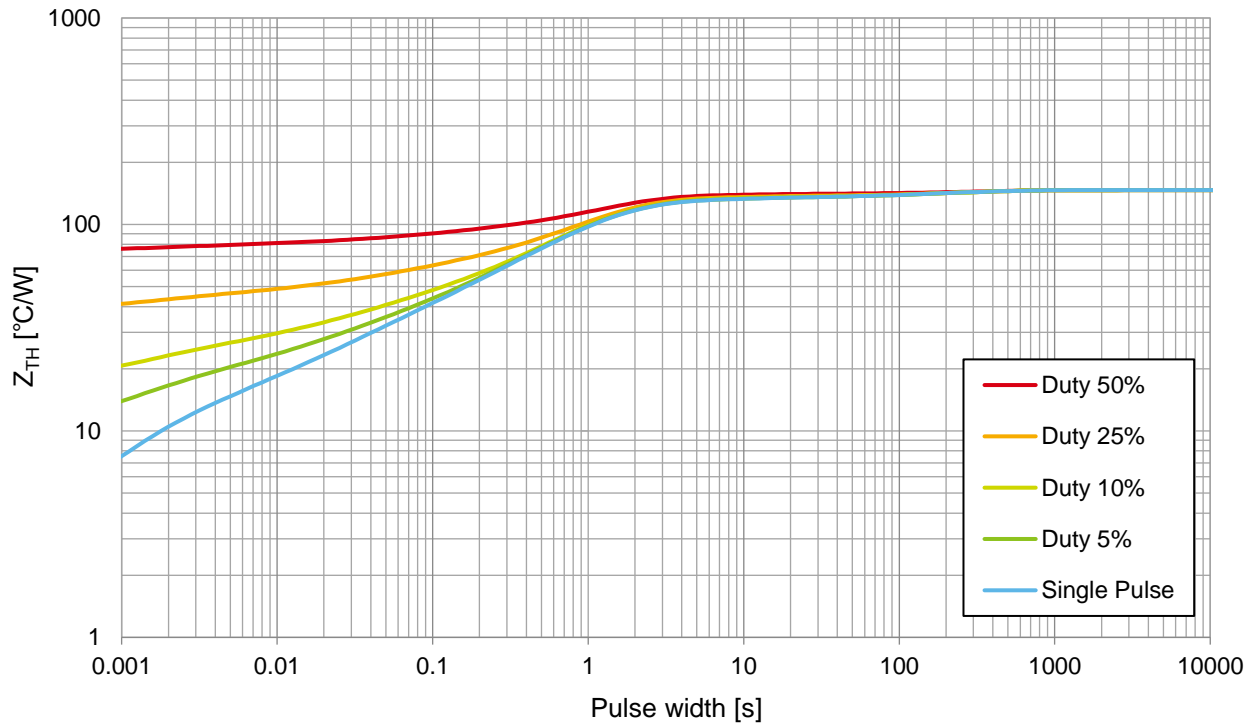

Figure 15. Transient thermal resistance, 4-layers

## Notes

- 1) The information contained herein is subject to change without notice.
- 2) Before you use our Products, please contact our sales representative and verify the latest specifications :
- 3) Although ROHM is continuously working to improve product reliability and quality, semiconductors can break down and malfunction due to various factors.  
Therefore, in order to prevent personal injury or fire arising from failure, please take safety measures such as complying with the derating characteristics, implementing redundant and fire prevention designs, and utilizing backups and fail-safe procedures. ROHM shall have no responsibility for any damages arising out of the use of our Products beyond the rating specified by ROHM.
- 4) Examples of application circuits, circuit constants and any other information contained herein are provided only to illustrate the standard usage and operations of the Products. The peripheral conditions must be taken into account when designing circuits for mass production.
- 5) The technical information specified herein is intended only to show the typical functions of and examples of application circuits for the Products. ROHM does not grant you, explicitly or implicitly, any license to use or exercise intellectual property or other rights held by ROHM or any other parties. ROHM shall have no responsibility whatsoever for any dispute arising out of the use of such technical information.
- 6) The Products specified in this document are not designed to be radiation tolerant.
- 7) For use of our Products in applications requiring a high degree of reliability (as exemplified below), please contact and consult with a ROHM representative : transportation equipment (i.e. cars, ships, trains), primary communication equipment, traffic lights, fire/crime prevention, safety equipment, medical systems, servers, solar cells, and power transmission systems.
- 8) Do not use our Products in applications requiring extremely high reliability, such as aerospace equipment, nuclear power control systems, and submarine repeaters.
- 9) ROHM shall have no responsibility for any damages or injury arising from non-compliance with the recommended usage conditions and specifications contained herein.
- 10) ROHM has used reasonable care to ensure the accuracy of the information contained in this document. However, ROHM does not warrants that such information is error-free, and ROHM shall have no responsibility for any damages arising from any inaccuracy or misprint of such information.
- 11) Please use the Products in accordance with any applicable environmental laws and regulations, such as the RoHS Directive. For more details, including RoHS compatibility, please contact a ROHM sales office. ROHM shall have no responsibility for any damages or losses resulting non-compliance with any applicable laws or regulations.
- 12) When providing our Products and technologies contained in this document to other countries, you must abide by the procedures and provisions stipulated in all applicable export laws and regulations, including without limitation the US Export Administration Regulations and the Foreign Exchange and Foreign Trade Act.
- 13) This document, in part or in whole, may not be reprinted or reproduced without prior consent of ROHM.



Thank you for your accessing to ROHM product informations.  
More detail product informations and catalogs are available, please contact us.

## ROHM Customer Support System

<http://www.rohm.com/contact/>