

Linear Regulator Series

BDxxGA3 Series Application Information

The information in this application note only provides hints for IC mounting. For this reason, these notes should not be considered as an IC quality explanation or a warranty. See the latest data sheet for the IC standard values. Also, note that the application circuits used in the explanations for each item have been simplified. Be sure to verify operations using the actual application.

Table of contents

1. Typical Application Circuit.....	2
1.1. Adjustable output type BD00GA3WEFJ, BD00GA3MEFJ-LB, BD00GA3MEFJ-M, BD00GA3WNUX	2
1.2. Fixed output type BDxxGA3WEFJ, BDxxGA3MEFJ-LB, BDxxGA3MEFJ-M, BDxxGA3WNUX	3
2. Output voltage setting (Adjustable output type)	4
3. Kelvin connection	5
4. Output voltage tolerance	5
5. Study of input/output voltage difference and characteristics	6
6. Output control (EN) pin	6
7. Output capacitor	7
8. Input capacitor	8
9. Load	8
10. Efficiency	9
11. Thermal design.....	10
12. Terminal protection	13
13. Soft start.....	16
14. Sequence for turning power on	17
15. Sequence for turning power off	21
16. Inrush current.....	24
17. Over current protection (OCP).....	25
18. Thermal shutdown (TSD)	25
19. Input-output equivalent circuit	26
20. Lineup	27

1. Typical Application Circuit

1.1. Adjustable output type BD00GA3WEFJ, BD00GA3MEFJ-LB, BD00GA3MEFJ-M, BD00GA3WNUX

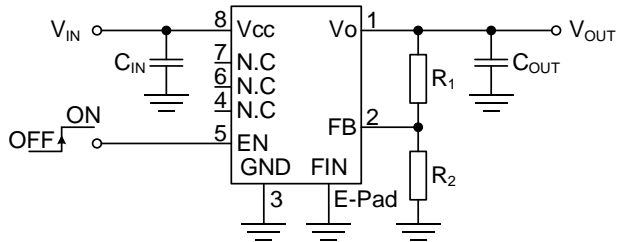

Figure 1-1. When using the output ON/OFF function

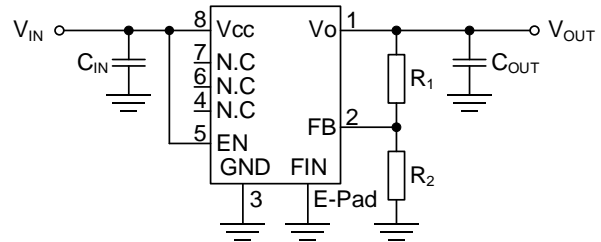

Figure 1-2. When not using the output ON/OFF function

Type	BD00GA3WEFJ BD00GA3MEFJ-LB BD00GA3MEFJ-M	BD00GA3WNUX
Package	HTSOP-J8	VSON008X2030
Pin configuration (Top View)		

Pin number	Pin name	Function
1	Vo	Output pin Supplies electrical power to the load. To prevent vibrations on this pin, connect Vo and GND with a capacitor. → See page 7.
2	FB	Output voltage setting pin The FB pin is a tolerance amp input pin. Based on the ground, the FB pin voltage can be outputted from 1.5 V to 13 V at 0.8 V. Connect a resistor divider circuit. → See page 4.
3	GND	Ground This is the ground for the regulator circuit.
4	N.C	Unconnected pin This is not connected to the internal circuit. Leave this open or connect GND.
5	EN	Enable pin The IC can be set to shutdown status by using the EN pin. Set to the pin to “High” to turn output on, and to “Low” to turn output off. → See page 6.
6, 7	N.C	Unconnected pin This is not connected to the internal circuit. Leave this open or connect GND.
8	Vcc	Input pin Power is supplied to the IC through the input pin. To stabilize the pin input, connect Vcc and GND with a ceramic capacitor. Place the capacitor near the pin. → See page 8.
E-Pad	FIN	Exposed pad The exposed pad is connected to the die via the lead frame. We recommend soldering exposed pad to a ground plane with a wide copper foil area to improve heat dispersion efficiency. Also, exposed pad is electrically connected to GND in the package internally via substrate.

1. Typical Application Circuit

1.2. Fixed output type BDxxGA3WEFJ, BDxxGA3MEFJ-LB, BDxxGA3MEFJ-M, BDxxGA3WNUX

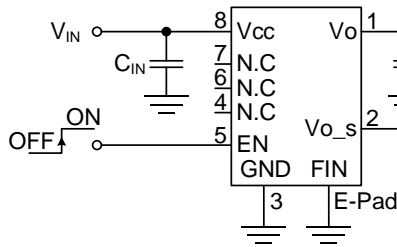

Figure 1-3. When using the output ON/OFF function

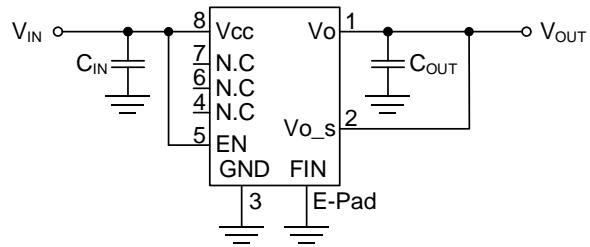

Figure 1-4. When not using the output ON/OFF function

Type	BDxxGA3WEFJ BDxxGA3MEFJ-LB BDxxGA3MEFJ-M	BDxxGA3WNUX
Package	HTSOP-J8	VSON008X2030
Pin configuration (Top View)		

Pin number	Pin name	Function
1	Vo	Output pin Supplies electrical power to the load. To prevent vibrations on this pin, connect Vo and GND with a capacitor. → See page 7.
2	Vo_s	Output voltage monitor pin This pin is used to eliminate drops in voltage that occur due to wiring resistance between the regulator output and the load. → See page 5.
3	GND	Ground This is the ground for the regulator circuit.
4	N.C	Unconnected pin This is not connected to the internal circuit. Leave this open or connect GND.
5	EN	Enable pin The IC can be set to shutdown status by using the EN pin. Set to the pin to “High” to turn output on, and to “Low” to turn output off. → See page 6.
6, 7	N.C	Unconnected pin This is not connected to the internal circuit. Leave this open or connect GND.
8	Vcc	Input pin Power is supplied to the IC through the input pin. To stabilize the pin input, connect Vcc and GND with a ceramic capacitor. Place the capacitor near the pin. → See page 8.
E-Pad	FIN	Exposed pad The exposed pad is connected to the die via the lead frame. We recommend soldering exposed pad to a ground plane with a wide copper foil area to improve heat dispersion efficiency. Also, exposed pad is electrically connected to GND in the package internally via substrate.

2. Output voltage setting (Adjustable output type)

Adjustable output voltage types use an external resistor divider, allowing the output voltage to be set from 1.5 V to 13 V. The output voltage can be calculated with the following equation.

$$V_{OUT} = 0.8 \times \frac{R_1 + R_2}{R_2} \quad [V] \quad (2-1)$$

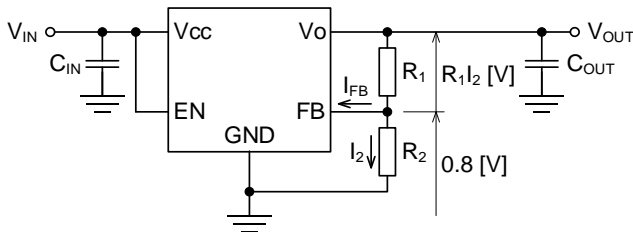

Figure 2-1. Output voltage setting

The FB pin of this IC outputs at 0.8 V, based on the ground. The I_2 current of R_2 can be calculated at $0.8 \text{ V}/R_2$, and the current of R_1 is the current of R_2 with the addition of the bias current I_{FB} . Note that as the internal circuit of the FB pin is a gate input, the bias current (10 nA) is slight and can be ignored. The voltage of R_1 multiplied by I_2 added to 0.8 V is the output voltage V_{OUT} , as shown in the following equation.

$$V_{OUT} = 0.8 + R_1 I_2 = 0.8 + R_1 \frac{0.8}{R_2} = 0.8 \times \left(1 + \frac{R_1}{R_2} \right)$$

To obtain the optimum load regulation performance, directly connect the PCB traces to the bottom side of the output voltage setting resistor.

The setting resistance for a typical output voltage is shown next. In this example. The E24 series is used for the nominal resistance values. Use the same type of resistors for R_1 and R_2 . If different types are used, the ratio for R_1 and R_2 will change due to the differences in their tolerances and temperature characteristics, which may degrade the output voltage precision. When using chip resistances at or below a size of 0402 mm (01005 inch), select the parts while using caution for the rated power of the resistor and the maximum voltage.

Setting with minimum number of components

Target V_O (V)	R_1 (kΩ)	R_2 (kΩ)	Calc. V_O (V)	Error (%)
1.5	13	15	1.493	- 0.444
1.8	15	12	1.800	0
1.85	12	9.1	1.855	+ 0.267
1.9	22	16	1.900	0
2	15	10	2.000	0
2.05	47	30	2.053	+ 0.163
2.1	9.1	5.6	2.100	0
2.2	16	9.1	2.207	+ 0.3
2.3	30	16	2.300	0
2.5	51	24	2.500	0
2.55	18	8.2	2.556	+ 0.239
2.6	27	12	2.600	0
2.7	43	18	2.711	+ 0.412
2.75	39	16	2.750	0
2.8	30	12	2.800	0
2.85	10	3.9	2.851	+ 0.045
2.9	24	9.1	2.910	+ 0.341
2.95	43	16	2.950	0
3	33	12	3.000	0
3.1	43	15	3.093	- 0.215
3.2	30	10	3.200	0
3.3	7.5	2.4	3.300	0
3.4	39	12	3.400	0
3.5	9.1	2.7	3.496	- 0.106
3.7	33	9.1	3.701	+ 0.03
5	43	8.2	4.995	- 0.098
5.4	27	4.7	5.396	- 0.079
6	13	2	6.000	0
6.3	11	1.6	6.300	0
7	30	3.9	6.954	- 0.659
8	27	3	8.000	0
9	47	4.7	8.800	- 2.222
10	15	1.3	10.031	+ 0.308
12	51	3.6	12.133	+ 1.111
13	20	1.3	13.108	+ 0.828

High precision setting

Target V_O (V)	R_1 (kΩ)	R_2 (kΩ)	Calc. V_O (V)	Error (%)
1.5	6.2+4.3	12	1.500	0
1.8	15	12	1.800	0
1.85	15+0.75	12	1.850	0
1.9	22	16	1.900	0
2	15	10	2.000	0
2.05	18+0.75	12	2.050	0
2.1	9.1	5.6	2.100	0
2.2	10+7.5	10	2.200	0
2.3	30	16	2.300	0
2.5	51	24	2.500	0
2.55	20+15	16	2.550	0
2.6	27	12	2.600	0
2.7	22+16	16	2.700	0
2.75	39	16	2.750	0
2.8	30	12	2.800	0
2.85	30+0.75	12	2.850	0
2.9	30+1.5	12	2.900	0
2.95	43	16	2.950	0
3	33	12	3.000	0
3.1	30+16	16	3.100	0
3.2	30	10	3.200	0
3.3	7.5	2.4	3.300	0
3.4	39	12	3.400	0
3.5	33+0.75	10	3.500	0
3.7	36+7.5	12	3.700	0
5	51+12	12	5.000	0
5.4	56+1.5	10	5.400	0
6	47+18	10	6.000	0
6.3	68+0.75	10	6.300	0
7	24+3.9	3.6	7.000	0
8	27	3	8.000	0
9	33+3.9	3.6	9.000	0
10	68+3.3	6.2	10.000	0
12	51+3.6	3.9	12.000	0
13	51+3.9	3.6	13.000	0

3. Kelvin connection

Normally, the optimum regulation can be achieved at the time that the output voltage setting resistor is connected to the Vo pin. For applications where the load current is frequent, the wiring width is narrow, the distance to the load is great and so on, the voltage may drop due to resistance in the PCB traces, which may result in a lower voltage at the load point. You can eliminate this influence by bringing the upper side of the output voltage setting resistance divider as close to the load as possible to connect. Place resistance voltage dividers with high impedance close to the IC and stretch out the traces on the upper side of the resistor with low impedance, to achieve noise tolerance. Connect the GND side of the IC as well using an independent ground trace to the load, so that it is not influenced by voltage drops in load current. As the IC's output capacitor C_{OUT} is used to prevent oscillation, place it close to the IC; and place a large capacitance capacitor C_{BULK} close to the load to respond to abrupt loads (Figure 3-1).

For the fixed output type, output voltage setting resistors are built in, so the upper side of the resistor divider is often connected to the output inside of the IC. In this configuration, the voltage may drop due to the wiring resistance up to the load. On this regulator

IC, the upper side of the resistor divider goes to the Vo_s pin, so that a Kelvin connection can be made as with the adjustable output type (Figure 3-2).

4. Output voltage tolerance

The maximum output voltage tolerance for a fixed output type is the sum of the output voltage tolerance, the input constancy tolerance and the load constancy tolerance. For an adjustable output type, the maximum output voltage tolerance is the sum of the reference-voltage (C terminal voltage V_C) tolerance times the tolerance external resistor for output voltage settings (see the following formula), the input constancy tolerance and the load constancy tolerance.

Output voltage tolerance for adjustable output type

Minimum value

$$V_{OUT(MIN)} = V_{C(MIN)} \times \frac{R_{1(MIN)} + R_{2(MAX)}}{R_{2(MAX)}} [V] \quad (4-1)$$

Maximum value

$$V_{OUT(MAX)} = V_{C(MAX)} \times \frac{R_{1(MAX)} + R_{2(MIN)}}{R_{2(MIN)}} [V] \quad (4-2)$$

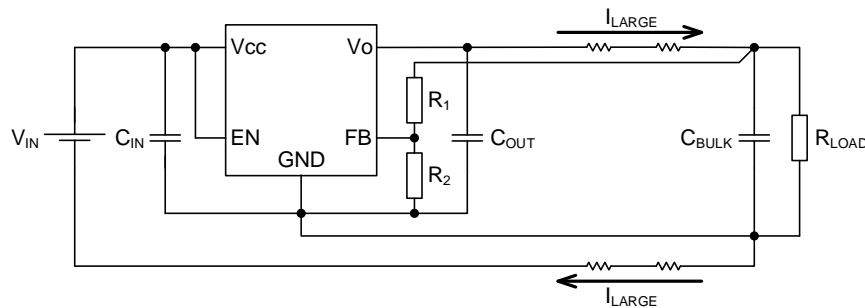

Figure 3-1. Kelvin connection (Adjustable output type)

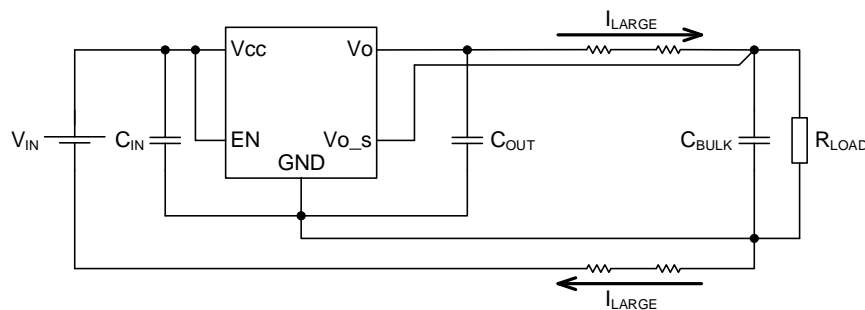

Figure 3-2. Kelvin connection (Fixed output type)

5. Study of input/output voltage difference and characteristics

For the minimum value of the input voltage, the minimum input/output voltage at the load current to be used is read from the “Input/output voltage difference vs. output current” graph on the data sheet, to get the voltage added to the output voltage. As this time, this works as DC, but the control capacity is degraded. When there are fluctuations in the load, a large current cannot be supplied in a short period of time from input to output, as the input/output voltage difference is small. In other words, the load responsiveness will slow down. The slowness in responsiveness will also show up as a degradation in PSRR characteristics. If only the minimum voltage amount of the input/output voltage difference is ensured because efficiency is emphasized, the expected characteristics of the LDO will not be achieved. Increase the input voltage until the high-speed load responsiveness and PSRR capabilities are achieved, and find a compromise between efficiency and each characteristic.

6. Output control (EN) pin

The output can be turned on/off by using the CTL pin. When EN is at a low level, V_o will turn off; and as the operations of the entire IC will be turned off, the current consumption will be zero. When EN is at the high level, the IC turns on, and V_o turns on. To make certain that IC is turned on/off, apply the voltage that is listed in the electrical characteristics on the data sheet for the EN pin voltage. For the designed reference values, the threshold median value is approximately 1.7 V, the tolerance is around ± 0.2 V, the temperature characteristic is around 1.85 V to 1.5 V (-40°C to $+105^\circ\text{C}$), and overall is around 1.3 V to 2.05 V.

The EN pin is an output voltage on/off control pin and operates as a switch, but is designed based on the assumption that switching between High/Low on the normal EN input will be over a short time. Stabilize the EN pin at the midpoint potential of the High/Low switch. At the intermediate potential, the output voltage may become unstable.

There are no restrictions on the start sequence for V_{cc} and EN.

When not using the output control function, connect the EN pin to V_{cc} . At this time, a series resistor is unnecessary.

The delay time between when the EN pin reaches “High” and the output voltage starts is approximately 200 μs (design reference value; Figure 6-1).

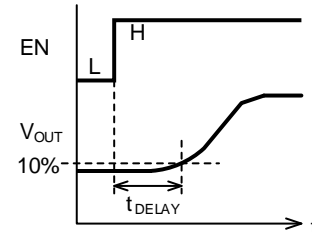

Figure 6-1. Definition of startup delay time

Controlling the EN pin via mechanical switch may cause chattering in the output voltage, due to chattering in the switch. Insert an RC filter before the EN pin, and make sure that the chattering waveform does not reach the EN pin (upper part of Figure 6-2). If the wiring between the EN pin and switch is long, a large pulse wave may be generated due to the inductance component of the wiring; and if this voltage exceeds the voltage capacity of the EN pin, the IC may break down. It is necessary to insert an RC filter before the EN pin, in order to lower the peak value of the pulse waveform (lower part of Figure 6-2). Change the C value to adjust the waveform.

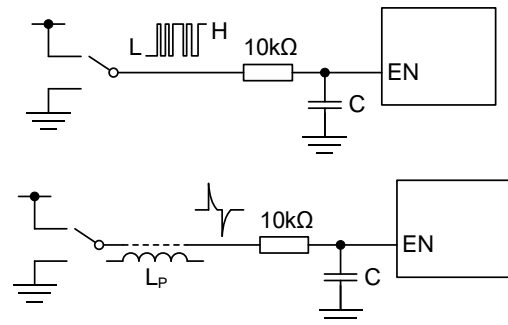

Figure 6-2. RC filter circuit for EN pin

7. Output capacitor

Place the output capacitor within 3 cm of the Vo-GND pin IC, in order to stabilize the loop. Connect a capacitor with an actual capacitance of 1 μF or greater, considering the tolerance and temperature characteristics. If the capacitance is too small, oscillation may occur. Although there is no limit to the maximum value for the output capacitance, the following points must be considered. Increasing the capacitance will lengthen the charging time when the power is on, and the discharging time when the power is off. Since it is possible that the IC can be damaged when turning off the power due to an input and output voltage inversion, which causes a large current to flow back into the IC, connect a reverse current bypass diode or a reverse current protection diode.

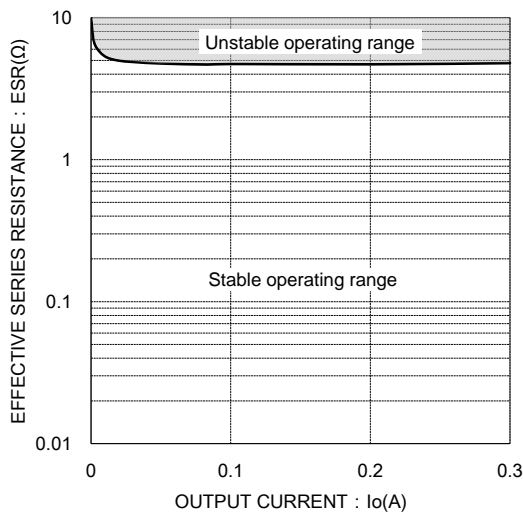

Figure 7-1. ESR stable operating range

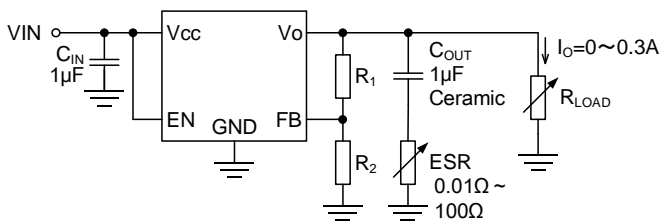

Figure 7-2. ESR stable operating range evaluation circuit

Refer to Figure 7-1 for the ESR. This graph is based on an evaluation circuit for Figure 7-2, and is not perfectly equal to the capacitor that is actually used. Also, as this is based on the IC

alone and the resistive load, it will change in reality due to the wiring impedance and input power impedance on the board. For this reason, check sufficiently whether there are oscillations by using the conditions of the final product.

When using a ceramic capacitor, we recommend the use of an X5R or X7R, which have good temperature characteristics. Do not use Z5U, Y5V or F, which have large capacitance variances (Figure 7-3). Although the capacitance value will fall below the nominal value due to differences in tolerance, temperature characteristics and DC bias characteristics, set it so that the capacitance does not fall below the minimum value (1 μF). For the DC bias characteristics, the capacitance tends to drop more with smaller sizes (Figure 7-4).

STD	Char	Temperature Characteristic	
		TEMP Range	Capacity Change Rate
JIS	B	-25 to +85 °C	±10%
EIA	X5R	-55 to +85 °C	±15%
EIA	X7R	-55 to +125 °C	±15%
EIA	X7U	-55 to +125 °C	+22%, -56%
JIS	F	-25 to +85 °C	+30%, -80%
EIA	Y5V	-30 to +85 °C	+22%, -82%
EIA	Z5U	+10 to +85 °C	+22%, -56%
EIA	Z5V		+22%, -82%

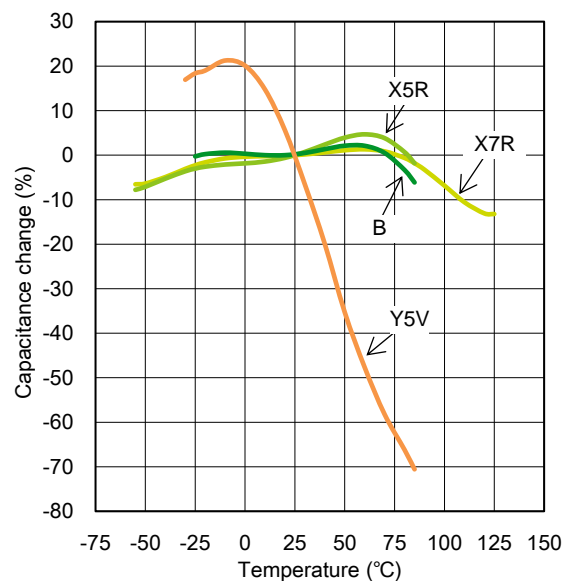

Figure 7-3. Temperature characteristic of major high dielectric constant multilayer ceramic capacitor

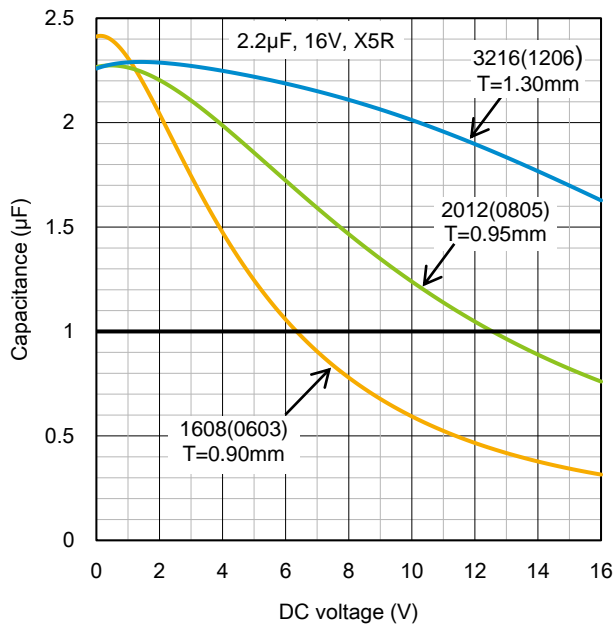

Figure 7-4. DC bias characteristic of high dielectric constant multilayer ceramic capacitor, comparison by size

Although electrolytic capacitors are inexpensive and offer a large capacitance, caution must be used, as the electrolyte may harden at low temperatures, leading to a sudden drop in capacitance and an increase in ESR. Also, if the heat from the LDO reaches the electrolytic capacitor, the electrolyte will become hot, which has an impact on the lifespan of the capacitor. To resolve this, place the electrolytic capacitor further away so that it does not get too hot, or reduce the width of the copper wiring to the minimum current capacity tolerance, so that heat is not easily transmitted from the LDO.

If the fluctuations in the load current are abrupt, ripple voltage may occur in output. To reduce the ripple voltage, increase the capacitance of the output capacitor. Since ceramic capacitors with a large capacitance are expensive, you can reduce costs by adding an aluminum electrolytic capacitor, using small-capacitance ceramic capacitors in parallel as a bulk capacitor. Increasing the output capacitance will increase the electrical charge that charges the output capacitor from the input side. For this reason, a voltage drop may occur if the load responsiveness of the input side power is not good. To prevent this, use a larger input capacitor that is appropriate for the output capacitance.

8. Input capacitor

The purpose of the input capacitor is to keep down the phase fluctuations in the power line during circuit operations, stabilizing the IC input. When the input trace is particularly long or when the input power impedance is high, the input capacitor is effective in ensuring the stability of the LDO input power. Connect the capacitor within 1 cm of the Vcc-GND pin IC. The purpose of the input capacitor is to make the source impedance smaller. For this reason, we recommend a ceramic capacitor with a small ESR. Connect a capacitor with an actual capacitance of 1 µF or greater. Although the capacitance value will fall below the nominal value due to differences in tolerance, temperature characteristics and DC bias characteristics, set it so that the capacitance does not fall below the minimum value (1 µF). If the output current changes drastically, increasing the capacitance of the output capacitor will reduce the ripple voltage. However, if there are momentary problems with the current supply potential on the input current side due to the larger output capacitor, the input voltage may drop. To prevent this, increase the capacitance of the input capacitor as well, so that it approximates the input capacitance. For the bulk capacitor, connect an aluminum electrolytic capacitor in parallel with the ceramic capacitor.

9. Load

As this IC has over current protection (OCP) characteristics resembling the number “7”, when the load is a constant current source or when the output voltage is negative when starting up, the output voltage will not rise if the load current exceeds the IC output (supply) current, and the IC will fail to start up.

The IC will operate when the constant current load is on after the IC’s output voltage is at the default value on startup; but afterwards, if the thermal shutdown circuit operates and the output goes off, the IC cannot be restarted. Further, if the IC cannot be started, constant current load will flow to the electrostatic breakdown protection diode (between Vo-GND). Due to this, the chip temperature will rise depending on the current value, which may result in destruction of the IC or solder melting. For this reason, use of constant current load is not recommended.

10. Efficiency

The efficiency can be calculated with the following equation.

$$\eta = \frac{P_{OUT}}{P_{IN}} = \frac{V_{OUT} \times I_{OUT}}{V_{CC} \times (I_{OUT} + I_{CC})} \times 100 \quad [\%] \quad (10-1)$$

V_{CC} : Input voltage [V]

V_{OUT} : Output voltage [V]

I_{OUT} : Output current [A]

I_{CC} : IC circuit current [A]

Note that when $I_{CC} \ll I_{OUT}$, efficiency can be calculated with the following equation.

$$\eta = \frac{V_{OUT}}{V_{CC}} \times 100 \quad [\%] \quad (10-2)$$

We can see from the equation that smaller voltage differences between inputs/outputs result in better efficiency.

11. Thermal design

To ensure highly reliable operations, it is necessary to make sure that the IC junction temperature does not exceed 150°C. The junction temperature estimate can be calculated using the following two methods.

1. When measuring the IC temperature using the surface temperature, use thermal characteristic parameter ψ_{JT} for the calculation. If the thermocouple can be firmly stabilized at the package surface center, the temperature T_T at the package surface center can be precisely measured. Because of this, the junction temperature can be calculated precisely by using this thermal characteristic parameter.

$$T_J = T_T + \psi_{JT} \times P \quad [^\circ\text{C}] \quad (11-1)$$

T_T : Temperature at the center of the package surface [°C]
 ψ_{JT} : Thermal characteristics parameter from junction to center of package surface [°C/W]
 P : IC consumption power [W]

P can be calculated by the IC consumption power using the following equation.

$$P = (V_{CC} - V_{OUT}) \times I_{OUT} + (V_{CC} \times I_{CC}) \quad [W] \quad (11-2)$$

V_{CC} : Input voltage [V]
 V_{OUT} : Output voltage [V]
 I_{OUT} : Output current [A]
 I_{CC} : IC circuit current [A]

Also, the peak output current that can flow constantly can be calculated with the following equation.

$$I_{OUT(MAX)} = \frac{T_{J(MAX)} - T_T}{(V_{CC} - V_{OUT}) \times \psi_{JT}} \quad [A] \quad (11-3)$$

$T_{J(MAX)}$: Absolute maximum rating for junction temperature [°C]
 T_T : Temperature at the center of the package surface [°C]
 ψ_{JT} : Thermal characteristics parameter from junction to center of package surface [°C/W]
 V_{CC} : Input voltage [V]
 V_{OUT} : Output voltage [V]

2. Use thermal resistance θ_{JA} to easily calculate the junction temperature.

$$T_J = T_A + \theta_{JA} \times P \quad [^\circ\text{C}] \quad (11-4)$$

T_A : Ambient temperature [°C]
 θ_{JA} : Thermal resistance between junction and ambient temperature [°C/W]
 P : IC consumption power [W]

Also, the peak output current that can flow constantly can be calculated with the following equation.

$$I_{OUT(MAX)} = \frac{T_{J(MAX)} - T_A}{(V_{CC} - V_{OUT}) \times \theta_{JA}} \quad [A] \quad (11-5)$$

$T_{J(MAX)}$: Absolute maximum rating for junction temperature [°C]
 T_A : Ambient temperature [°C]
 θ_{JA} : Thermal resistance between junction and ambient temperature [°C/W]
 V_{CC} : Input voltage [V]
 V_{OUT} : Output voltage [V]

The thermal characteristics parameter ψ_{JT} and thermal resistance θ_{JA} are values measured using a specific PCB. As the influence of PCB characteristics, copper foil layout, parts layout, chassis shape, surrounding environment and so on cause heat radiation to change, the thermal characteristics parameter and thermal resistance will also change. It is necessary to consider that the values will differ from the actual equipment board.

HTSOP-J8 package thermal characteristics parameters and thermal resistance

PCB type	ψ_{JT} (°C/W)	θ_{JA} (°C/W)
1 layer (1s)	15	130.4
2 layers (2s)	6	38.7
4 layers (2s2p)	5	29.2

Figure 11-1 through 11-13 and Table 11-1 to 11-3 shows the specifications for the PCB used in measurement.

HTSOP-J8 package PCB specifications, 1 layer (1s)
 Conforms to JEDEC standard JESD51-3/ -7

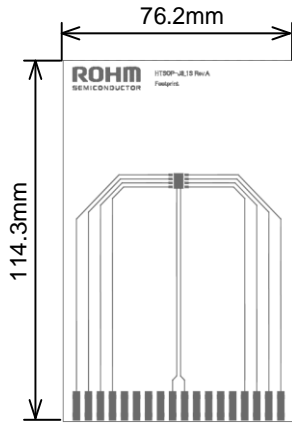

Figure 11-1. Top Layer Trace

HTSOP-J8 package PCB specifications, 2 layers (2s)
 Conforms to JEDEC standard JESD51-3/ -5/ -7

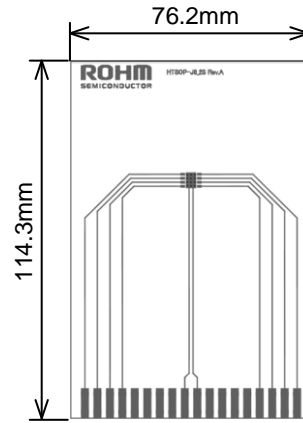

Figure 11-4.
 Top Layer Trace

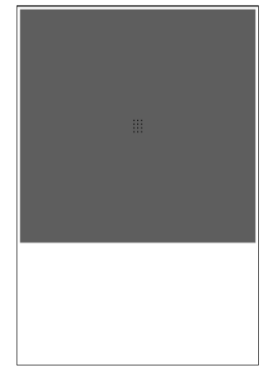

Figure 11-5.
 Bottom Layer Trace

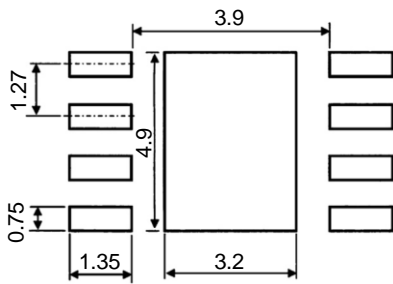

Figure 11-2. Footprint



Figure 11-3. 1-layer board sectional view

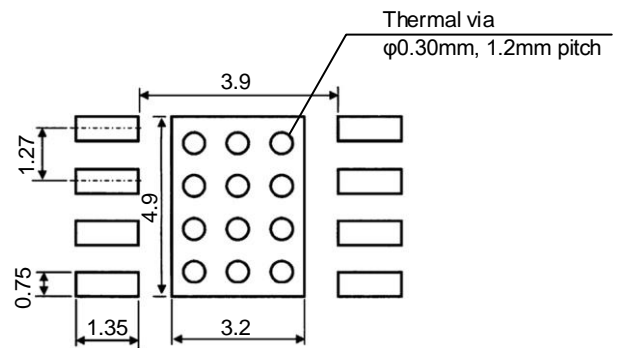

Figure 11-6. Footprint

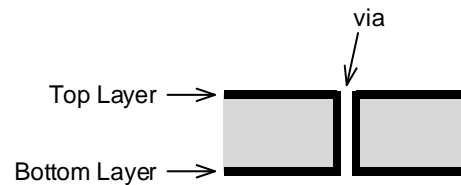

Figure 11-7. 2-layer board sectional view

Item	Value
Board thickness	1.57 mm
Board outline dimensions	76.2 mm x 114.3 mm
Board material	FR-4
Trace thickness (Finish thickness)	70 μm (2 oz)
Lead width	0.254 mm
Copper foil area	Footprint

Table 11-1. 1-layer PCB specifications

Item	Value
Board thickness	1.60 mm
Board outline dimensions	76.2 mm x 114.3 mm
Board material	FR-4
Trace thickness (Finish thickness)	Top 70 μm (2 oz) Bottom 70 μm (2 oz)
Lead width	0.254 mm
Copper foil area	Top Footprint Bottom 5505 mm ² (74.2 mm x 74.2 mm)

Table 11-2. 2-layer PCB specifications

HTSOP-J8 package PCB specifications, 4 layers (2s2p)

Conforms to JEDEC standard JESD51-3/ -5/ -7

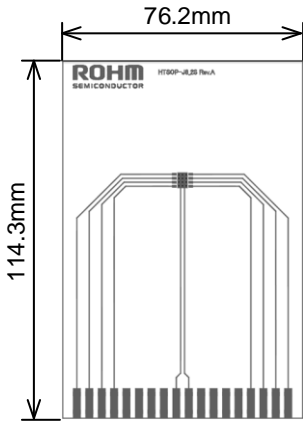

Figure 11-8.
Top Layer Trace

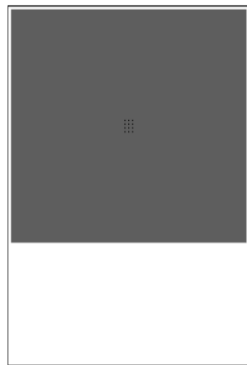

Figure 11-9.
Middle 1 Layer Trace

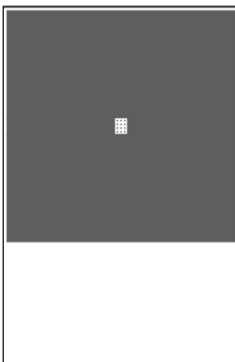

Figure 11-10.
Middle 2 Layer Trace

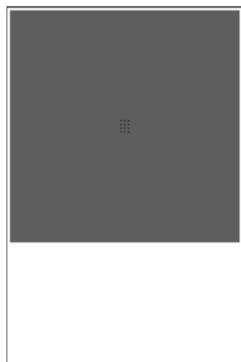

Figure 11-11.
Bottom Layer Trace

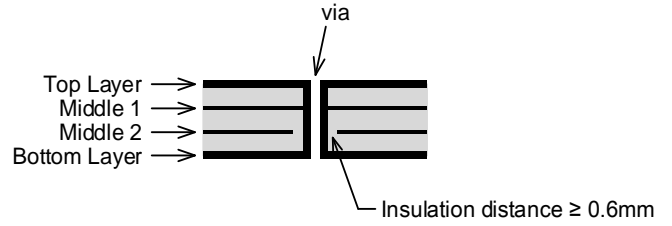

Figure 11-13. 4-layer board sectional view

Item		Value
Board thickness		1.60 mm
Board outline dimensions		76.2 mm x 114.3 mm
Board material		FR-4
Trace thickness (Finish thickness)	Top	70 μm (2 oz)
	Middle 1	35 μm (1 oz)
	Middle 2	35 μm (1 oz)
	Bottom	70 μm (2 oz)
Lead width		0.254 mm
Copper foil area	Top	Footprint
	Middle 1	5505 mm ² (74.2 mm x 74.2 mm)
	Middle 2	5505 mm ² (74.2 mm x 74.2 mm)
	Bottom	5505 mm ² (74.2 mm x 74.2 mm)

Table 11-3. 4-layer PCB specifications

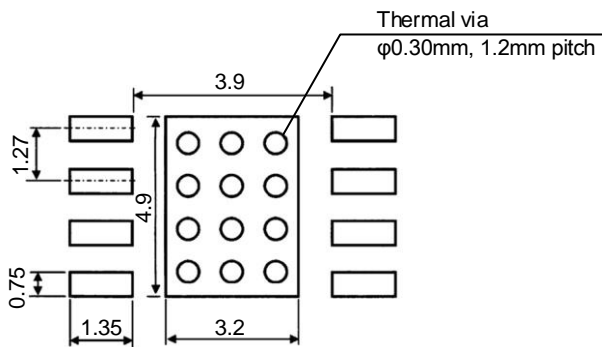

Figure 11-12. Footprint

12. Terminal protection

If inverse or excess voltage is applied to the IC terminals, the device may be damaged or the output voltage may not rise. When the following conditions are anticipated, we recommend that the terminals be adequately protected.

1. When the input/output voltage conditions are reversed
→ Reverse current bypass
2. When the output load is conductive
→ Output reverse voltage protection
3. Possibility of input polarities connected in reverse
→ Input reverse voltage protection
4. Hot-plugging → Hot-plugging countermeasures
5. Load exists between disparate power sources
→ Reverse current bypass
6. Positive-negative power source (both power sources)

1. When the input/output voltage conditions are reversed

When the capacitance of the output capacitor is large, and a load remains in the output capacitor even after the input power shuts down, or the speed that the input power shuts down is extremely fast, reverse current will flow from output to input via parasitic elements in the IC because the input/output voltage state will be inverted. Operation is not guaranteed for parasitic elements, and this can degrade or destroy elements.

As a countermeasure, connect a reverse current bypass diode externally (Figure 12-1), so that the reverse current does not pass through the inside of the IC. Note that when the input side is left open and the IC is powered down, no degradation of parasitic elements or breakdown will occur due to the reverse current value being a slight IC bias current only. Owing to this, the bypass diode is not necessary (Figure 12-2).

It is necessary for the bypass diode to turn on before the parasitic element in the IC. As the voltage to turn on the internal parasitic element is approximately 0.6 V for the MOSFET type regulator, a low forward voltage of V_F is required. When the value of the reverse current is large, a considerable amount of diode leakage current will flow from input to output, even if the output is off during shutdown. For this reason, a small value (around 1 μA or less) must be selected. Select an inverse rated

voltage that is larger than the input/output voltage difference (80% derating or less) to be used. Select a forward direction rated current that is larger than the reverse rated current value (50% derating or less) to be used. From the above conditions, we recommend a rectifier diode or Schottky barrier diode; but as the inverse current of many Schottky barrier diodes is generally large, select one with a small value.

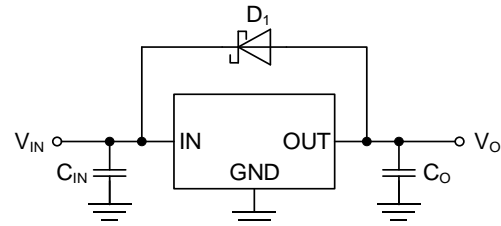

Figure 12-1. Reverse current bypass diode

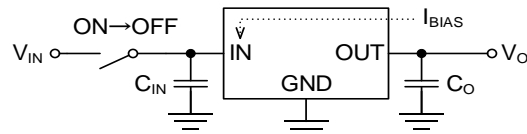

Figure 12-2. When the input is open

2. When the output load is conductive

When the output load is conductive, the energy stored in the conductive load at the instant the output voltage goes off will be shunted to ground. A diode is used between the IC output pin and GND pin to prevent electrostatic breakdown. If a large electric current flows to this diode, the IC may break down. To prevent this, connect a Schottky barrier diode in parallel to the electrostatic breakdown prevention diode (Figure 12-3).

When the IC output pin and load are connected via a long wire, a conductive load may occur. Measure the waveform using an oscilloscope. Aside from this, when the load is a motor, a diode is necessary due to counter electromotive force in the motor, which causes the same kind of current to flow.

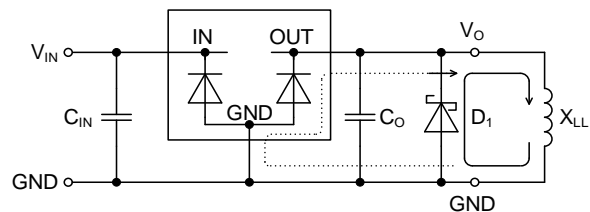

Figure 12-3. Conductive load current path (when output is off)

3. Possibility of input polarities connected in reverse

When connecting an input to power, if the positive and negative terminals are connected in reverse due to careless error, a large electric current may flow between the IC input pin and the GND pin to the electrostatic breakdown prevention diode (Figure 12-4). The easiest countermeasure is to connect a Schottky barrier diode or a rectifier diode in series with the power, as shown in Figure 12-5. Using the correct connection, a power loss will occur in $V_F \times I_O$ due to a voltage drop in the forward voltage V_F of the diode, so this is not suitable for a battery-operated circuit. The V_F for a Schottky barrier diode is lower than that of a rectifier diode, so the loss will be somewhat smaller. Since the diode will get hot, select a diode with a wide margin of power dissipation. When connected in reverse, current for the diode will flow in reverse, but the value will be slight.

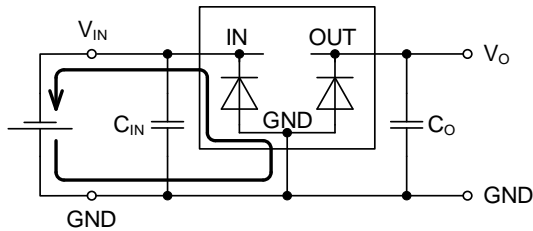

Figure 12-4. Current path when the input is connected in reverse

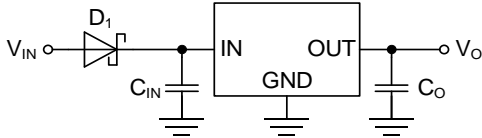

Figure 12-5. Countermeasure #1 against reverse connection

Figure 12-6 shows how to connect the diode in parallel with the power source. Since it is necessary for the diode to turn on faster than the electrostatic breakdown protection diode inside the IC, use a Schottky barrier diode with a low V_F . Using the correct connection, this will operate in the same way as without the diode. Since the total current will keep flowing to the diode when connected in reverse, heat will occur, which may lead to breakdown if the current capacity in the previous stage is too large. The prerequisites for this circuit are either to protect the circuit from accidental mistakes over the short-term, or for an over current protection circuit to be present in the previous stage.

For placing greater emphasis on safety by using a protection circuit, connect the power source in series to the fuse. Although maintenance of the fuse is required, this will protect the circuit with even greater certainty (Figure 12-7).

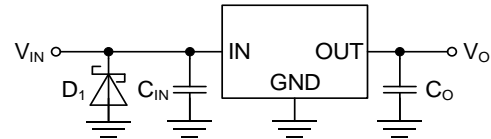

Figure 12-6. Countermeasure #2 against reverse connection

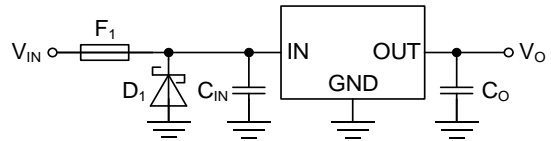

Figure 12-7. Countermeasure #3 against reverse connection

Figure 12-8 shows how to connect the P-ch MOSFET in series with the power source. The diode between the MOSFET drain-source is a body diode (parasitic element). Using the correct connection, the P-ch MOSFET will be on, and the voltage drop here will be the ON resistance of MOSFET times the output current I_O . As this is smaller than the voltage drop via diode (Figure 12-5), the power loss will be smaller. When connecting in reverse, MOSFET will not turn on, so there will be no current flow.

When this value exceeds the rated voltage between MOSFET gate-source (in consideration of derating), divide the resistance between gate and source, and lower the gate-source voltage as shown in Figure 12-9.

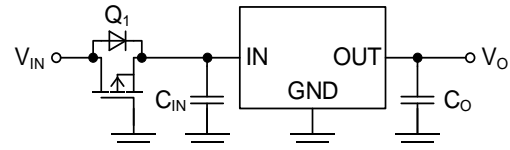

Figure 12-8. Countermeasure #4 against reverse connection

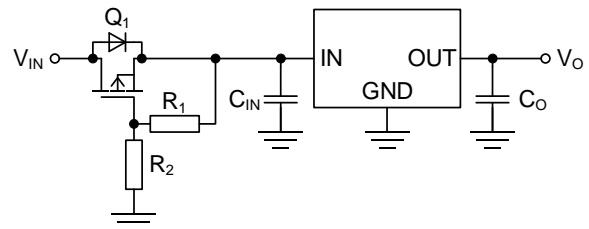

Figure 12-9. Countermeasure #5 against reverse connection

4. Hot-plugging

When connecting a wire to the IC input while the supply side power is on, a pulse waveform will be generated due to contact between the wiring inductance component and the metal of the connector plug. If this surge voltage exceeds the IC's absolute maximum rating, the IC may break down. Use a TVS (transient voltage suppressor) diode to absorb the surge, so that the surge voltage does not reach the IC input pin (Figure 12-10).

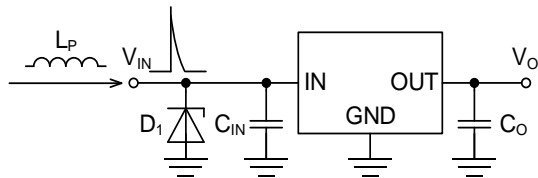

Figure 12-10. Hot-plugging countermeasure

5. Load exists between disparate power sources

As shown in Figure 12-11, when a load exists between disparate power sources, the timing for rises and drops are different, so current will flow to another power output terminal through the load. Reverse voltage will occur between IC inputs and outputs at this time, so a reverse current bypass diode is needed.

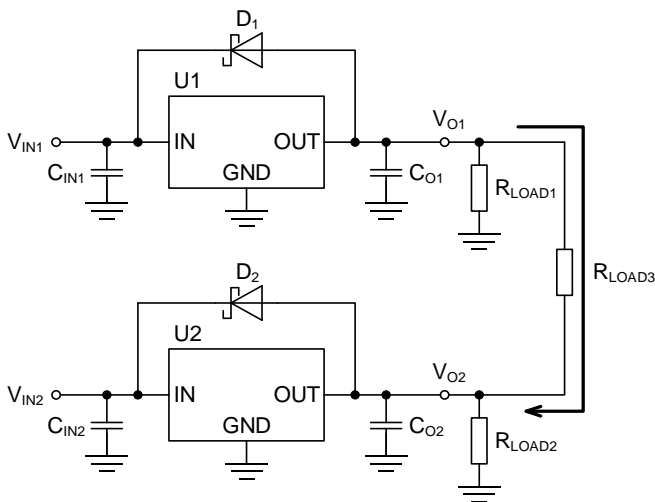

Figure 12-11. Current path and diode insertion between disparate power sources

6. Positive-negative power source (both power sources)

For positive-negative power supplies as shown in Figure 12-12, the speeds at which the power supplies rise are different. For this reason, when there is a load between positive and negative, the power source that started first pulls current from the other output through the positive voltage regulator's negative voltage to the output. Be sure to connect a Schottky barrier diode with a low V_F between the output and GND, to prevent damage to the IC and to prevent the output voltage from failing to rise.

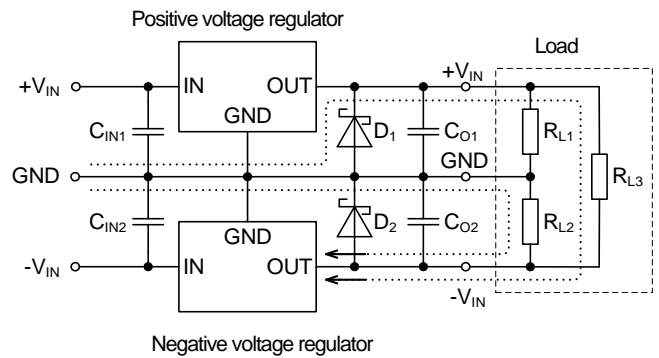

Figure 12-12. Inserting a diode between positive-negative power supplies; current path when negative power supply regulator starts first

13. Soft start

By starting the output voltage for a fixed interval when the power is turned on, the maximum value of inrush current that charges the output capacitor can be reduced. The rise time during soft start is fixed within the IC at 800 μs (typ). For this reason, the time cannot be adjusted externally. As shown in figure 13-1, the soft start time is defined as the time until the output voltage reaches the default value of 95%, with the origin as the point at which EN turns on from Low to High. For reference, the variations in time are as follows: 400 μs min, 800 μs standard, 1200 μs max. The soft start time is not dependent on the output voltage. Note that the start time may differ depending on the rise times for V_{CC} and EN, as well as the capacitance of the output capacitor. Refer to “Sequence for turning power supply on” for more details.

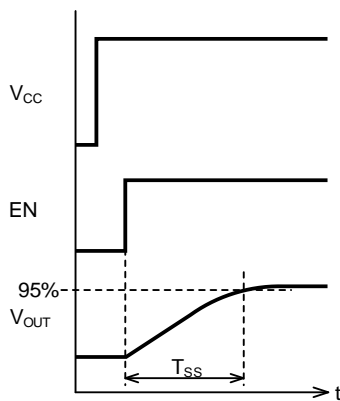

Figure 13-1. Definition of soft start time

14. Sequence for turning power on

There are no restrictions on the start sequence for V_{CC} and EN. The starting time depends on the rising time for V_{CC} and CTL, as well as the capacitance of the output capacitor. These differences are shown below.

1. When the circuit turns on in order of $V_{CC} \rightarrow EN$

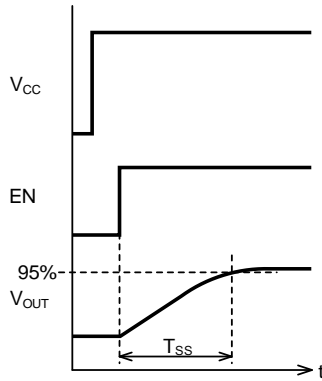

Figure 14-1.
When EN turns on abruptly

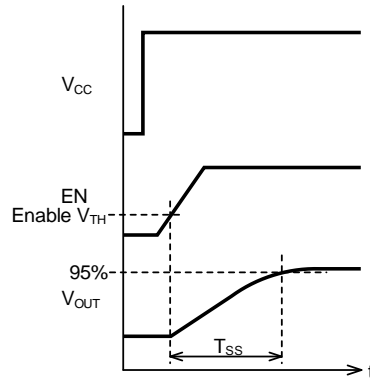

Figure 14-2.
When EN is turned on
before the soft start time

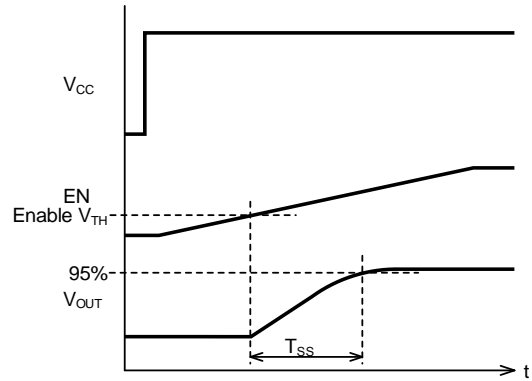

Figure 14-3.
When EN is turned on
after the soft start time

Figure 14-1 shows the startup characteristics for when EN abruptly turns on after V_{CC} rises. At the same time, this shows the soft start time definition. The soft start time is the time until the output voltage reaches the default value of 95%, with the origin as the point at which EN turns on from Low to High.

Figure 14-2 shows the startup characteristics for when EN is turned on before the soft start time. The soft start circuit begins operating from the time that the voltage of EN exceeds the threshold value, and the output voltage rises in accordance with the soft start time.

Figure 14-3 shows the startup characteristics for when EN is turned on after the soft start time. The soft start circuit begins operating from the time that the voltage of EN exceeds the threshold value, and the output voltage rises in accordance with the soft start time.

14. Sequence for turning power on (continued)

2. When the circuit turns on in order of EN → VCC

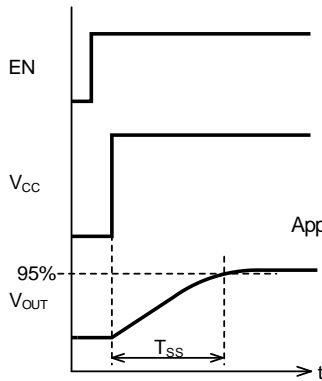

Figure 14-4.
When V_{CC} turns on abruptly

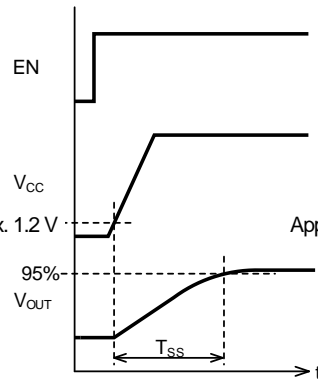

Figure 14-5.
When V_{CC} is turned on
before the soft start time

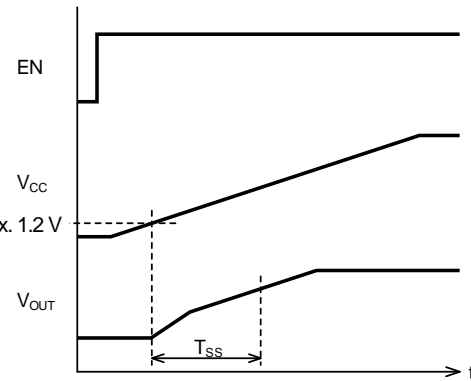

Figure 14-6.
When V_{CC} is turned on
after the soft start time

Figure 14-4 shows the startup characteristics when V_{CC} abruptly turns on after the EN rises. The soft start circuit begins operating from the time that the voltage of V_{CC} rises, and the output voltage rises in accordance with the soft start time.

Figure 14-5 shows the startup characteristics for when V_{CC} is turned on before the soft start time. The soft start circuit begins operating from the time that V_{CC} exceeds 1.2 V, and the output voltage rises in accordance with the soft start time.

Figure 14-6 shows the startup characteristics for when V_{CC} is turned on after the soft start time. The soft start circuit begins operating and the output rises from the time when the voltage of V_{CC} exceeds approximately 1.2 V. However, since the speed at which the voltage of V_{CC} rises is slower than the speed at which the voltage rises during soft start, the output voltage rise is restricted by the voltage of V_{CC}. For this reason, the start time will be longer and will exceed the soft start time.

14. Sequence for turning power on (continued)

3. When V_{CC} and EN turn on at the same time

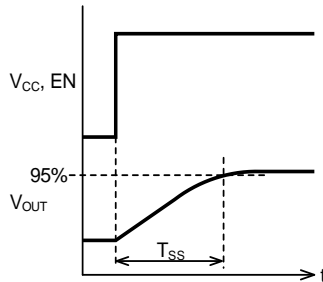

Figure 14-7.
When V_{CC} and EN turns on abruptly

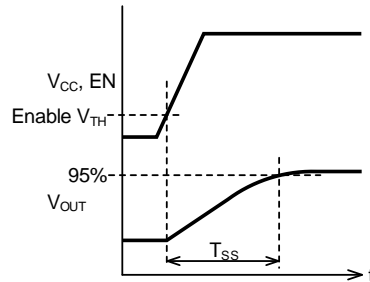

Figure 14-8.
When V_{CC} and EN are turned on before the soft start time

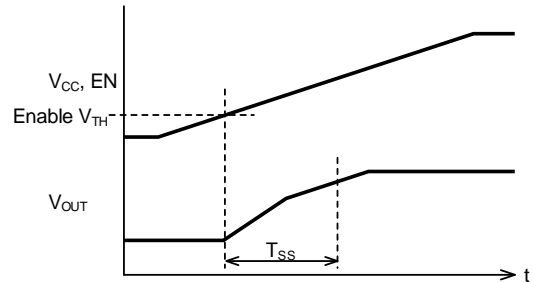

Figure 14-9.
When V_{CC} and EN are turned on after the soft start time

Figure 14-7 shows the startup characteristics when V_{CC} and EN are abruptly turned on at the same time. The soft start circuit begins operating from the time that V_{CC} and EN rise, and the output voltage rises in accordance with the soft start time.

Figure 14-8 shows the startup characteristics for when V_{CC} and EN are turned on before the soft start time. The soft start circuit begins operating from the time that the voltage of EN exceeds the threshold value, and the output voltage rises in accordance with the soft start time.

Figure 14-9 shows the startup characteristics for when V_{CC} and EN are turned on after the soft start time. The soft start circuit begins operating and the output begins to rise from the time when the voltage of EN exceeds the threshold value. However, since the speed at which the voltage of V_{CC} rises is slower than the speed at which the voltage rises during soft start, the output voltage rise is restricted by the voltage of V_{CC} . For this reason, the start time will be longer and will exceed the soft start time.

14. Sequence for turning power on (continued)

4. When the output capacitor's capacitance is large

When the capacitance of the output capacitor increases, the charging current at start time also increases. Although this changes depending on the output voltage and over current protection circuit limits, the charging current generally changes when the output capacitance is around several μF to first half of several hundred μF , but the soft start time remains the same when starting. When the output capacitance equals or is greater than around the first half of several hundred μF , the over current protection circuit activates according to the increase in charging current. Due to this, the charging current value is limited by the over current protection circuit. For this reason, the start time will be longer and will exceed the soft start time, as shown in Figure 14-10. In this condition, the start time will grow longer along with the increase in output capacitance. Figure 14-11 shows the condition in which the current limit affects the start partway through due to the over current protection circuit. In this case, the charging current decreases when the charging of the capacitor is completed to a certain extent. Due to this, the over current protection is released, and the circuit returns to normal operations. This condition occurs when the capacitance of the output capacitor is between the ranges shown in Figure 14-7 and Figure 14-10. When the output capacitor's capacitance is large, check the start time with the actual operating conditions.

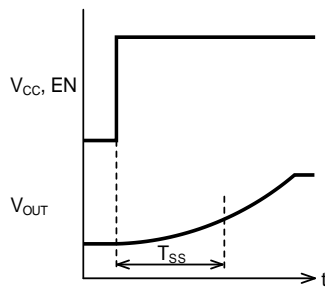

Figure 14-10.
When starting while the current limit is applied by the over current protection circuit

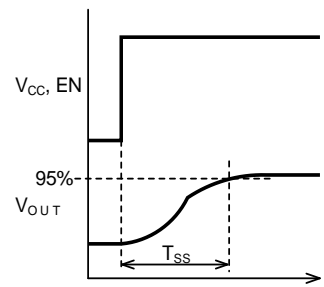

Figure 14-11.
When starting while the current limit is applied partway through by the over current protection circuit

15. Sequence for turning power off

The output voltage fall times differ, depending on the order in which V_{CC} and EN are turned off. These differences are shown below.

1. When the circuit turns off in order of EN → V_{CC}

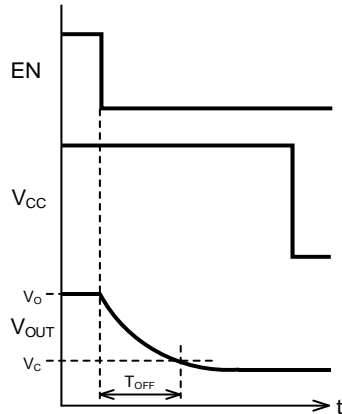

Figure 15-1.
When EN turns off abruptly

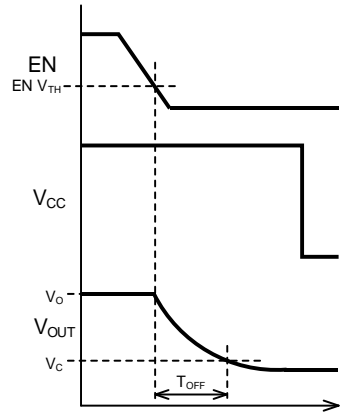

Figure 15-2.
When EN turns off gradually

Figure 15-1 shows the startup characteristics when EN abruptly turns off at the same time. When EN goes off, the output transistor will turn off, and the supply of electrical charge from input to output will be gone. The electrical charge in the output capacitor is discharged due to the load, and the output voltage will fall. Another discharge path besides the load is the feedback resistor (output voltage setting resistor). V_{CC} turns off when the output voltage fully drops. For resistance with a simple load, the output voltage falling time can be calculated with the following equation.

$$T_{OFF} = -C_O \times R_L \times \ln\left(\frac{V_C}{V_O}\right) \quad [sec] \quad (15-1)$$

C_O : Output capacitor [F]

R_L : Load resistance [Ω]

V_O : Output voltage [V]

V_C : Final dropped voltage [V]

Figure 15-2 shows the power off characteristics when EN gradually turns off. The output transistor turns off when the voltage of EN falls below the threshold value. The output voltage will fall. The fall time for the output voltage is the same as that shown on Figure 15-1.

15. Sequence for turning power off (continued)

2. When the circuit turns off in order of $V_{CC} \rightarrow EN$

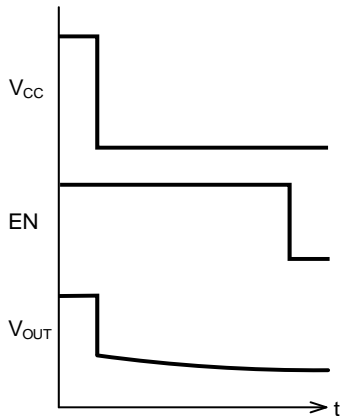

Figure 15-3.
When V_{CC} turns off abruptly

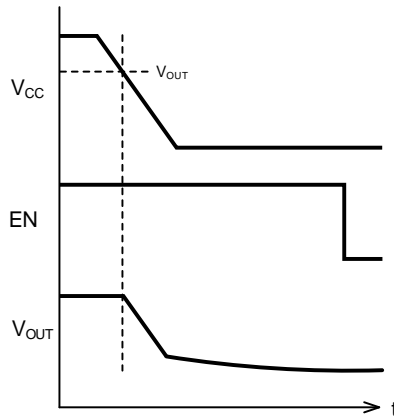

Figure 15-4.
When V_{CC} turns off gradually

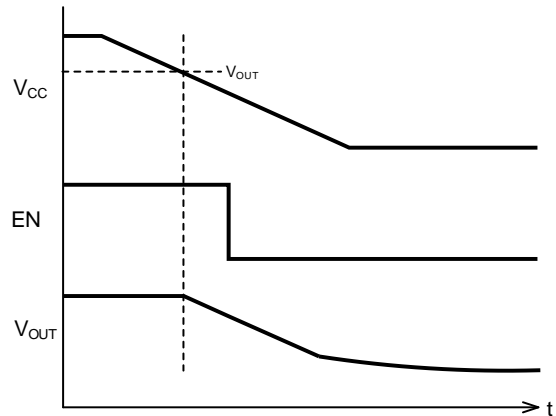

Figure 15-5.
When V_{CC} turns off gradually, and EN turns off while V_{CC} is falling

Figure 15-3 shows the power off characteristics when V_{CC} abruptly turns off. When V_{CC} abruptly turns off, the electrical charge of the output capacitor is shunted to the input side through the output transistor body diode (parasitic diode), in order to invert the input/output voltage. As a result, the output voltage abruptly falls following the input voltage; and when V_{CC} reaches 0 V, the body diode voltage (approximately 0.5 V) is left and falls gradually. Then, the voltage falls in time constant with the load resistance.

Figure 15-4 shows the power off characteristics when V_{CC} gradually turns off. When the voltage of V_{CC} falls, the electrical charge of the output capacitor is shunted to the input side through the output transistor body diode (parasitic diode), when the input/output voltage reaches the inversion point. As a result, the output voltage falls following the input voltage; and when V_{CC} reaches 0 V, the body diode voltage (approximately 0.5 V) is left and falls even more gradually. Then, the voltage falls in time constant with the load resistance.

Figure 15-5 shows the power off characteristics when EN abruptly turns off while V_{CC} gradually turns off. When the voltage of V_{CC} falls, the electrical charge of the output capacitor is shunted to the input side through the output transistor body diode (parasitic diode), when the input/output voltage reaches the inversion point. Thus, the output voltage falls following the input voltage. When EN is abruptly turned off while the V_{CC} voltage is falling, the transistor will turn off. However, as the input/output voltage will be inverted, the output voltage continues to fall following the input voltage. Note that when the load current is large, the output voltage will fall faster according to as the current value increases. When the V_{CC} reaches 0 V, the body diode voltage (approximately 0.5 V) is left and falls even more gradually. Then, the voltage falls in time constant with the load resistance.

15. Sequence for turning power off (continued)

3. When V_{CC} and EN turn off at the same time

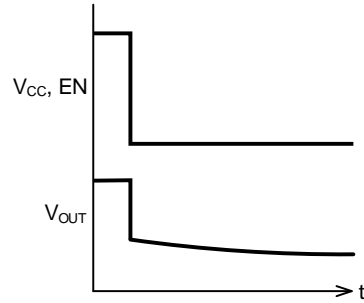

Figure 15-6.
When V_{CC} and EN turn off abruptly

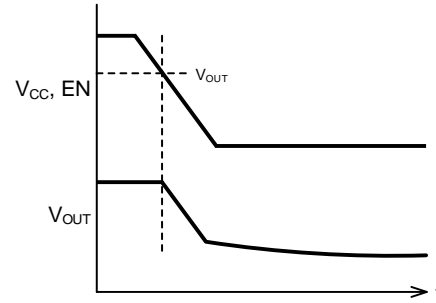

Figure 15-7.
When V_{CC} and EN turn off gradually

Figure 15-6 shows the power off characteristics when V_{CC} and EN abruptly turn off. When V_{CC} abruptly turns off, the electrical charge of the output capacitor is shunted to the input side through the output transistor body diode (parasitic diode), in order to invert the input/output voltage. As a result, the output voltage abruptly falls following the input voltage; and when V_{CC} reaches 0 V, the body diode voltage (approximately 0.5 V) is left and falls gradually. Then, the voltage falls in time constant with the load resistance.

Figure 15-7 shows the power off characteristics when V_{CC} and EN gradually turn off. When the voltage of V_{CC} falls and the input/output voltage reaches the inversion point, the electrical charge of the output capacitor is shunted to the input side through the output transistor body diode (parasitic diode). As a result, the output voltage falls following the input voltage; and when V_{CC} reaches 0 V, the body diode voltage (approximately 0.5 V) is left and falls even more gradually. Then, the voltage falls in time constant with the load resistance.

16. Inrush current

An inrush current flows to electrically charge the output capacitor of the IC during startup. Even if the output current value exceeds the maximum value of the recommended operating range, the over current protection (OCP) circuit limits the current, so there are no problems in operation. Note that it is necessary to make sure that the IC junction temperature does not exceed 150°C due to overcurrent. The junction temperature T_J during short-term overcurrent can be estimated by the following equation using the transient thermal resistance Z_{TH} .

$$T_J = T_A + Z_{TH} \times P \quad [^\circ\text{C}] \quad (16-1)$$

T_A : Ambient temperature [$^\circ\text{C}$]

Z_{TH} : Transient thermal resistance between junction and ambient temperature [$^\circ\text{C}/\text{W}$]

P : IC consumption power [W]

P can be calculated by the IC consumption power using the following equation.

$$P = (V_{CC} - V_{OUT}) \times I_{OUT} + (V_{CC} \times I_{CC}) \quad [\text{W}] \quad (16-2)$$

Note that when $I_{OUT} \gg I_{CC}$, the following equation is used.

$$P = (V_{CC} - V_{OUT}) \times I_{OUT} \quad [\text{W}] \quad (16-3)$$

V_{CC} : Input voltage [V]

V_{OUT} : Output voltage [V]

I_{OUT} : Output current [A]

I_{CC} : IC circuit current [A]

In the HTSOP-J8 package, considering that 0.6 A of inrush current at an ambient temperature of $T_A=60^\circ\text{C}$ flows for 1 ms, the transient thermal resistance in 1 ms is $5^\circ\text{C}/\text{W}$ from Figure 16-1.

The junction temperature T_J is calculated as follows.

$$\begin{aligned} T_J &= T_A + Z_{TH} \times P \\ &= 60^\circ\text{C} + 5 \times (5\text{ V} - 3.3\text{ V}) \times 0.6\text{ A} = 65.1^\circ\text{C} \end{aligned}$$

The junction temperature T_J is 150°C or less, so there is no problem.

In this way, since the rise in chip temperature is slight when the inrush current is around 1 ms (a short time), problems with rising temperatures are minimal.

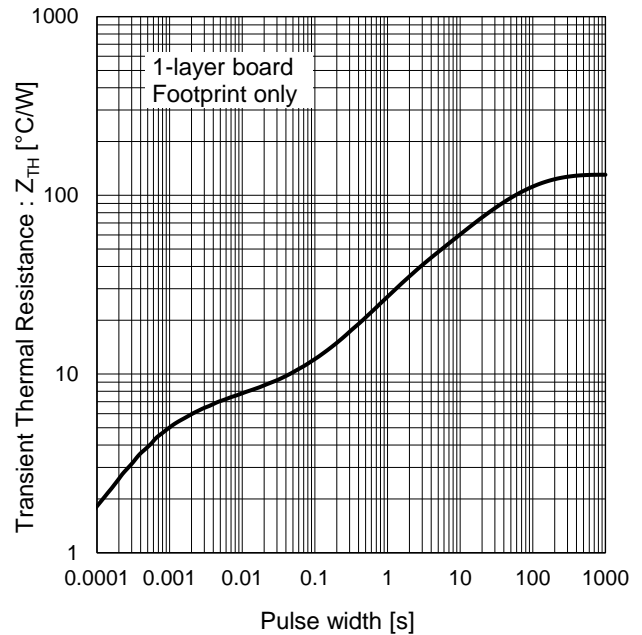

Figure 16-1. Transient thermal resistance of the HTSOP-J8 package

17. Over current protection (OCP)

An over current protection circuit is included, in order to prevent IC breakdown due to overcurrent when the IC output shorts out the GND. This protective function prevents the IC from breaking down; thus, when used for the purpose of protection as per the original set, we consider that it will be used on a fuse or other current limit device.

The over current protection characteristics are as shown in Figure 17-1, and the characteristics look like a number “7” (or a “fold back characteristic” in English). The reference value for point A at over current protection detected current is approximately 0.6 A. The lower limit value for variations in the detected current will not fall below the maximum value of the recommended output current. When overcurrent is detected, the current fold back circuit operates, and the output voltage drops. Along with the drop in output voltage, the circuit repeatedly works to limit the current, reaching point B. Point B is the output short circuit current. As for the power loss at point B, we can say that this is a safe protection circuit that protects the IC from breaking down, due to small power loss and a smaller degree of heat. Note that this condition will continue until the cause of the overcurrent is eliminated. The output voltage is automatically restored when the overcurrent condition is removed.

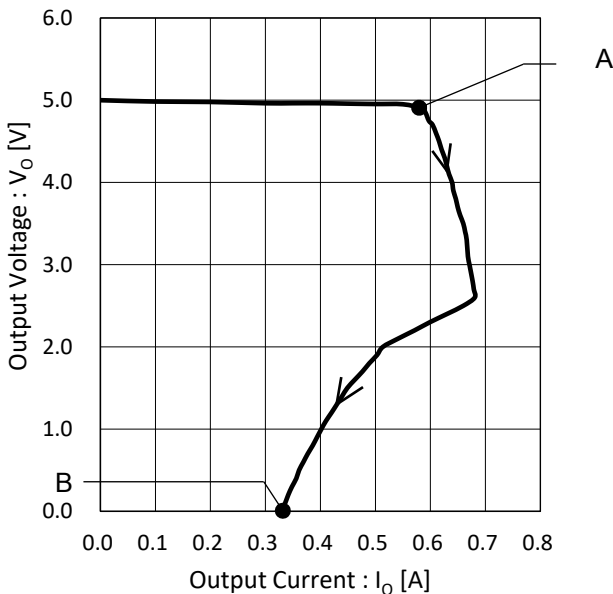

Figure 17-1. Characteristics of over current protection

The region between the maximum value of the recommended output current and the over current protection detected value operates as a linear regulator. However, the electrical characteristics are not guaranteed. When continuing to operate beyond the power dissipation, the thermal shutdown circuit will activate and shut off the output.

18. Thermal shutdown (TSD)

Thermal shutdown protects the IC from damage due to overheating, which occurs when the IC chip temperature exceeds the junction temperature due to an output short or increased power loss. This is not intended to supplant the original thermal shutdown feature of the set.

When the thermal shutdown circuit exceeds the reference value of approximately 175°C, the regulator output turns off, shutting off the output current and lowering the chip temperature. Although there are variations in the detected temperature, this will never fall below the junction temperature (150°C). If the chip temperature falls to approximately 160°C, the output turns on again, and the output current supply begins. The output will turn on and off repeatedly until the cause of the rise in chip temperature is eliminated. If this condition continues, the IC will not break down right away, but continued operation should be avoided, as it will lead to degradation or breakdown.

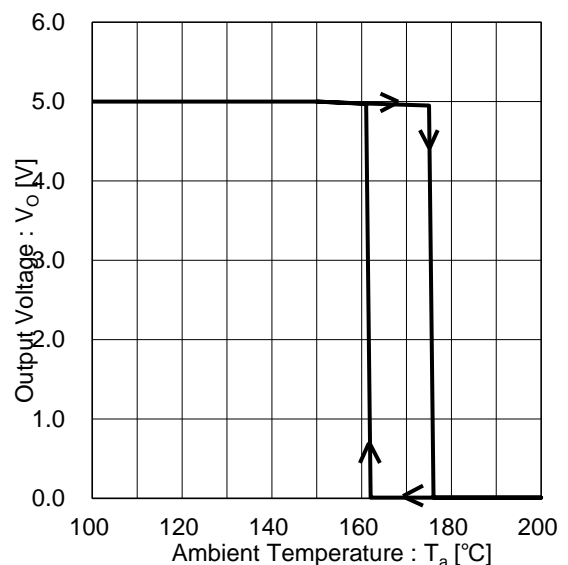

Figure 18-1. Thermal shutdown characteristics

19. Input-output equivalent circuit

Adjustable output type

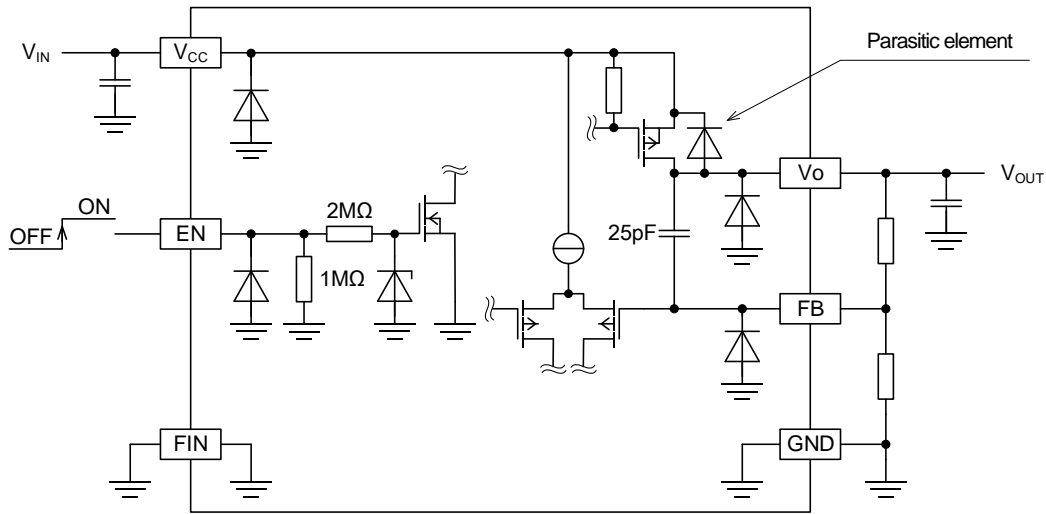
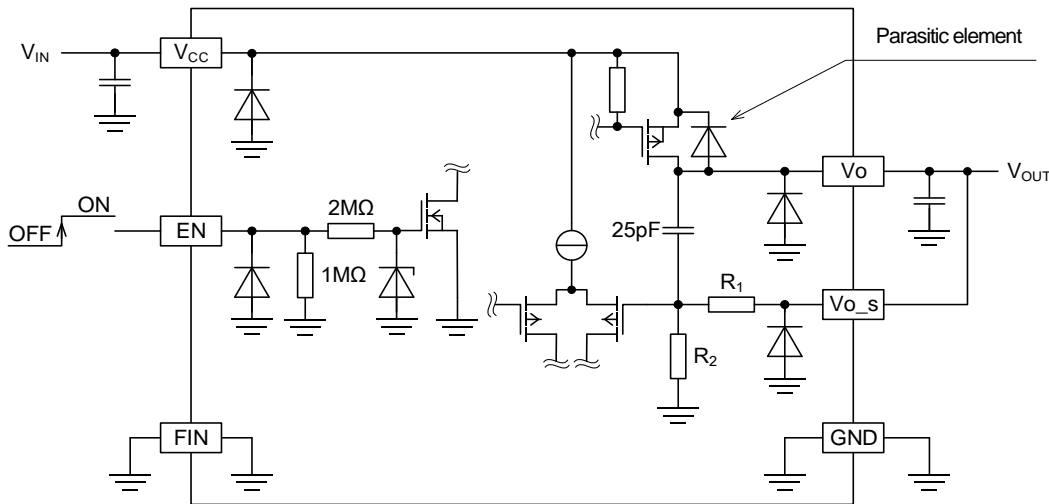

Figure 19-1. Adjustable output type equivalent circuit

Fixed output type



Type	R ₁ (kΩ)	R ₂ (kΩ)
BD15GA3	30.1	34.4
BD18GA3	43.0	34.4
BD25GA3	54.8	25.8
BD30GA3	47.3	17.2
BD33GA3	80.6	25.8
BD50GA3	33.9	6.45

Type	R ₁ (kΩ)	R ₂ (kΩ)
BD60GA3	41.9	6.45
BD70GA3	100	12.9
BD80GA3	38.7	4.30
BD90GA3	132	12.9
BDJ0GA3	74.2	6.45
BDJ2GA3	90.3	6.45

Figure 19-2. Fixed output type equivalent circuit

20. Lineup

This series is designed to be pin-compatible, and can be easily replaced if the input voltage or output current specs have been modified.

Series	Input Voltage Maximum Rating (V)	Input Voltage Range (V)	Output Current (A)	Operating Temperature (°C)	Grade				
					Consumer	Industrial	Automotive		
BDxxGC0WEFJ	15	4.5 to 14	1.0	-25 to +85	✓	-	-		
BDxxGC0MEFJ -LB				-40 to +105	-	✓	-		
BDxxGC0MEFJ -M				-40 to +105	-	-	✓		
BDxxGA5WEFJ			15	4.5 to 14	0.5	-25 to +85	✓	-	-
BDxxGA5MEFJ -LB						-40 to +105	-	✓	-
BDxxGA5MEFJ -M						-40 to +105	-	-	✓
BDxxGA3WEFJ					0.3	-25 to +85	✓	-	-
BDxxGA3MEFJ -LB						-40 to +105	-	✓	-
BDxxGA3MEFJ -M						-40 to +105	-	-	✓
BDxxHC5WEFJ	10	4.5 to 8	1.5	-25 to +85	✓	-	-		
BDxxHC5MEFJ -LB				-40 to +105	-	✓	-		
BDxxHC5MEFJ -M				-40 to +105	-	-	✓		
BDxxHC0WEFJ			1.0	-25 to +85	✓	-	-		
BDxxHC0MEFJ -LB				-40 to +105	-	✓	-		
BDxxHC0MEFJ -M				-40 to +105	-	-	✓		
BDxxHA5WEFJ			10	4.5 to 8	0.5	-25 to +85	✓	-	-
BDxxHA5MEFJ -LB						-40 to +105	-	✓	-
BDxxHA5MEFJ -M						-40 to +105	-	-	✓
BDxxHA3WEFJ					0.3	-25 to +85	✓	-	-
BDxxHA3MEFJ -LB						-40 to +105	-	✓	-
BDxxHA3MEFJ -M						-40 to +105	-	-	✓
BDxxIC0WEFJ			7	2.4 to 5.5	1.0	-25 to +85	✓	-	-
BDxxIC0MEFJ -LB						-40 to +105	-	✓	-
BDxxIC0MEFJ -M						-40 to +105	-	-	✓
BDxxIA5WEFJ	0.5	-25 to +85			✓	-	-		
BDxxIA5MEFJ -LB		-40 to +105			-	✓	-		
BDxxIA5MEFJ -M		-40 to +105			-	-	✓		

Notes

- 1) The information contained herein is subject to change without notice.
- 2) Before you use our Products, please contact our sales representative and verify the latest specifications :
- 3) Although ROHM is continuously working to improve product reliability and quality, semiconductors can break down and malfunction due to various factors.
Therefore, in order to prevent personal injury or fire arising from failure, please take safety measures such as complying with the derating characteristics, implementing redundant and fire prevention designs, and utilizing backups and fail-safe procedures. ROHM shall have no responsibility for any damages arising out of the use of our Products beyond the rating specified by ROHM.
- 4) Examples of application circuits, circuit constants and any other information contained herein are provided only to illustrate the standard usage and operations of the Products. The peripheral conditions must be taken into account when designing circuits for mass production.
- 5) The technical information specified herein is intended only to show the typical functions of and examples of application circuits for the Products. ROHM does not grant you, explicitly or implicitly, any license to use or exercise intellectual property or other rights held by ROHM or any other parties. ROHM shall have no responsibility whatsoever for any dispute arising out of the use of such technical information.
- 6) The Products specified in this document are not designed to be radiation tolerant.
- 7) For use of our Products in applications requiring a high degree of reliability (as exemplified below), please contact and consult with a ROHM representative : transportation equipment (i.e. cars, ships, trains), primary communication equipment, traffic lights, fire/crime prevention, safety equipment, medical systems, servers, solar cells, and power transmission systems.
- 8) Do not use our Products in applications requiring extremely high reliability, such as aerospace equipment, nuclear power control systems, and submarine repeaters.
- 9) ROHM shall have no responsibility for any damages or injury arising from non-compliance with the recommended usage conditions and specifications contained herein.
- 10) ROHM has used reasonable care to ensure the accuracy of the information contained in this document. However, ROHM does not warrants that such information is error-free, and ROHM shall have no responsibility for any damages arising from any inaccuracy or misprint of such information.
- 11) Please use the Products in accordance with any applicable environmental laws and regulations, such as the RoHS Directive. For more details, including RoHS compatibility, please contact a ROHM sales office. ROHM shall have no responsibility for any damages or losses resulting non-compliance with any applicable laws or regulations.
- 12) When providing our Products and technologies contained in this document to other countries, you must abide by the procedures and provisions stipulated in all applicable export laws and regulations, including without limitation the US Export Administration Regulations and the Foreign Exchange and Foreign Trade Act.
- 13) This document, in part or in whole, may not be reprinted or reproduced without prior consent of ROHM.



Thank you for your accessing to ROHM product informations.
More detail product informations and catalogs are available, please contact us.

ROHM Customer Support System

<http://www.rohm.com/contact/>